

| | | | | | | | | | | | | | | | | | | | | | | | | | |
|---------------------|--|----|-----|---|----|------|---|----|------|---|----|------|---|----|------|---|----|------|---|----|------|---|----|-------|---|
| <p>Prøve</p> | <table style="width:100%; border-collapse: collapse;"> <tr><td style="width:10%;">1:</td><td style="width:40%;">9.7</td><td style="width:50%; text-align: right;">↓</td></tr> <tr><td>2:</td><td>10.1</td><td style="text-align: right;">↓</td></tr> <tr><td>3:</td><td>10.5</td><td style="text-align: right;">→</td></tr> <tr><td>4:</td><td>10.1</td><td style="text-align: right;">↓</td></tr> <tr><td>5:</td><td>10.1</td><td style="text-align: right;">←</td></tr> <tr><td>6:</td><td>10.6</td><td style="text-align: right;">↓</td></tr> <tr><td>7:</td><td>10.2</td><td style="text-align: right;">←</td></tr> <tr><td>8:</td><td>*10.6</td><td style="text-align: right;">↑</td></tr> </table> | 1: | 9.7 | ↓ | 2: | 10.1 | ↓ | 3: | 10.5 | → | 4: | 10.1 | ↓ | 5: | 10.1 | ← | 6: | 10.6 | ↓ | 7: | 10.2 | ← | 8: | *10.6 | ↑ |
| 1: | 9.7 | ↓ | | | | | | | | | | | | | | | | | | | | | | | |
| 2: | 10.1 | ↓ | | | | | | | | | | | | | | | | | | | | | | | |
| 3: | 10.5 | → | | | | | | | | | | | | | | | | | | | | | | | |
| 4: | 10.1 | ↓ | | | | | | | | | | | | | | | | | | | | | | | |
| 5: | 10.1 | ← | | | | | | | | | | | | | | | | | | | | | | | |
| 6: | 10.6 | ↓ | | | | | | | | | | | | | | | | | | | | | | | |
| 7: | 10.2 | ← | | | | | | | | | | | | | | | | | | | | | | | |
| 8: | *10.6 | ↑ | | | | | | | | | | | | | | | | | | | | | | | |

| | |
|-------|------|
| Serie | 79.0 |
|-------|------|

| | |
|-------|-----|
| Total | 0.0 |
|-------|-----|

| | | | | | | | | | | | | | | | | | | | | | | | | | | | | | | | |
|-----------------------|---|----|------|---|----|------|---|----|-----|---|----|------|---|----|------|---|----|-------|---|----|------|---|----|------|---|----|-----|---|-----|-------|---|
| <p>20 Skud</p> | <table style="width:100%; border-collapse: collapse;"> <tr><td style="width:10%;">1:</td><td style="width:40%;">10.3</td><td style="width:50%; text-align: right;">↓</td></tr> <tr><td>2:</td><td>10.6</td><td style="text-align: right;">→</td></tr> <tr><td>3:</td><td>9.8</td><td style="text-align: right;">→</td></tr> <tr><td>4:</td><td>10.1</td><td style="text-align: right;">↑</td></tr> <tr><td>5:</td><td>10.1</td><td style="text-align: right;">↓</td></tr> <tr><td>6:</td><td>*10.8</td><td style="text-align: right;">↑</td></tr> <tr><td>7:</td><td>10.4</td><td style="text-align: right;">↓</td></tr> <tr><td>8:</td><td>10.0</td><td style="text-align: right;">→</td></tr> <tr><td>9:</td><td>9.9</td><td style="text-align: right;">←</td></tr> <tr><td>10:</td><td>*10.7</td><td style="text-align: right;">↓</td></tr> </table> | 1: | 10.3 | ↓ | 2: | 10.6 | → | 3: | 9.8 | → | 4: | 10.1 | ↑ | 5: | 10.1 | ↓ | 6: | *10.8 | ↑ | 7: | 10.4 | ↓ | 8: | 10.0 | → | 9: | 9.9 | ← | 10: | *10.7 | ↓ |
| 1: | 10.3 | ↓ | | | | | | | | | | | | | | | | | | | | | | | | | | | | | |
| 2: | 10.6 | → | | | | | | | | | | | | | | | | | | | | | | | | | | | | | |
| 3: | 9.8 | → | | | | | | | | | | | | | | | | | | | | | | | | | | | | | |
| 4: | 10.1 | ↑ | | | | | | | | | | | | | | | | | | | | | | | | | | | | | |
| 5: | 10.1 | ↓ | | | | | | | | | | | | | | | | | | | | | | | | | | | | | |
| 6: | *10.8 | ↑ | | | | | | | | | | | | | | | | | | | | | | | | | | | | | |
| 7: | 10.4 | ↓ | | | | | | | | | | | | | | | | | | | | | | | | | | | | | |
| 8: | 10.0 | → | | | | | | | | | | | | | | | | | | | | | | | | | | | | | |
| 9: | 9.9 | ← | | | | | | | | | | | | | | | | | | | | | | | | | | | | | |
| 10: | *10.7 | ↓ | | | | | | | | | | | | | | | | | | | | | | | | | | | | | |

| | |
|-------|------|
| Serie | 98.0 |
|-------|------|

| | |
|-------|------|
| Total | 98.0 |
|-------|------|

| | | | | | | | | | | | | | | | | | | | | | | | | | | | | | | | |
|-----------------------|--|-----|------|---|-----|------|---|-----|-------|---|-----|------|---|-----|------|---|-----|-------|---|-----|------|---|-----|-----|---|-----|------|---|-----|-------|---|
| <p>20 Skud</p> | <table style="width:100%; border-collapse: collapse;"> <tr><td style="width:10%;">11:</td><td style="width:40%;">10.4</td><td style="width:50%; text-align: right;">↙</td></tr> <tr><td>12:</td><td>10.3</td><td style="text-align: right;">↑</td></tr> <tr><td>13:</td><td>*10.6</td><td style="text-align: right;">↓</td></tr> <tr><td>14:</td><td>10.1</td><td style="text-align: right;">↓</td></tr> <tr><td>15:</td><td>10.5</td><td style="text-align: right;">↓</td></tr> <tr><td>16:</td><td>*10.7</td><td style="text-align: right;">↗</td></tr> <tr><td>17:</td><td>10.5</td><td style="text-align: right;">↓</td></tr> <tr><td>18:</td><td>9.9</td><td style="text-align: right;">↙</td></tr> <tr><td>19:</td><td>10.4</td><td style="text-align: right;">→</td></tr> <tr><td>20:</td><td>*10.6</td><td style="text-align: right;">↙</td></tr> </table> | 11: | 10.4 | ↙ | 12: | 10.3 | ↑ | 13: | *10.6 | ↓ | 14: | 10.1 | ↓ | 15: | 10.5 | ↓ | 16: | *10.7 | ↗ | 17: | 10.5 | ↓ | 18: | 9.9 | ↙ | 19: | 10.4 | → | 20: | *10.6 | ↙ |
| 11: | 10.4 | ↙ | | | | | | | | | | | | | | | | | | | | | | | | | | | | | |
| 12: | 10.3 | ↑ | | | | | | | | | | | | | | | | | | | | | | | | | | | | | |
| 13: | *10.6 | ↓ | | | | | | | | | | | | | | | | | | | | | | | | | | | | | |
| 14: | 10.1 | ↓ | | | | | | | | | | | | | | | | | | | | | | | | | | | | | |
| 15: | 10.5 | ↓ | | | | | | | | | | | | | | | | | | | | | | | | | | | | | |
| 16: | *10.7 | ↗ | | | | | | | | | | | | | | | | | | | | | | | | | | | | | |
| 17: | 10.5 | ↓ | | | | | | | | | | | | | | | | | | | | | | | | | | | | | |
| 18: | 9.9 | ↙ | | | | | | | | | | | | | | | | | | | | | | | | | | | | | |
| 19: | 10.4 | → | | | | | | | | | | | | | | | | | | | | | | | | | | | | | |
| 20: | *10.6 | ↙ | | | | | | | | | | | | | | | | | | | | | | | | | | | | | |

| | |
|-------|------|
| Serie | 99.0 |
|-------|------|

| | |
|-------|-------|
| Total | 197.0 |
|-------|-------|

Hold
20Skive
2

Emma Myrup Langgaard

Løgstør Skyttelaug

BK2

Prøve

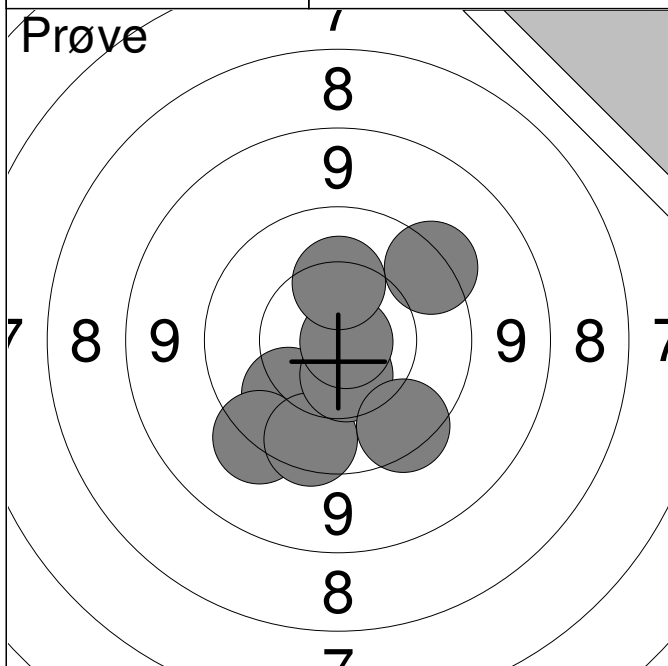

| | | |
|----|-------|---|
| 1: | 10.1 | ↙ |
| 2: | 9.5 | ↙ |
| 3: | 9.7 | ↙ |
| 4: | 10.5 | ↙ |
| 5: | 9.7 | ↙ |
| 6: | 9.5 | ↗ |
| 7: | *10.9 | → |
| 8: | 10.3 | ↑ |

Serie 76.0

Total 0.0

20 Skud

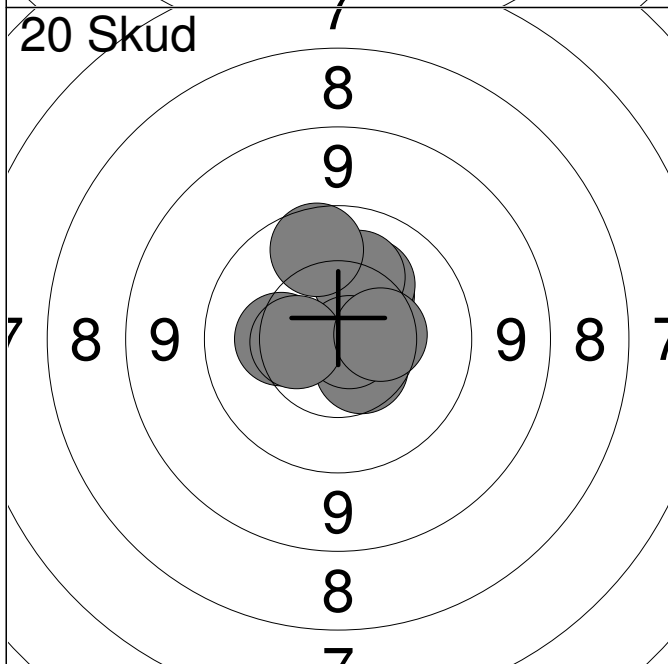

| | | |
|-----|-------|---|
| 1: | 10.6 | → |
| 2: | 10.3 | ↗ |
| 3: | 10.2 | ↗ |
| 4: | 10.5 | ↙ |
| 5: | 10.3 | ← |
| 6: | 10.2 | ↑ |
| 7: | *10.8 | → |
| 8: | 10.5 | ← |
| 9: | 10.5 | → |
| 10: | 9.9 | ↑ |

Serie 99.0

Total 99.0

20 Skud

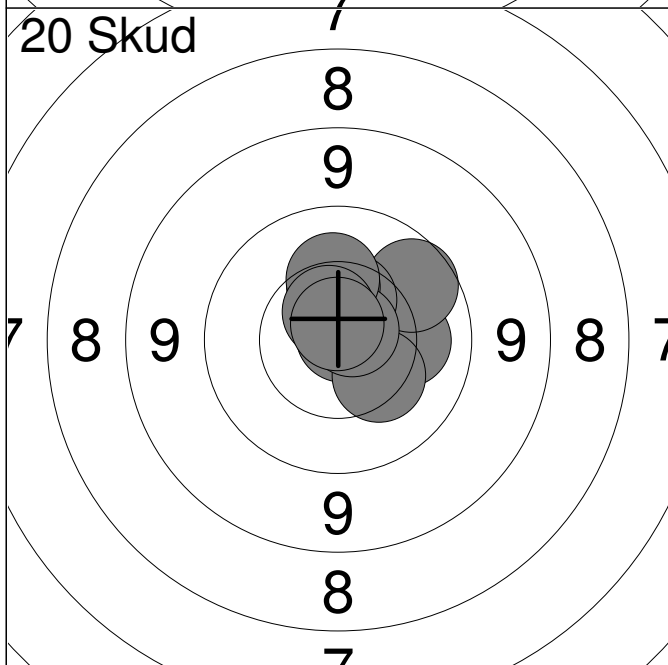

| | | |
|-----|-------|---|
| 11: | *10.9 | ↗ |
| 12: | 10.2 | → |
| 13: | 9.9 | ↗ |
| 14: | 10.5 | ↑ |
| 15: | 10.3 | ↑ |
| 16: | 10.3 | ↙ |
| 17: | *10.7 | ↗ |
| 18: | 10.2 | ↑ |
| 19: | *10.6 | ↑ |
| 20: | *10.8 | ↑ |

Serie 99.0

Total 198.0

| | | | | | | | | | | | | | | | | | | | | | | | | | |
|---------------------|--|-------|------|------|-------|-------|-----|----|-------|---|----|------|---|----|-------|---|----|-------|---|----|-----|---|----|------|---|
| <p>Prøve</p> | <table style="width:100%; border-collapse: collapse;"> <tr><td style="width:5%;">1:</td><td style="width:15%;">10.0</td><td style="width:10%; text-align: center;">↗</td></tr> <tr><td>2:</td><td>*10.6</td><td style="text-align: center;">←</td></tr> <tr><td>3:</td><td>*10.5</td><td style="text-align: center;">←</td></tr> <tr><td>4:</td><td>10.3</td><td style="text-align: center;">↗</td></tr> <tr><td>5:</td><td>*10.8</td><td style="text-align: center;">←</td></tr> <tr><td>6:</td><td>*10.7</td><td style="text-align: center;">←</td></tr> <tr><td>7:</td><td>9.8</td><td style="text-align: center;">←</td></tr> <tr><td>8:</td><td>10.2</td><td style="text-align: center;">↘</td></tr> </table> | 1: | 10.0 | ↗ | 2: | *10.6 | ← | 3: | *10.5 | ← | 4: | 10.3 | ↗ | 5: | *10.8 | ← | 6: | *10.7 | ← | 7: | 9.8 | ← | 8: | 10.2 | ↘ |
| 1: | 10.0 | ↗ | | | | | | | | | | | | | | | | | | | | | | | |
| 2: | *10.6 | ← | | | | | | | | | | | | | | | | | | | | | | | |
| 3: | *10.5 | ← | | | | | | | | | | | | | | | | | | | | | | | |
| 4: | 10.3 | ↗ | | | | | | | | | | | | | | | | | | | | | | | |
| 5: | *10.8 | ← | | | | | | | | | | | | | | | | | | | | | | | |
| 6: | *10.7 | ← | | | | | | | | | | | | | | | | | | | | | | | |
| 7: | 9.8 | ← | | | | | | | | | | | | | | | | | | | | | | | |
| 8: | 10.2 | ↘ | | | | | | | | | | | | | | | | | | | | | | | |
| | <table border="1" style="width:100%; border-collapse: collapse;"> <tr> <td style="width:5%;">Serie</td> <td style="width:15%;"></td> <td style="width:10%; text-align: right;">79.0</td> </tr> <tr> <td>Total</td> <td></td> <td style="text-align: right;">0.0</td> </tr> </table> | Serie | | 79.0 | Total | | 0.0 | | | | | | | | | | | | | | | | | | |
| Serie | | 79.0 | | | | | | | | | | | | | | | | | | | | | | | |
| Total | | 0.0 | | | | | | | | | | | | | | | | | | | | | | | |

| | | | | | | | | | | | | | | | | | | | | | | | | | | | | | | | |
|-----------------------|---|-------|-------|-------|-------|-------|-------|----|-------|---|----|------|---|----|-------|---|----|------|---|----|------|---|----|-------|---|----|------|---|-----|------|---|
| <p>20 Skud</p> | <table style="width:100%; border-collapse: collapse;"> <tr><td style="width:5%;">1:</td><td style="width:15%;">*10.5</td><td style="width:10%; text-align: center;">←</td></tr> <tr><td>2:</td><td>*10.6</td><td style="text-align: center;">↘</td></tr> <tr><td>3:</td><td>*10.7</td><td style="text-align: center;">↘</td></tr> <tr><td>4:</td><td>10.4</td><td style="text-align: center;">↗</td></tr> <tr><td>5:</td><td>*10.7</td><td style="text-align: center;">→</td></tr> <tr><td>6:</td><td>10.4</td><td style="text-align: center;">↑</td></tr> <tr><td>7:</td><td>10.4</td><td style="text-align: center;">↗</td></tr> <tr><td>8:</td><td>*10.8</td><td style="text-align: center;">←</td></tr> <tr><td>9:</td><td>10.2</td><td style="text-align: center;">→</td></tr> <tr><td>10:</td><td>10.2</td><td style="text-align: center;">↘</td></tr> </table> | 1: | *10.5 | ← | 2: | *10.6 | ↘ | 3: | *10.7 | ↘ | 4: | 10.4 | ↗ | 5: | *10.7 | → | 6: | 10.4 | ↑ | 7: | 10.4 | ↗ | 8: | *10.8 | ← | 9: | 10.2 | → | 10: | 10.2 | ↘ |
| 1: | *10.5 | ← | | | | | | | | | | | | | | | | | | | | | | | | | | | | | |
| 2: | *10.6 | ↘ | | | | | | | | | | | | | | | | | | | | | | | | | | | | | |
| 3: | *10.7 | ↘ | | | | | | | | | | | | | | | | | | | | | | | | | | | | | |
| 4: | 10.4 | ↗ | | | | | | | | | | | | | | | | | | | | | | | | | | | | | |
| 5: | *10.7 | → | | | | | | | | | | | | | | | | | | | | | | | | | | | | | |
| 6: | 10.4 | ↑ | | | | | | | | | | | | | | | | | | | | | | | | | | | | | |
| 7: | 10.4 | ↗ | | | | | | | | | | | | | | | | | | | | | | | | | | | | | |
| 8: | *10.8 | ← | | | | | | | | | | | | | | | | | | | | | | | | | | | | | |
| 9: | 10.2 | → | | | | | | | | | | | | | | | | | | | | | | | | | | | | | |
| 10: | 10.2 | ↘ | | | | | | | | | | | | | | | | | | | | | | | | | | | | | |
| | <table border="1" style="width:100%; border-collapse: collapse;"> <tr> <td style="width:5%;">Serie</td> <td style="width:15%;"></td> <td style="width:10%; text-align: right;">100.0</td> </tr> <tr> <td>Total</td> <td></td> <td style="text-align: right;">100.0</td> </tr> </table> | Serie | | 100.0 | Total | | 100.0 | | | | | | | | | | | | | | | | | | | | | | | | |
| Serie | | 100.0 | | | | | | | | | | | | | | | | | | | | | | | | | | | | | |
| Total | | 100.0 | | | | | | | | | | | | | | | | | | | | | | | | | | | | | |

| | | | | | | | | | | | | | | | | | | | | | | | | | | | | | | | |
|-----------------------|---|-------|-------|-------|-------|-------|-------|-----|------|---|-----|------|---|-----|------|---|-----|-------|---|-----|------|---|-----|------|---|-----|------|---|-----|-------|---|
| <p>20 Skud</p> | <table style="width:100%; border-collapse: collapse;"> <tr><td style="width:5%;">11:</td><td style="width:15%;">*10.6</td><td style="width:10%; text-align: center;">↓</td></tr> <tr><td>12:</td><td>*10.6</td><td style="text-align: center;">↑</td></tr> <tr><td>13:</td><td>10.1</td><td style="text-align: center;">↓</td></tr> <tr><td>14:</td><td>10.4</td><td style="text-align: center;">↘</td></tr> <tr><td>15:</td><td>10.1</td><td style="text-align: center;">←</td></tr> <tr><td>16:</td><td>*10.6</td><td style="text-align: center;">↗</td></tr> <tr><td>17:</td><td>10.4</td><td style="text-align: center;">←</td></tr> <tr><td>18:</td><td>10.5</td><td style="text-align: center;">↘</td></tr> <tr><td>19:</td><td>10.4</td><td style="text-align: center;">↘</td></tr> <tr><td>20:</td><td>*10.8</td><td style="text-align: center;">↗</td></tr> </table> | 11: | *10.6 | ↓ | 12: | *10.6 | ↑ | 13: | 10.1 | ↓ | 14: | 10.4 | ↘ | 15: | 10.1 | ← | 16: | *10.6 | ↗ | 17: | 10.4 | ← | 18: | 10.5 | ↘ | 19: | 10.4 | ↘ | 20: | *10.8 | ↗ |
| 11: | *10.6 | ↓ | | | | | | | | | | | | | | | | | | | | | | | | | | | | | |
| 12: | *10.6 | ↑ | | | | | | | | | | | | | | | | | | | | | | | | | | | | | |
| 13: | 10.1 | ↓ | | | | | | | | | | | | | | | | | | | | | | | | | | | | | |
| 14: | 10.4 | ↘ | | | | | | | | | | | | | | | | | | | | | | | | | | | | | |
| 15: | 10.1 | ← | | | | | | | | | | | | | | | | | | | | | | | | | | | | | |
| 16: | *10.6 | ↗ | | | | | | | | | | | | | | | | | | | | | | | | | | | | | |
| 17: | 10.4 | ← | | | | | | | | | | | | | | | | | | | | | | | | | | | | | |
| 18: | 10.5 | ↘ | | | | | | | | | | | | | | | | | | | | | | | | | | | | | |
| 19: | 10.4 | ↘ | | | | | | | | | | | | | | | | | | | | | | | | | | | | | |
| 20: | *10.8 | ↗ | | | | | | | | | | | | | | | | | | | | | | | | | | | | | |
| | <table border="1" style="width:100%; border-collapse: collapse;"> <tr> <td style="width:5%;">Serie</td> <td style="width:15%;"></td> <td style="width:10%; text-align: right;">100.0</td> </tr> <tr> <td>Total</td> <td></td> <td style="text-align: right;">200.0</td> </tr> </table> | Serie | | 100.0 | Total | | 200.0 | | | | | | | | | | | | | | | | | | | | | | | | |
| Serie | | 100.0 | | | | | | | | | | | | | | | | | | | | | | | | | | | | | |
| Total | | 200.0 | | | | | | | | | | | | | | | | | | | | | | | | | | | | | |

| | | | | | | | | | | | | | | | | | | | | | | | | | | | | |
|---|--|-------|------|-------|-----|-----|---|----|-----|---|----|------|---|----|-----|---|----|-------|---|----|-------|---|----|-------|---|----|-------|---|
| <p>Prøve</p> | <table style="width:100%; border-collapse: collapse;"> <tr><td style="width:10%;">1:</td><td style="width:15%;">9.1</td><td style="width:10%; text-align: center;">↓</td></tr> <tr><td>2:</td><td>9.5</td><td style="text-align: center;">↓</td></tr> <tr><td>3:</td><td>9.9</td><td style="text-align: center;">→</td></tr> <tr><td>4:</td><td>10.2</td><td style="text-align: center;">→</td></tr> <tr><td>5:</td><td>9.8</td><td style="text-align: center;">→</td></tr> <tr><td>6:</td><td>*10.6</td><td style="text-align: center;">↙</td></tr> <tr><td>7:</td><td>*10.6</td><td style="text-align: center;">↙</td></tr> <tr><td>8:</td><td>*10.7</td><td style="text-align: center;">↙</td></tr> <tr><td>9:</td><td>*10.8</td><td style="text-align: center;">↙</td></tr> </table> | 1: | 9.1 | ↓ | 2: | 9.5 | ↓ | 3: | 9.9 | → | 4: | 10.2 | → | 5: | 9.8 | → | 6: | *10.6 | ↙ | 7: | *10.6 | ↙ | 8: | *10.7 | ↙ | 9: | *10.8 | ↙ |
| 1: | 9.1 | ↓ | | | | | | | | | | | | | | | | | | | | | | | | | | |
| 2: | 9.5 | ↓ | | | | | | | | | | | | | | | | | | | | | | | | | | |
| 3: | 9.9 | → | | | | | | | | | | | | | | | | | | | | | | | | | | |
| 4: | 10.2 | → | | | | | | | | | | | | | | | | | | | | | | | | | | |
| 5: | 9.8 | → | | | | | | | | | | | | | | | | | | | | | | | | | | |
| 6: | *10.6 | ↙ | | | | | | | | | | | | | | | | | | | | | | | | | | |
| 7: | *10.6 | ↙ | | | | | | | | | | | | | | | | | | | | | | | | | | |
| 8: | *10.7 | ↙ | | | | | | | | | | | | | | | | | | | | | | | | | | |
| 9: | *10.8 | ↙ | | | | | | | | | | | | | | | | | | | | | | | | | | |
| <table style="width:100%; border-collapse: collapse;"> <tr> <td style="width:90%;">Serie</td> <td style="text-align: right;">86.0</td> </tr> <tr> <td>Total</td> <td style="text-align: right;">0.0</td> </tr> </table> | | Serie | 86.0 | Total | 0.0 | | | | | | | | | | | | | | | | | | | | | | | |
| Serie | 86.0 | | | | | | | | | | | | | | | | | | | | | | | | | | | |
| Total | 0.0 | | | | | | | | | | | | | | | | | | | | | | | | | | | |

| | | | | | | | | | | | | | | | | | | | | | | | | | | | | | | | |
|--|---|-------|-------|-------|-------|------|---|----|------|---|----|-------|---|----|------|---|----|-------|---|----|-------|---|----|------|---|----|------|---|-----|------|---|
| <p>20 Skud</p> | <table style="width:100%; border-collapse: collapse;"> <tr><td style="width:10%;">1:</td><td style="width:15%;">*10.7</td><td style="width:10%; text-align: center;">←</td></tr> <tr><td>2:</td><td>10.1</td><td style="text-align: center;">↙</td></tr> <tr><td>3:</td><td>10.2</td><td style="text-align: center;">→</td></tr> <tr><td>4:</td><td>*10.8</td><td style="text-align: center;">←</td></tr> <tr><td>5:</td><td>10.1</td><td style="text-align: center;">←</td></tr> <tr><td>6:</td><td>*10.7</td><td style="text-align: center;">↖</td></tr> <tr><td>7:</td><td>*10.5</td><td style="text-align: center;">→</td></tr> <tr><td>8:</td><td>10.0</td><td style="text-align: center;">↘</td></tr> <tr><td>9:</td><td>10.0</td><td style="text-align: center;">↗</td></tr> <tr><td>10:</td><td>10.5</td><td style="text-align: center;">←</td></tr> </table> | 1: | *10.7 | ← | 2: | 10.1 | ↙ | 3: | 10.2 | → | 4: | *10.8 | ← | 5: | 10.1 | ← | 6: | *10.7 | ↖ | 7: | *10.5 | → | 8: | 10.0 | ↘ | 9: | 10.0 | ↗ | 10: | 10.5 | ← |
| 1: | *10.7 | ← | | | | | | | | | | | | | | | | | | | | | | | | | | | | | |
| 2: | 10.1 | ↙ | | | | | | | | | | | | | | | | | | | | | | | | | | | | | |
| 3: | 10.2 | → | | | | | | | | | | | | | | | | | | | | | | | | | | | | | |
| 4: | *10.8 | ← | | | | | | | | | | | | | | | | | | | | | | | | | | | | | |
| 5: | 10.1 | ← | | | | | | | | | | | | | | | | | | | | | | | | | | | | | |
| 6: | *10.7 | ↖ | | | | | | | | | | | | | | | | | | | | | | | | | | | | | |
| 7: | *10.5 | → | | | | | | | | | | | | | | | | | | | | | | | | | | | | | |
| 8: | 10.0 | ↘ | | | | | | | | | | | | | | | | | | | | | | | | | | | | | |
| 9: | 10.0 | ↗ | | | | | | | | | | | | | | | | | | | | | | | | | | | | | |
| 10: | 10.5 | ← | | | | | | | | | | | | | | | | | | | | | | | | | | | | | |
| <table style="width:100%; border-collapse: collapse;"> <tr> <td style="width:90%;">Serie</td> <td style="text-align: right;">100.0</td> </tr> <tr> <td>Total</td> <td style="text-align: right;">100.0</td> </tr> </table> | | Serie | 100.0 | Total | 100.0 | | | | | | | | | | | | | | | | | | | | | | | | | | |
| Serie | 100.0 | | | | | | | | | | | | | | | | | | | | | | | | | | | | | | |
| Total | 100.0 | | | | | | | | | | | | | | | | | | | | | | | | | | | | | | |

| | | | | | | | | | | | | | | | | | | | | | | | | | | | | | | | |
|---|--|-------|-------|-------|-------|-------|---|-----|-------|---|-----|-------|---|-----|------|---|-----|-------|---|-----|------|---|-----|-------|---|-----|-------|---|-----|-----|---|
| <p>20 Skud</p> | <table style="width:100%; border-collapse: collapse;"> <tr><td style="width:10%;">11:</td><td style="width:15%;">*10.8</td><td style="width:10%; text-align: center;">←</td></tr> <tr><td>12:</td><td>*10.8</td><td style="text-align: center;">↗</td></tr> <tr><td>13:</td><td>*10.5</td><td style="text-align: center;">↗</td></tr> <tr><td>14:</td><td>*10.7</td><td style="text-align: center;">↙</td></tr> <tr><td>15:</td><td>10.3</td><td style="text-align: center;">↙</td></tr> <tr><td>16:</td><td>*10.5</td><td style="text-align: center;">→</td></tr> <tr><td>17:</td><td>10.1</td><td style="text-align: center;">↘</td></tr> <tr><td>18:</td><td>*10.7</td><td style="text-align: center;">→</td></tr> <tr><td>19:</td><td>*10.5</td><td style="text-align: center;">↗</td></tr> <tr><td>20:</td><td>9.9</td><td style="text-align: center;">→</td></tr> </table> | 11: | *10.8 | ← | 12: | *10.8 | ↗ | 13: | *10.5 | ↗ | 14: | *10.7 | ↙ | 15: | 10.3 | ↙ | 16: | *10.5 | → | 17: | 10.1 | ↘ | 18: | *10.7 | → | 19: | *10.5 | ↗ | 20: | 9.9 | → |
| 11: | *10.8 | ← | | | | | | | | | | | | | | | | | | | | | | | | | | | | | |
| 12: | *10.8 | ↗ | | | | | | | | | | | | | | | | | | | | | | | | | | | | | |
| 13: | *10.5 | ↗ | | | | | | | | | | | | | | | | | | | | | | | | | | | | | |
| 14: | *10.7 | ↙ | | | | | | | | | | | | | | | | | | | | | | | | | | | | | |
| 15: | 10.3 | ↙ | | | | | | | | | | | | | | | | | | | | | | | | | | | | | |
| 16: | *10.5 | → | | | | | | | | | | | | | | | | | | | | | | | | | | | | | |
| 17: | 10.1 | ↘ | | | | | | | | | | | | | | | | | | | | | | | | | | | | | |
| 18: | *10.7 | → | | | | | | | | | | | | | | | | | | | | | | | | | | | | | |
| 19: | *10.5 | ↗ | | | | | | | | | | | | | | | | | | | | | | | | | | | | | |
| 20: | 9.9 | → | | | | | | | | | | | | | | | | | | | | | | | | | | | | | |
| <table style="width:100%; border-collapse: collapse;"> <tr> <td style="width:90%;">Serie</td> <td style="text-align: right;">99.0</td> </tr> <tr> <td>Total</td> <td style="text-align: right;">199.0</td> </tr> </table> | | Serie | 99.0 | Total | 199.0 | | | | | | | | | | | | | | | | | | | | | | | | | | |
| Serie | 99.0 | | | | | | | | | | | | | | | | | | | | | | | | | | | | | | |
| Total | 199.0 | | | | | | | | | | | | | | | | | | | | | | | | | | | | | | |

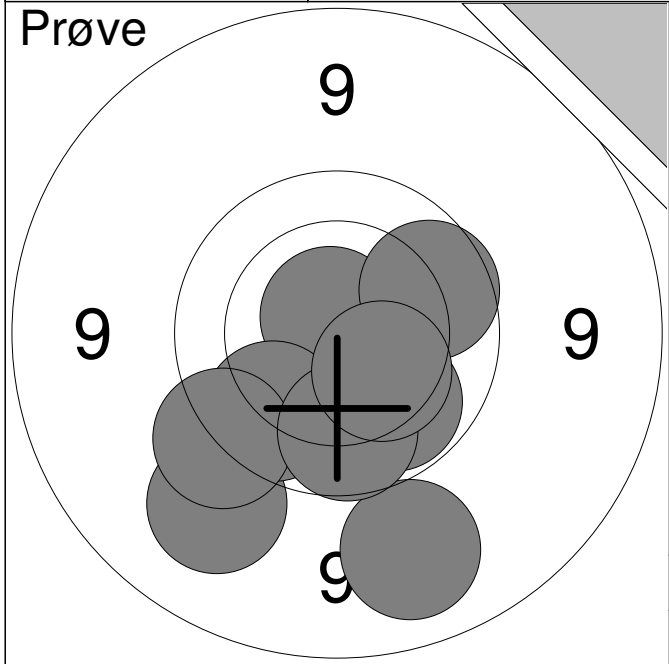

| | | |
|--------------|-------|-------------|
| 1: | 9.1 | ↓ |
| 2: | 9.2 | ↙ |
| 3: | *10.8 | ↑ |
| 4: | 9.9 | ↙ |
| 5: | 9.6 | ↙ |
| 6: | 10.0 | ↓ |
| 7: | 9.9 | ↗ |
| 8: | 9.9 | ↓ |
| 9: | 10.3 | ↘ |
| Serie | | 84.0 |
| Total | | 0.0 |

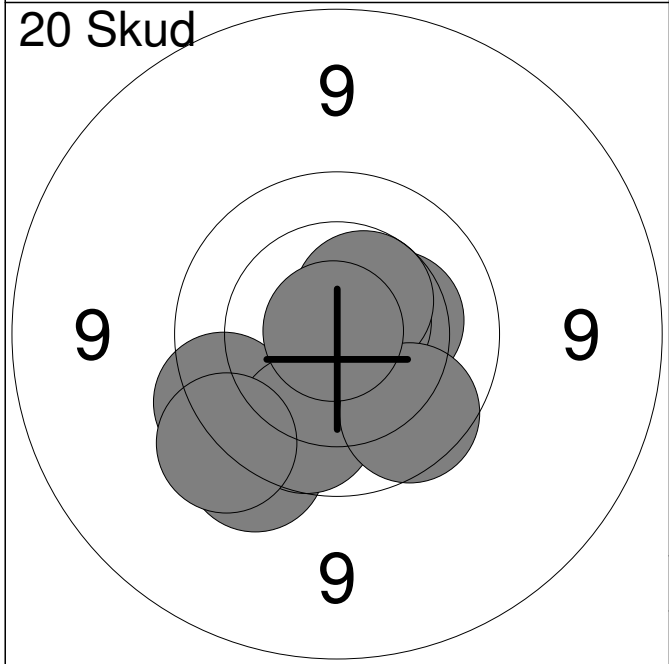

| | | |
|--------------|-------|-------------|
| 1: | *10.6 | → |
| 2: | 9.7 | ↙ |
| 3: | 10.3 | → |
| 4: | *10.7 | ↗ |
| 5: | *10.5 | ↗ |
| 6: | 9.6 | ↙ |
| 7: | 9.9 | ↙ |
| 8: | 9.6 | ↙ |
| 9: | 9.9 | ↘ |
| 10: | *10.9 | ↗ |
| Serie | | 95.0 |
| Total | | 95.0 |

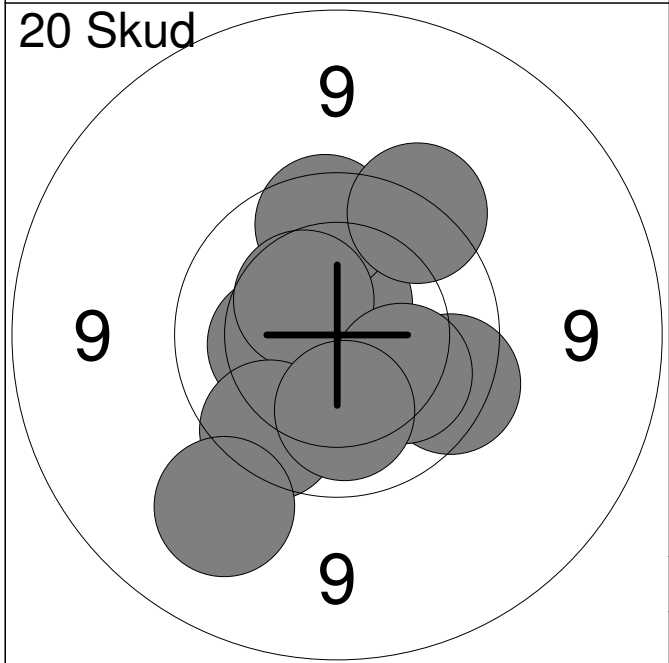

| | | |
|--------------|-------|--------------|
| 11: | *10.6 | ↑ |
| 12: | 10.3 | ← |
| 13: | 9.8 | ↑ |
| 14: | 9.6 | ↗ |
| 15: | 10.4 | ↗ |
| 16: | 9.8 | ↙ |
| 17: | 9.8 | ↘ |
| 18: | 10.1 | ↘ |
| 19: | 9.3 | ↙ |
| 20: | 10.1 | ↓ |
| Serie | | 95.0 |
| Total | | 190.0 |

| | | | | | | | | | | | | | | | | | | | | | | | | | |
|--|---|------|------|---|----|-----|---|----|------|---|----|-----|---|----|------|---|-------|--|--|-------|--|------|-------|--|-----|
| <p>Prøve</p>  | <table style="width:100%; border-collapse: collapse;"> <tr><td style="text-align: right;">1:</td><td style="text-align: right;">10.4</td><td style="text-align: right;">↘</td></tr> <tr><td style="text-align: right;">2:</td><td style="text-align: right;">9.9</td><td style="text-align: right;">←</td></tr> <tr><td style="text-align: right;">3:</td><td style="text-align: right;">10.2</td><td style="text-align: right;">↘</td></tr> <tr><td style="text-align: right;">4:</td><td style="text-align: right;">9.8</td><td style="text-align: right;">↑</td></tr> <tr><td style="text-align: right;">5:</td><td style="text-align: right;">10.4</td><td style="text-align: right;">↑</td></tr> <tr><td colspan="3"><hr/></td></tr> <tr><td style="text-align: right;">Serie</td><td></td><td style="text-align: right;">48.0</td></tr> <tr><td style="text-align: right;">Total</td><td></td><td style="text-align: right;">0.0</td></tr> </table> | 1: | 10.4 | ↘ | 2: | 9.9 | ← | 3: | 10.2 | ↘ | 4: | 9.8 | ↑ | 5: | 10.4 | ↑ | <hr/> | | | Serie | | 48.0 | Total | | 0.0 |
| 1: | 10.4 | ↘ | | | | | | | | | | | | | | | | | | | | | | | |
| 2: | 9.9 | ← | | | | | | | | | | | | | | | | | | | | | | | |
| 3: | 10.2 | ↘ | | | | | | | | | | | | | | | | | | | | | | | |
| 4: | 9.8 | ↑ | | | | | | | | | | | | | | | | | | | | | | | |
| 5: | 10.4 | ↑ | | | | | | | | | | | | | | | | | | | | | | | |
| <hr/> | | | | | | | | | | | | | | | | | | | | | | | | | |
| Serie | | 48.0 | | | | | | | | | | | | | | | | | | | | | | | |
| Total | | 0.0 | | | | | | | | | | | | | | | | | | | | | | | |

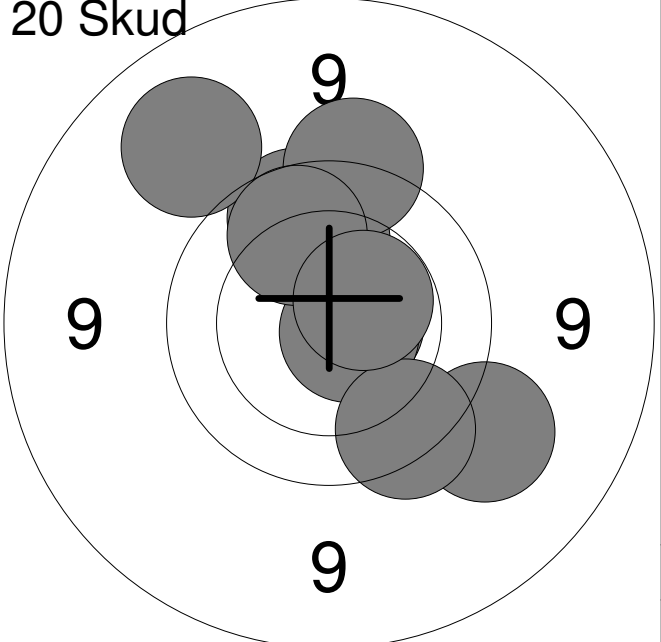
| | | | | | | | | | | | | | | | | | | | | | | | | | | | | | | | | | | | | | | | | |
|---|---|------|-----|---|----|-------|---|----|------|---|----|-----|---|----|-------|---|----|-----|---|----|-----|---|----|-----|---|----|-----|---|-----|-------|---|-------|--|--|-------|--|------|-------|--|------|
| <p>20 Skud</p>  | <table style="width:100%; border-collapse: collapse;"> <tr><td style="text-align: right;">1:</td><td style="text-align: right;">9.8</td><td style="text-align: right;">↑</td></tr> <tr><td style="text-align: right;">2:</td><td style="text-align: right;">*10.7</td><td style="text-align: right;">→</td></tr> <tr><td style="text-align: right;">3:</td><td style="text-align: right;">10.1</td><td style="text-align: right;">↑</td></tr> <tr><td style="text-align: right;">4:</td><td style="text-align: right;">9.6</td><td style="text-align: right;">↑</td></tr> <tr><td style="text-align: right;">5:</td><td style="text-align: right;">*10.7</td><td style="text-align: right;">↘</td></tr> <tr><td style="text-align: right;">6:</td><td style="text-align: right;">9.3</td><td style="text-align: right;">↘</td></tr> <tr><td style="text-align: right;">7:</td><td style="text-align: right;">9.1</td><td style="text-align: right;">↗</td></tr> <tr><td style="text-align: right;">8:</td><td style="text-align: right;">9.7</td><td style="text-align: right;">↘</td></tr> <tr><td style="text-align: right;">9:</td><td style="text-align: right;">9.9</td><td style="text-align: right;">↑</td></tr> <tr><td style="text-align: right;">10:</td><td style="text-align: right;">*10.5</td><td style="text-align: right;">↗</td></tr> <tr><td colspan="3"><hr/></td></tr> <tr><td style="text-align: right;">Serie</td><td></td><td style="text-align: right;">94.0</td></tr> <tr><td style="text-align: right;">Total</td><td></td><td style="text-align: right;">94.0</td></tr> </table> | 1: | 9.8 | ↑ | 2: | *10.7 | → | 3: | 10.1 | ↑ | 4: | 9.6 | ↑ | 5: | *10.7 | ↘ | 6: | 9.3 | ↘ | 7: | 9.1 | ↗ | 8: | 9.7 | ↘ | 9: | 9.9 | ↑ | 10: | *10.5 | ↗ | <hr/> | | | Serie | | 94.0 | Total | | 94.0 |
| 1: | 9.8 | ↑ | | | | | | | | | | | | | | | | | | | | | | | | | | | | | | | | | | | | | | |
| 2: | *10.7 | → | | | | | | | | | | | | | | | | | | | | | | | | | | | | | | | | | | | | | | |
| 3: | 10.1 | ↑ | | | | | | | | | | | | | | | | | | | | | | | | | | | | | | | | | | | | | | |
| 4: | 9.6 | ↑ | | | | | | | | | | | | | | | | | | | | | | | | | | | | | | | | | | | | | | |
| 5: | *10.7 | ↘ | | | | | | | | | | | | | | | | | | | | | | | | | | | | | | | | | | | | | | |
| 6: | 9.3 | ↘ | | | | | | | | | | | | | | | | | | | | | | | | | | | | | | | | | | | | | | |
| 7: | 9.1 | ↗ | | | | | | | | | | | | | | | | | | | | | | | | | | | | | | | | | | | | | | |
| 8: | 9.7 | ↘ | | | | | | | | | | | | | | | | | | | | | | | | | | | | | | | | | | | | | | |
| 9: | 9.9 | ↑ | | | | | | | | | | | | | | | | | | | | | | | | | | | | | | | | | | | | | | |
| 10: | *10.5 | ↗ | | | | | | | | | | | | | | | | | | | | | | | | | | | | | | | | | | | | | | |
| <hr/> | | | | | | | | | | | | | | | | | | | | | | | | | | | | | | | | | | | | | | | | |
| Serie | | 94.0 | | | | | | | | | | | | | | | | | | | | | | | | | | | | | | | | | | | | | | |
| Total | | 94.0 | | | | | | | | | | | | | | | | | | | | | | | | | | | | | | | | | | | | | | |

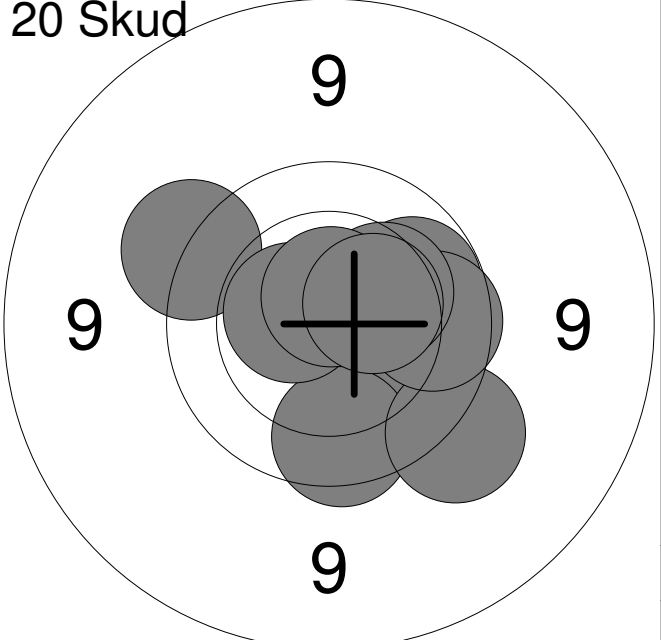
| | | | | | | | | | | | | | | | | | | | | | | | | | | | | | | | | | | | | | | | | |
|--|---|-------|-----|---|-----|-----|---|-----|-----|---|-----|-----|---|-----|------|---|-----|-------|---|-----|-----|---|-----|------|---|-----|-------|---|-----|------|---|-------|--|--|-------|--|------|-------|--|-------|
| <p>20 Skud</p>  | <table style="width:100%; border-collapse: collapse;"> <tr><td style="text-align: right;">11:</td><td style="text-align: right;">9.8</td><td style="text-align: right;">↘</td></tr> <tr><td style="text-align: right;">12:</td><td style="text-align: right;">9.8</td><td style="text-align: right;">↘</td></tr> <tr><td style="text-align: right;">13:</td><td style="text-align: right;">9.5</td><td style="text-align: right;">↘</td></tr> <tr><td style="text-align: right;">14:</td><td style="text-align: right;">9.6</td><td style="text-align: right;">↗</td></tr> <tr><td style="text-align: right;">15:</td><td style="text-align: right;">10.0</td><td style="text-align: right;">→</td></tr> <tr><td style="text-align: right;">16:</td><td style="text-align: right;">*10.6</td><td style="text-align: right;">←</td></tr> <tr><td style="text-align: right;">17:</td><td style="text-align: right;">9.9</td><td style="text-align: right;">→</td></tr> <tr><td style="text-align: right;">18:</td><td style="text-align: right;">10.3</td><td style="text-align: right;">↗</td></tr> <tr><td style="text-align: right;">19:</td><td style="text-align: right;">*10.7</td><td style="text-align: right;">↑</td></tr> <tr><td style="text-align: right;">20:</td><td style="text-align: right;">10.4</td><td style="text-align: right;">↗</td></tr> <tr><td colspan="3"><hr/></td></tr> <tr><td style="text-align: right;">Serie</td><td></td><td style="text-align: right;">95.0</td></tr> <tr><td style="text-align: right;">Total</td><td></td><td style="text-align: right;">189.0</td></tr> </table> | 11: | 9.8 | ↘ | 12: | 9.8 | ↘ | 13: | 9.5 | ↘ | 14: | 9.6 | ↗ | 15: | 10.0 | → | 16: | *10.6 | ← | 17: | 9.9 | → | 18: | 10.3 | ↗ | 19: | *10.7 | ↑ | 20: | 10.4 | ↗ | <hr/> | | | Serie | | 95.0 | Total | | 189.0 |
| 11: | 9.8 | ↘ | | | | | | | | | | | | | | | | | | | | | | | | | | | | | | | | | | | | | | |
| 12: | 9.8 | ↘ | | | | | | | | | | | | | | | | | | | | | | | | | | | | | | | | | | | | | | |
| 13: | 9.5 | ↘ | | | | | | | | | | | | | | | | | | | | | | | | | | | | | | | | | | | | | | |
| 14: | 9.6 | ↗ | | | | | | | | | | | | | | | | | | | | | | | | | | | | | | | | | | | | | | |
| 15: | 10.0 | → | | | | | | | | | | | | | | | | | | | | | | | | | | | | | | | | | | | | | | |
| 16: | *10.6 | ← | | | | | | | | | | | | | | | | | | | | | | | | | | | | | | | | | | | | | | |
| 17: | 9.9 | → | | | | | | | | | | | | | | | | | | | | | | | | | | | | | | | | | | | | | | |
| 18: | 10.3 | ↗ | | | | | | | | | | | | | | | | | | | | | | | | | | | | | | | | | | | | | | |
| 19: | *10.7 | ↑ | | | | | | | | | | | | | | | | | | | | | | | | | | | | | | | | | | | | | | |
| 20: | 10.4 | ↗ | | | | | | | | | | | | | | | | | | | | | | | | | | | | | | | | | | | | | | |
| <hr/> | | | | | | | | | | | | | | | | | | | | | | | | | | | | | | | | | | | | | | | | |
| Serie | | 95.0 | | | | | | | | | | | | | | | | | | | | | | | | | | | | | | | | | | | | | | |
| Total | | 189.0 | | | | | | | | | | | | | | | | | | | | | | | | | | | | | | | | | | | | | | |

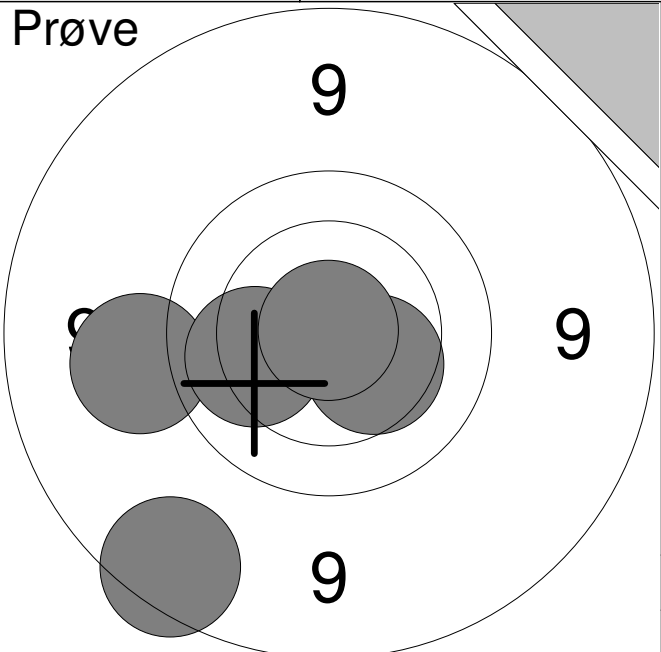
| | | | | | | | | | | | | | | | | | | | | |
|--|---|----|-----|---|----|-----|---|----|------|---|----|------|---|----|-------|---|-------|------|-------|-----|
| <p>Prøve</p>  | <table style="width:100%; border-collapse: collapse;"> <tr><td style="text-align: right;">1:</td><td style="text-align: right;">9.3</td><td style="text-align: right;">←</td></tr> <tr><td style="text-align: right;">2:</td><td style="text-align: right;">8.8</td><td style="text-align: right;">↘</td></tr> <tr><td style="text-align: right;">3:</td><td style="text-align: right;">10.1</td><td style="text-align: right;">←</td></tr> <tr><td style="text-align: right;">4:</td><td style="text-align: right;">10.4</td><td style="text-align: right;">↘</td></tr> <tr><td style="text-align: right;">5:</td><td style="text-align: right;">*10.9</td><td style="text-align: right;">↗</td></tr> </table> <table border="1" style="width:100%; border-collapse: collapse; margin-top: 5px;"> <tr> <td style="width:80%;">Serie</td> <td style="text-align: right;">47.0</td> </tr> <tr> <td>Total</td> <td style="text-align: right;">0.0</td> </tr> </table> | 1: | 9.3 | ← | 2: | 8.8 | ↘ | 3: | 10.1 | ← | 4: | 10.4 | ↘ | 5: | *10.9 | ↗ | Serie | 47.0 | Total | 0.0 |
| 1: | 9.3 | ← | | | | | | | | | | | | | | | | | | |
| 2: | 8.8 | ↘ | | | | | | | | | | | | | | | | | | |
| 3: | 10.1 | ← | | | | | | | | | | | | | | | | | | |
| 4: | 10.4 | ↘ | | | | | | | | | | | | | | | | | | |
| 5: | *10.9 | ↗ | | | | | | | | | | | | | | | | | | |
| Serie | 47.0 | | | | | | | | | | | | | | | | | | | |
| Total | 0.0 | | | | | | | | | | | | | | | | | | | |

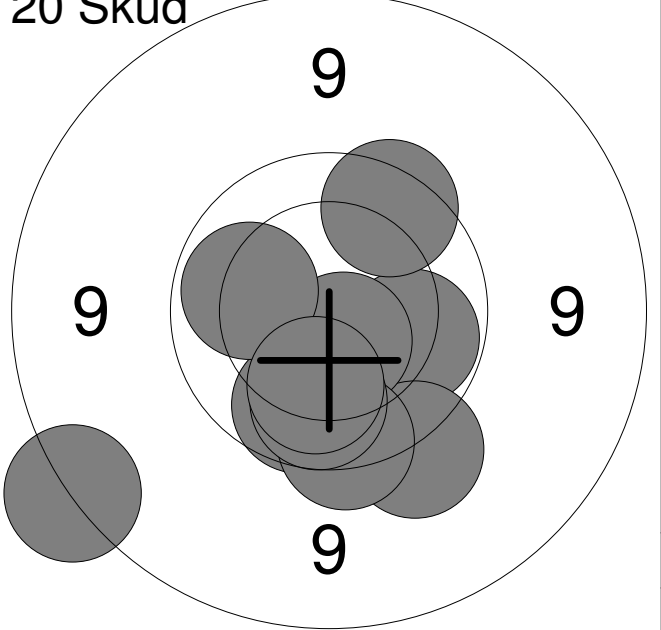
| | | | | | | | | | | | | | | | | | | | | | | | | | | | | | | | | | | | |
|---|---|----|-----|---|----|------|---|----|-----|---|----|-------|---|----|-----|---|----|-----|---|----|-----|---|----|------|---|----|------|---|-----|------|---|-------|------|-------|------|
| <p>20 Skud</p>  | <table style="width:100%; border-collapse: collapse;"> <tr><td style="text-align: right;">1:</td><td style="text-align: right;">9.9</td><td style="text-align: right;">↘</td></tr> <tr><td style="text-align: right;">2:</td><td style="text-align: right;">10.0</td><td style="text-align: right;">→</td></tr> <tr><td style="text-align: right;">3:</td><td style="text-align: right;">9.5</td><td style="text-align: right;">↘</td></tr> <tr><td style="text-align: right;">4:</td><td style="text-align: right;">*10.6</td><td style="text-align: right;">↘</td></tr> <tr><td style="text-align: right;">5:</td><td style="text-align: right;">9.7</td><td style="text-align: right;">↘</td></tr> <tr><td style="text-align: right;">6:</td><td style="text-align: right;">9.8</td><td style="text-align: right;">↗</td></tr> <tr><td style="text-align: right;">7:</td><td style="text-align: right;">8.7</td><td style="text-align: right;">←</td></tr> <tr><td style="text-align: right;">8:</td><td style="text-align: right;">10.0</td><td style="text-align: right;">←</td></tr> <tr><td style="text-align: right;">9:</td><td style="text-align: right;">10.0</td><td style="text-align: right;">↘</td></tr> <tr><td style="text-align: right;">10:</td><td style="text-align: right;">10.1</td><td style="text-align: right;">↘</td></tr> </table> <table border="1" style="width:100%; border-collapse: collapse; margin-top: 5px;"> <tr> <td style="width:80%;">Serie</td> <td style="text-align: right;">94.0</td> </tr> <tr> <td>Total</td> <td style="text-align: right;">94.0</td> </tr> </table> | 1: | 9.9 | ↘ | 2: | 10.0 | → | 3: | 9.5 | ↘ | 4: | *10.6 | ↘ | 5: | 9.7 | ↘ | 6: | 9.8 | ↗ | 7: | 8.7 | ← | 8: | 10.0 | ← | 9: | 10.0 | ↘ | 10: | 10.1 | ↘ | Serie | 94.0 | Total | 94.0 |
| 1: | 9.9 | ↘ | | | | | | | | | | | | | | | | | | | | | | | | | | | | | | | | | |
| 2: | 10.0 | → | | | | | | | | | | | | | | | | | | | | | | | | | | | | | | | | | |
| 3: | 9.5 | ↘ | | | | | | | | | | | | | | | | | | | | | | | | | | | | | | | | | |
| 4: | *10.6 | ↘ | | | | | | | | | | | | | | | | | | | | | | | | | | | | | | | | | |
| 5: | 9.7 | ↘ | | | | | | | | | | | | | | | | | | | | | | | | | | | | | | | | | |
| 6: | 9.8 | ↗ | | | | | | | | | | | | | | | | | | | | | | | | | | | | | | | | | |
| 7: | 8.7 | ← | | | | | | | | | | | | | | | | | | | | | | | | | | | | | | | | | |
| 8: | 10.0 | ← | | | | | | | | | | | | | | | | | | | | | | | | | | | | | | | | | |
| 9: | 10.0 | ↘ | | | | | | | | | | | | | | | | | | | | | | | | | | | | | | | | | |
| 10: | 10.1 | ↘ | | | | | | | | | | | | | | | | | | | | | | | | | | | | | | | | | |
| Serie | 94.0 | | | | | | | | | | | | | | | | | | | | | | | | | | | | | | | | | | |
| Total | 94.0 | | | | | | | | | | | | | | | | | | | | | | | | | | | | | | | | | | |

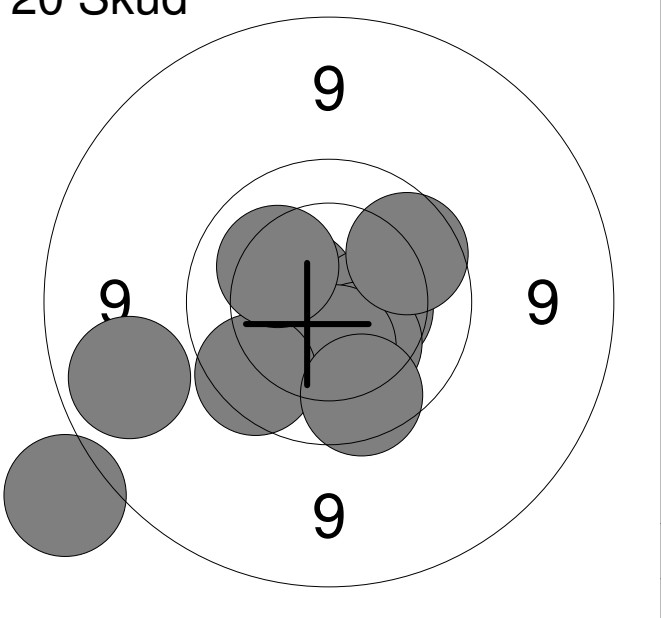
| | | | | | | | | | | | | | | | | | | | | | | | | | | | | | | | | | | | |
|--|---|-----|-----|---|-----|-------|---|-----|------|---|-----|------|---|-----|------|---|-----|-----|---|-----|-----|---|-----|-----|---|-----|-----|---|-----|------|---|-------|------|-------|-------|
| <p>20 Skud</p>  | <table style="width:100%; border-collapse: collapse;"> <tr><td style="text-align: right;">11:</td><td style="text-align: right;">9.0</td><td style="text-align: right;">←</td></tr> <tr><td style="text-align: right;">12:</td><td style="text-align: right;">*10.5</td><td style="text-align: right;">↗</td></tr> <tr><td style="text-align: right;">13:</td><td style="text-align: right;">10.4</td><td style="text-align: right;">→</td></tr> <tr><td style="text-align: right;">14:</td><td style="text-align: right;">10.3</td><td style="text-align: right;">↘</td></tr> <tr><td style="text-align: right;">15:</td><td style="text-align: right;">10.4</td><td style="text-align: right;">↘</td></tr> <tr><td style="text-align: right;">16:</td><td style="text-align: right;">9.8</td><td style="text-align: right;">↘</td></tr> <tr><td style="text-align: right;">17:</td><td style="text-align: right;">8.5</td><td style="text-align: right;">←</td></tr> <tr><td style="text-align: right;">18:</td><td style="text-align: right;">9.9</td><td style="text-align: right;">↗</td></tr> <tr><td style="text-align: right;">19:</td><td style="text-align: right;">9.8</td><td style="text-align: right;">↘</td></tr> <tr><td style="text-align: right;">20:</td><td style="text-align: right;">10.2</td><td style="text-align: right;">↗</td></tr> </table> <table border="1" style="width:100%; border-collapse: collapse; margin-top: 5px;"> <tr> <td style="width:80%;">Serie</td> <td style="text-align: right;">94.0</td> </tr> <tr> <td>Total</td> <td style="text-align: right;">188.0</td> </tr> </table> | 11: | 9.0 | ← | 12: | *10.5 | ↗ | 13: | 10.4 | → | 14: | 10.3 | ↘ | 15: | 10.4 | ↘ | 16: | 9.8 | ↘ | 17: | 8.5 | ← | 18: | 9.9 | ↗ | 19: | 9.8 | ↘ | 20: | 10.2 | ↗ | Serie | 94.0 | Total | 188.0 |
| 11: | 9.0 | ← | | | | | | | | | | | | | | | | | | | | | | | | | | | | | | | | | |
| 12: | *10.5 | ↗ | | | | | | | | | | | | | | | | | | | | | | | | | | | | | | | | | |
| 13: | 10.4 | → | | | | | | | | | | | | | | | | | | | | | | | | | | | | | | | | | |
| 14: | 10.3 | ↘ | | | | | | | | | | | | | | | | | | | | | | | | | | | | | | | | | |
| 15: | 10.4 | ↘ | | | | | | | | | | | | | | | | | | | | | | | | | | | | | | | | | |
| 16: | 9.8 | ↘ | | | | | | | | | | | | | | | | | | | | | | | | | | | | | | | | | |
| 17: | 8.5 | ← | | | | | | | | | | | | | | | | | | | | | | | | | | | | | | | | | |
| 18: | 9.9 | ↗ | | | | | | | | | | | | | | | | | | | | | | | | | | | | | | | | | |
| 19: | 9.8 | ↘ | | | | | | | | | | | | | | | | | | | | | | | | | | | | | | | | | |
| 20: | 10.2 | ↗ | | | | | | | | | | | | | | | | | | | | | | | | | | | | | | | | | |
| Serie | 94.0 | | | | | | | | | | | | | | | | | | | | | | | | | | | | | | | | | | |
| Total | 188.0 | | | | | | | | | | | | | | | | | | | | | | | | | | | | | | | | | | |

Hold
20Skive
8

Rasmus Klitgaard

Hjørring Skytteforening

J1

Prøve

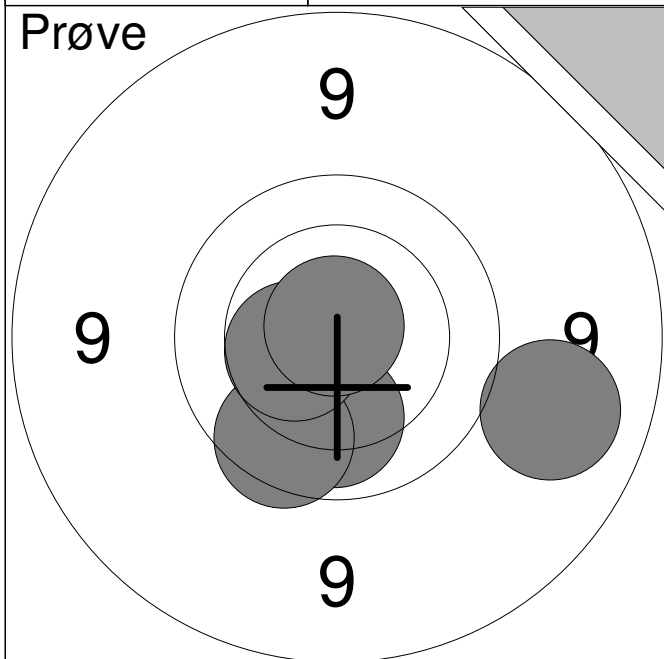

| | | |
|----|-------|---|
| 1: | 9.1 | → |
| 2: | 10.1 | ↓ |
| 3: | 9.8 | ↙ |
| 4: | 10.5 | ← |
| 5: | *10.8 | ↑ |

Serie 48.0

Total 0.0

20 Skud

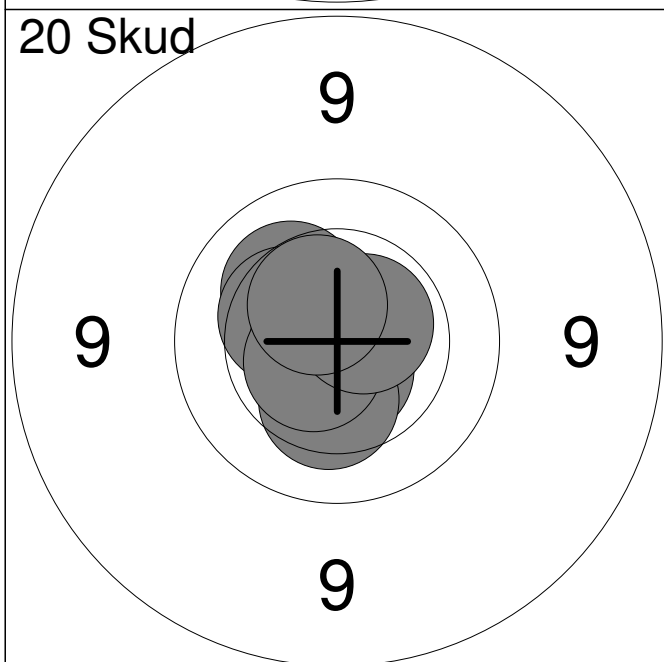

| | | |
|-----|-------|---|
| 1: | *10.8 | ↘ |
| 2: | 10.2 | ↗ |
| 3: | *10.6 | ↙ |
| 4: | 10.4 | ↗ |
| 5: | *10.6 | ↓ |
| 6: | *10.8 | ← |
| 7: | 10.3 | ↓ |
| 8: | *10.6 | ↙ |
| 9: | *10.6 | ↗ |
| 10: | *10.5 | ↗ |

Serie 100.0

Total 100.0

20 Skud

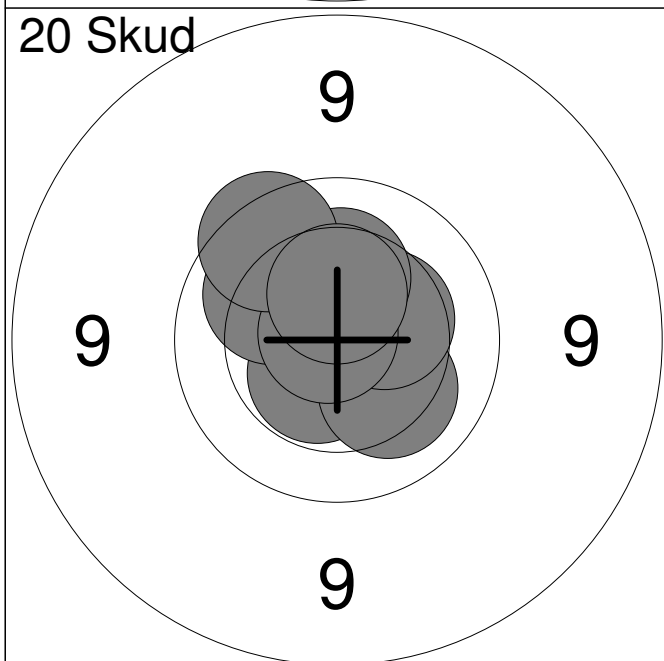

| | | |
|-----|-------|---|
| 11: | *10.7 | ↗ |
| 12: | *10.6 | ↗ |
| 13: | *10.5 | ↙ |
| 14: | 10.2 | ↘ |
| 15: | 10.4 | ↗ |
| 16: | 10.1 | ↗ |
| 17: | *10.8 | ↗ |
| 18: | 10.3 | ↑ |
| 19: | 9.8 | ↗ |
| 20: | 10.5 | ↑ |

Serie 99.0

Total 199.0

| | | | | | | | | | | | | | | | | |
|---|---|-------|-----|------|-------|-----|-----|----|-----|---|----|------|---|----|-------|---|
| <p>Prøve</p> | <table style="width:100%; border-collapse: collapse;"> <tr><td style="width:10%;">1:</td><td style="width:10%;">9.8</td><td style="width:10%; text-align: right;">↙</td></tr> <tr><td>2:</td><td>9.8</td><td style="text-align: right;">↙</td></tr> <tr><td>3:</td><td>9.8</td><td style="text-align: right;">↙</td></tr> <tr><td>4:</td><td>10.4</td><td style="text-align: right;">↗</td></tr> <tr><td>5:</td><td>*10.9</td><td style="text-align: right;">↖</td></tr> </table> | 1: | 9.8 | ↙ | 2: | 9.8 | ↙ | 3: | 9.8 | ↙ | 4: | 10.4 | ↗ | 5: | *10.9 | ↖ |
| 1: | 9.8 | ↙ | | | | | | | | | | | | | | |
| 2: | 9.8 | ↙ | | | | | | | | | | | | | | |
| 3: | 9.8 | ↙ | | | | | | | | | | | | | | |
| 4: | 10.4 | ↗ | | | | | | | | | | | | | | |
| 5: | *10.9 | ↖ | | | | | | | | | | | | | | |
| <table style="width:100%; border-collapse: collapse;"> <tr> <td style="width:10%;">Serie</td> <td style="width:10%;"></td> <td style="width:10%; text-align: right;">47.0</td> </tr> <tr> <td>Total</td> <td></td> <td style="text-align: right;">0.0</td> </tr> </table> | | Serie | | 47.0 | Total | | 0.0 | | | | | | | | | |
| Serie | | 47.0 | | | | | | | | | | | | | | |
| Total | | 0.0 | | | | | | | | | | | | | | |

| | | | | | | | | | | | | | | | | | | | | | | | | | | | | | | | |
|--|--|-------|------|------|-------|------|------|----|-----|---|----|------|---|----|------|---|----|------|---|----|------|---|----|------|---|----|------|---|-----|------|---|
| <p>20 Skud</p> | <table style="width:100%; border-collapse: collapse;"> <tr><td style="width:10%;">1:</td><td style="width:10%;">10.4</td><td style="width:10%; text-align: right;">←</td></tr> <tr><td>2:</td><td>10.0</td><td style="text-align: right;">↗</td></tr> <tr><td>3:</td><td>9.9</td><td style="text-align: right;">←</td></tr> <tr><td>4:</td><td>10.6</td><td style="text-align: right;">←</td></tr> <tr><td>5:</td><td>10.0</td><td style="text-align: right;">↗</td></tr> <tr><td>6:</td><td>10.6</td><td style="text-align: right;">↗</td></tr> <tr><td>7:</td><td>10.1</td><td style="text-align: right;">↗</td></tr> <tr><td>8:</td><td>10.5</td><td style="text-align: right;">↗</td></tr> <tr><td>9:</td><td>10.5</td><td style="text-align: right;">↗</td></tr> <tr><td>10:</td><td>10.1</td><td style="text-align: right;">←</td></tr> </table> | 1: | 10.4 | ← | 2: | 10.0 | ↗ | 3: | 9.9 | ← | 4: | 10.6 | ← | 5: | 10.0 | ↗ | 6: | 10.6 | ↗ | 7: | 10.1 | ↗ | 8: | 10.5 | ↗ | 9: | 10.5 | ↗ | 10: | 10.1 | ← |
| 1: | 10.4 | ← | | | | | | | | | | | | | | | | | | | | | | | | | | | | | |
| 2: | 10.0 | ↗ | | | | | | | | | | | | | | | | | | | | | | | | | | | | | |
| 3: | 9.9 | ← | | | | | | | | | | | | | | | | | | | | | | | | | | | | | |
| 4: | 10.6 | ← | | | | | | | | | | | | | | | | | | | | | | | | | | | | | |
| 5: | 10.0 | ↗ | | | | | | | | | | | | | | | | | | | | | | | | | | | | | |
| 6: | 10.6 | ↗ | | | | | | | | | | | | | | | | | | | | | | | | | | | | | |
| 7: | 10.1 | ↗ | | | | | | | | | | | | | | | | | | | | | | | | | | | | | |
| 8: | 10.5 | ↗ | | | | | | | | | | | | | | | | | | | | | | | | | | | | | |
| 9: | 10.5 | ↗ | | | | | | | | | | | | | | | | | | | | | | | | | | | | | |
| 10: | 10.1 | ← | | | | | | | | | | | | | | | | | | | | | | | | | | | | | |
| <table style="width:100%; border-collapse: collapse;"> <tr> <td style="width:10%;">Serie</td> <td style="width:10%;"></td> <td style="width:10%; text-align: right;">99.0</td> </tr> <tr> <td>Total</td> <td></td> <td style="text-align: right;">99.0</td> </tr> </table> | | Serie | | 99.0 | Total | | 99.0 | | | | | | | | | | | | | | | | | | | | | | | | |
| Serie | | 99.0 | | | | | | | | | | | | | | | | | | | | | | | | | | | | | |
| Total | | 99.0 | | | | | | | | | | | | | | | | | | | | | | | | | | | | | |

| | | | | | | | | | | | | | | | | | | | | | | | | | | | | | | | |
|---|---|-------|------|------|-------|------|-------|-----|------|---|-----|------|---|-----|-----|---|-----|------|---|-----|------|---|-----|-------|---|-----|------|---|-----|-----|---|
| <p>20 Skud</p> | <table style="width:100%; border-collapse: collapse;"> <tr><td style="width:10%;">11:</td><td style="width:10%;">10.4</td><td style="width:10%; text-align: right;">←</td></tr> <tr><td>12:</td><td>10.6</td><td style="text-align: right;">↑</td></tr> <tr><td>13:</td><td>10.5</td><td style="text-align: right;">↗</td></tr> <tr><td>14:</td><td>10.2</td><td style="text-align: right;">←</td></tr> <tr><td>15:</td><td>9.9</td><td style="text-align: right;">←</td></tr> <tr><td>16:</td><td>10.3</td><td style="text-align: right;">←</td></tr> <tr><td>17:</td><td>10.5</td><td style="text-align: right;">←</td></tr> <tr><td>18:</td><td>*10.7</td><td style="text-align: right;">↗</td></tr> <tr><td>19:</td><td>10.6</td><td style="text-align: right;">↙</td></tr> <tr><td>20:</td><td>9.6</td><td style="text-align: right;">←</td></tr> </table> | 11: | 10.4 | ← | 12: | 10.6 | ↑ | 13: | 10.5 | ↗ | 14: | 10.2 | ← | 15: | 9.9 | ← | 16: | 10.3 | ← | 17: | 10.5 | ← | 18: | *10.7 | ↗ | 19: | 10.6 | ↙ | 20: | 9.6 | ← |
| 11: | 10.4 | ← | | | | | | | | | | | | | | | | | | | | | | | | | | | | | |
| 12: | 10.6 | ↑ | | | | | | | | | | | | | | | | | | | | | | | | | | | | | |
| 13: | 10.5 | ↗ | | | | | | | | | | | | | | | | | | | | | | | | | | | | | |
| 14: | 10.2 | ← | | | | | | | | | | | | | | | | | | | | | | | | | | | | | |
| 15: | 9.9 | ← | | | | | | | | | | | | | | | | | | | | | | | | | | | | | |
| 16: | 10.3 | ← | | | | | | | | | | | | | | | | | | | | | | | | | | | | | |
| 17: | 10.5 | ← | | | | | | | | | | | | | | | | | | | | | | | | | | | | | |
| 18: | *10.7 | ↗ | | | | | | | | | | | | | | | | | | | | | | | | | | | | | |
| 19: | 10.6 | ↙ | | | | | | | | | | | | | | | | | | | | | | | | | | | | | |
| 20: | 9.6 | ← | | | | | | | | | | | | | | | | | | | | | | | | | | | | | |
| <table style="width:100%; border-collapse: collapse;"> <tr> <td style="width:10%;">Serie</td> <td style="width:10%;"></td> <td style="width:10%; text-align: right;">98.0</td> </tr> <tr> <td>Total</td> <td></td> <td style="text-align: right;">197.0</td> </tr> </table> | | Serie | | 98.0 | Total | | 197.0 | | | | | | | | | | | | | | | | | | | | | | | | |
| Serie | | 98.0 | | | | | | | | | | | | | | | | | | | | | | | | | | | | | |
| Total | | 197.0 | | | | | | | | | | | | | | | | | | | | | | | | | | | | | |

| | | | | | | | | | | | | | | | | | | | |
|---------------------|--|----|-------|---|----|-------|---|----|------|---|----|------|---|----|------|---|----|------|---|
| <p>Prøve</p> | <table style="width:100%; border-collapse: collapse;"> <tr><td style="width:10%;">1:</td><td style="width:10%;">*10.7</td><td style="width:10%; text-align: right;">→</td></tr> <tr><td>2:</td><td>*10.6</td><td style="text-align: right;">→</td></tr> <tr><td>3:</td><td>10.4</td><td style="text-align: right;">→</td></tr> <tr><td>4:</td><td>10.4</td><td style="text-align: right;">→</td></tr> <tr><td>5:</td><td>10.5</td><td style="text-align: right;">↗</td></tr> <tr><td>6:</td><td>10.6</td><td style="text-align: right;">↗</td></tr> </table> | 1: | *10.7 | → | 2: | *10.6 | → | 3: | 10.4 | → | 4: | 10.4 | → | 5: | 10.5 | ↗ | 6: | 10.6 | ↗ |
| 1: | *10.7 | → | | | | | | | | | | | | | | | | | |
| 2: | *10.6 | → | | | | | | | | | | | | | | | | | |
| 3: | 10.4 | → | | | | | | | | | | | | | | | | | |
| 4: | 10.4 | → | | | | | | | | | | | | | | | | | |
| 5: | 10.5 | ↗ | | | | | | | | | | | | | | | | | |
| 6: | 10.6 | ↗ | | | | | | | | | | | | | | | | | |

| | |
|-------|------|
| Serie | 60.0 |
| Total | 0.0 |

| | | | | | | | | | | | | | | | | | | | | | | | | | | | | | | | |
|-----------------------|--|----|------|---|----|------|---|----|------|---|----|------|---|----|------|---|----|------|---|----|------|---|----|-------|---|----|------|---|-----|------|---|
| <p>20 Skud</p> | <table style="width:100%; border-collapse: collapse;"> <tr><td style="width:10%;">1:</td><td style="width:10%;">10.3</td><td style="width:10%; text-align: right;">↑</td></tr> <tr><td>2:</td><td>10.3</td><td style="text-align: right;">↑</td></tr> <tr><td>3:</td><td>10.4</td><td style="text-align: right;">←</td></tr> <tr><td>4:</td><td>10.3</td><td style="text-align: right;">↑</td></tr> <tr><td>5:</td><td>10.1</td><td style="text-align: right;">↓</td></tr> <tr><td>6:</td><td>10.2</td><td style="text-align: right;">↗</td></tr> <tr><td>7:</td><td>10.5</td><td style="text-align: right;">↗</td></tr> <tr><td>8:</td><td>*10.6</td><td style="text-align: right;">↓</td></tr> <tr><td>9:</td><td>10.0</td><td style="text-align: right;">↓</td></tr> <tr><td>10:</td><td>10.3</td><td style="text-align: right;">↓</td></tr> </table> | 1: | 10.3 | ↑ | 2: | 10.3 | ↑ | 3: | 10.4 | ← | 4: | 10.3 | ↑ | 5: | 10.1 | ↓ | 6: | 10.2 | ↗ | 7: | 10.5 | ↗ | 8: | *10.6 | ↓ | 9: | 10.0 | ↓ | 10: | 10.3 | ↓ |
| 1: | 10.3 | ↑ | | | | | | | | | | | | | | | | | | | | | | | | | | | | | |
| 2: | 10.3 | ↑ | | | | | | | | | | | | | | | | | | | | | | | | | | | | | |
| 3: | 10.4 | ← | | | | | | | | | | | | | | | | | | | | | | | | | | | | | |
| 4: | 10.3 | ↑ | | | | | | | | | | | | | | | | | | | | | | | | | | | | | |
| 5: | 10.1 | ↓ | | | | | | | | | | | | | | | | | | | | | | | | | | | | | |
| 6: | 10.2 | ↗ | | | | | | | | | | | | | | | | | | | | | | | | | | | | | |
| 7: | 10.5 | ↗ | | | | | | | | | | | | | | | | | | | | | | | | | | | | | |
| 8: | *10.6 | ↓ | | | | | | | | | | | | | | | | | | | | | | | | | | | | | |
| 9: | 10.0 | ↓ | | | | | | | | | | | | | | | | | | | | | | | | | | | | | |
| 10: | 10.3 | ↓ | | | | | | | | | | | | | | | | | | | | | | | | | | | | | |

| | |
|-------|-------|
| Serie | 100.0 |
| Total | 100.0 |

| | | | | | | | | | | | | | | | | | | | | | | | | | | | | | | | |
|-----------------------|--|-----|------|---|-----|------|---|-----|-----|---|-----|------|---|-----|------|---|-----|------|---|-----|------|---|-----|------|---|-----|------|---|-----|-------|---|
| <p>20 Skud</p> | <table style="width:100%; border-collapse: collapse;"> <tr><td style="width:10%;">11:</td><td style="width:10%;">10.0</td><td style="width:10%; text-align: right;">↓</td></tr> <tr><td>12:</td><td>10.5</td><td style="text-align: right;">↓</td></tr> <tr><td>13:</td><td>9.9</td><td style="text-align: right;">↓</td></tr> <tr><td>14:</td><td>10.1</td><td style="text-align: right;">↓</td></tr> <tr><td>15:</td><td>10.5</td><td style="text-align: right;">↓</td></tr> <tr><td>16:</td><td>10.4</td><td style="text-align: right;">←</td></tr> <tr><td>17:</td><td>10.0</td><td style="text-align: right;">↓</td></tr> <tr><td>18:</td><td>10.4</td><td style="text-align: right;">↓</td></tr> <tr><td>19:</td><td>10.1</td><td style="text-align: right;">↓</td></tr> <tr><td>20:</td><td>*10.6</td><td style="text-align: right;">←</td></tr> </table> | 11: | 10.0 | ↓ | 12: | 10.5 | ↓ | 13: | 9.9 | ↓ | 14: | 10.1 | ↓ | 15: | 10.5 | ↓ | 16: | 10.4 | ← | 17: | 10.0 | ↓ | 18: | 10.4 | ↓ | 19: | 10.1 | ↓ | 20: | *10.6 | ← |
| 11: | 10.0 | ↓ | | | | | | | | | | | | | | | | | | | | | | | | | | | | | |
| 12: | 10.5 | ↓ | | | | | | | | | | | | | | | | | | | | | | | | | | | | | |
| 13: | 9.9 | ↓ | | | | | | | | | | | | | | | | | | | | | | | | | | | | | |
| 14: | 10.1 | ↓ | | | | | | | | | | | | | | | | | | | | | | | | | | | | | |
| 15: | 10.5 | ↓ | | | | | | | | | | | | | | | | | | | | | | | | | | | | | |
| 16: | 10.4 | ← | | | | | | | | | | | | | | | | | | | | | | | | | | | | | |
| 17: | 10.0 | ↓ | | | | | | | | | | | | | | | | | | | | | | | | | | | | | |
| 18: | 10.4 | ↓ | | | | | | | | | | | | | | | | | | | | | | | | | | | | | |
| 19: | 10.1 | ↓ | | | | | | | | | | | | | | | | | | | | | | | | | | | | | |
| 20: | *10.6 | ← | | | | | | | | | | | | | | | | | | | | | | | | | | | | | |

| | |
|-------|-------|
| Serie | 99.0 |
| Total | 199.0 |

| | | | | | | | | | | | | | | | | | | | | | | |
|---------------------|--|----|-------|---|----|-----|---|----|-----|---|----|------|---|----|------|---|----|-----|---|----|-------|---|
| <p>Prøve</p> | <table style="width:100%; border-collapse: collapse;"> <tr><td style="width:10%;">1:</td><td style="width:10%;">*10.8</td><td style="width:10%; text-align: right;">→</td></tr> <tr><td>2:</td><td>9.3</td><td style="text-align: right;">←</td></tr> <tr><td>3:</td><td>9.3</td><td style="text-align: right;">↓</td></tr> <tr><td>4:</td><td>10.1</td><td style="text-align: right;">↗</td></tr> <tr><td>5:</td><td>10.2</td><td style="text-align: right;">↗</td></tr> <tr><td>6:</td><td>8.8</td><td style="text-align: right;">↖</td></tr> <tr><td>7:</td><td>*10.7</td><td style="text-align: right;">←</td></tr> </table> | 1: | *10.8 | → | 2: | 9.3 | ← | 3: | 9.3 | ↓ | 4: | 10.1 | ↗ | 5: | 10.2 | ↗ | 6: | 8.8 | ↖ | 7: | *10.7 | ← |
| 1: | *10.8 | → | | | | | | | | | | | | | | | | | | | | |
| 2: | 9.3 | ← | | | | | | | | | | | | | | | | | | | | |
| 3: | 9.3 | ↓ | | | | | | | | | | | | | | | | | | | | |
| 4: | 10.1 | ↗ | | | | | | | | | | | | | | | | | | | | |
| 5: | 10.2 | ↗ | | | | | | | | | | | | | | | | | | | | |
| 6: | 8.8 | ↖ | | | | | | | | | | | | | | | | | | | | |
| 7: | *10.7 | ← | | | | | | | | | | | | | | | | | | | | |

| | |
|-------|------|
| Serie | 66.0 |
|-------|------|

| | |
|-------|-----|
| Total | 0.0 |
|-------|-----|

| | | | | | | | | | | | | | | | | | | | | | | | | | | | | | | | |
|-----------------------|---|----|-----|---|----|-----|---|----|-----|---|----|-----|---|----|------|---|----|------|---|----|-----|---|----|-----|---|----|-----|---|-----|-----|---|
| <p>20 Skud</p> | <table style="width:100%; border-collapse: collapse;"> <tr><td style="width:10%;">1:</td><td style="width:10%;">9.8</td><td style="width:10%; text-align: right;">↖</td></tr> <tr><td>2:</td><td>9.3</td><td style="text-align: right;">↗</td></tr> <tr><td>3:</td><td>9.7</td><td style="text-align: right;">↖</td></tr> <tr><td>4:</td><td>9.5</td><td style="text-align: right;">↘</td></tr> <tr><td>5:</td><td>10.2</td><td style="text-align: right;">←</td></tr> <tr><td>6:</td><td>10.0</td><td style="text-align: right;">↗</td></tr> <tr><td>7:</td><td>9.2</td><td style="text-align: right;">↓</td></tr> <tr><td>8:</td><td>9.8</td><td style="text-align: right;">↗</td></tr> <tr><td>9:</td><td>8.7</td><td style="text-align: right;">→</td></tr> <tr><td>10:</td><td>9.3</td><td style="text-align: right;">→</td></tr> </table> | 1: | 9.8 | ↖ | 2: | 9.3 | ↗ | 3: | 9.7 | ↖ | 4: | 9.5 | ↘ | 5: | 10.2 | ← | 6: | 10.0 | ↗ | 7: | 9.2 | ↓ | 8: | 9.8 | ↗ | 9: | 8.7 | → | 10: | 9.3 | → |
| 1: | 9.8 | ↖ | | | | | | | | | | | | | | | | | | | | | | | | | | | | | |
| 2: | 9.3 | ↗ | | | | | | | | | | | | | | | | | | | | | | | | | | | | | |
| 3: | 9.7 | ↖ | | | | | | | | | | | | | | | | | | | | | | | | | | | | | |
| 4: | 9.5 | ↘ | | | | | | | | | | | | | | | | | | | | | | | | | | | | | |
| 5: | 10.2 | ← | | | | | | | | | | | | | | | | | | | | | | | | | | | | | |
| 6: | 10.0 | ↗ | | | | | | | | | | | | | | | | | | | | | | | | | | | | | |
| 7: | 9.2 | ↓ | | | | | | | | | | | | | | | | | | | | | | | | | | | | | |
| 8: | 9.8 | ↗ | | | | | | | | | | | | | | | | | | | | | | | | | | | | | |
| 9: | 8.7 | → | | | | | | | | | | | | | | | | | | | | | | | | | | | | | |
| 10: | 9.3 | → | | | | | | | | | | | | | | | | | | | | | | | | | | | | | |

| | |
|-------|------|
| Serie | 91.0 |
|-------|------|

| | |
|-------|------|
| Total | 91.0 |
|-------|------|

| | | | | | | | | | | | | | | | | | | | | | | | | | | | | | | | |
|-----------------------|--|-----|------|---|-----|-----|---|-----|-----|---|-----|-------|---|-----|-----|---|-----|-----|---|-----|-----|---|-----|-----|---|-----|------|---|-----|-------|---|
| <p>20 Skud</p> | <table style="width:100%; border-collapse: collapse;"> <tr><td style="width:10%;">11:</td><td style="width:10%;">10.3</td><td style="width:10%; text-align: right;">↖</td></tr> <tr><td>12:</td><td>9.4</td><td style="text-align: right;">→</td></tr> <tr><td>13:</td><td>9.5</td><td style="text-align: right;">↗</td></tr> <tr><td>14:</td><td>*10.8</td><td style="text-align: right;">→</td></tr> <tr><td>15:</td><td>9.8</td><td style="text-align: right;">→</td></tr> <tr><td>16:</td><td>9.1</td><td style="text-align: right;">→</td></tr> <tr><td>17:</td><td>9.1</td><td style="text-align: right;">↗</td></tr> <tr><td>18:</td><td>9.6</td><td style="text-align: right;">↗</td></tr> <tr><td>19:</td><td>10.6</td><td style="text-align: right;">↗</td></tr> <tr><td>20:</td><td>*10.7</td><td style="text-align: right;">←</td></tr> </table> | 11: | 10.3 | ↖ | 12: | 9.4 | → | 13: | 9.5 | ↗ | 14: | *10.8 | → | 15: | 9.8 | → | 16: | 9.1 | → | 17: | 9.1 | ↗ | 18: | 9.6 | ↗ | 19: | 10.6 | ↗ | 20: | *10.7 | ← |
| 11: | 10.3 | ↖ | | | | | | | | | | | | | | | | | | | | | | | | | | | | | |
| 12: | 9.4 | → | | | | | | | | | | | | | | | | | | | | | | | | | | | | | |
| 13: | 9.5 | ↗ | | | | | | | | | | | | | | | | | | | | | | | | | | | | | |
| 14: | *10.8 | → | | | | | | | | | | | | | | | | | | | | | | | | | | | | | |
| 15: | 9.8 | → | | | | | | | | | | | | | | | | | | | | | | | | | | | | | |
| 16: | 9.1 | → | | | | | | | | | | | | | | | | | | | | | | | | | | | | | |
| 17: | 9.1 | ↗ | | | | | | | | | | | | | | | | | | | | | | | | | | | | | |
| 18: | 9.6 | ↗ | | | | | | | | | | | | | | | | | | | | | | | | | | | | | |
| 19: | 10.6 | ↗ | | | | | | | | | | | | | | | | | | | | | | | | | | | | | |
| 20: | *10.7 | ← | | | | | | | | | | | | | | | | | | | | | | | | | | | | | |

| | |
|-------|------|
| Serie | 94.0 |
|-------|------|

| | |
|-------|-------|
| Total | 185.0 |
|-------|-------|

Hold
20

Skive
12

Laust Frydkjær

Hjørring Skytteforening

BK3

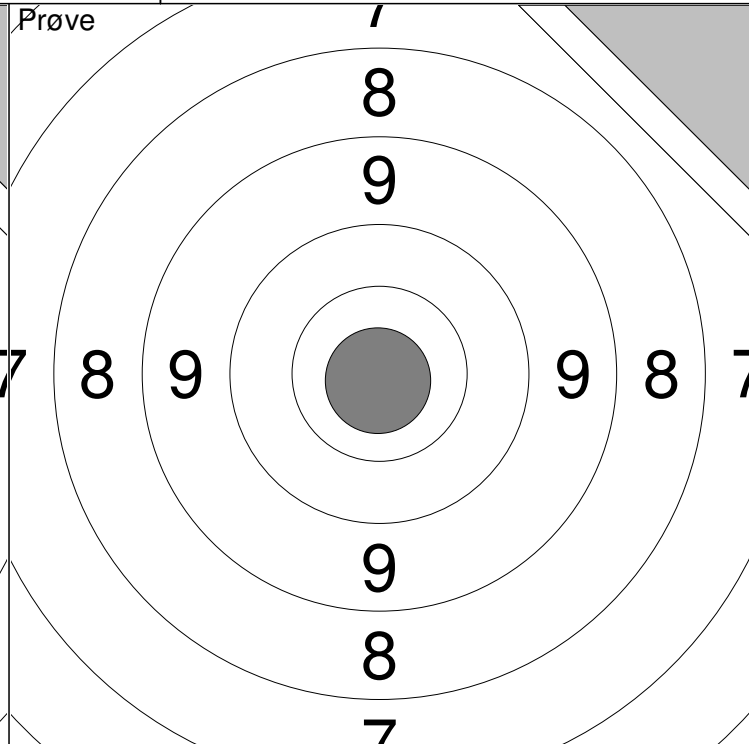
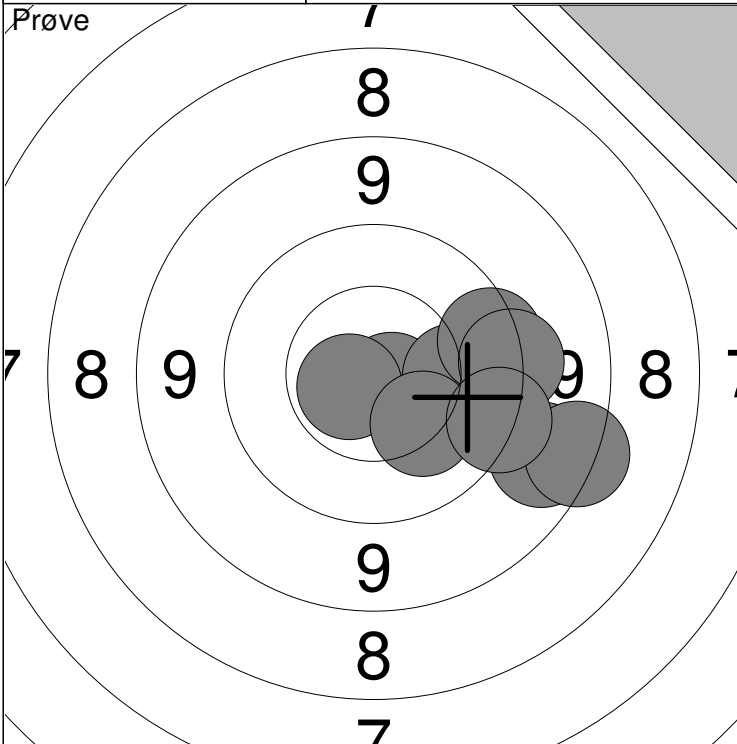

| | | |
|------------|------------|------------|
| 1: 10.1 → | 6: *10.7 ↙ | Serie 93.0 |
| 2: 8.9 ↘ | 7: 9.5 → | |
| 3: *10.7 ↘ | 8: 8.6 ↘ | Total 0.0 |
| 4: 10.1 → | 9: 10.2 ↘ | |
| 5: 9.7 → | 10: 9.5 ↘ | |

| | |
|-------------|------------|
| 11: *10.9 ↓ | Serie 10.0 |
| | Total 0.0 |

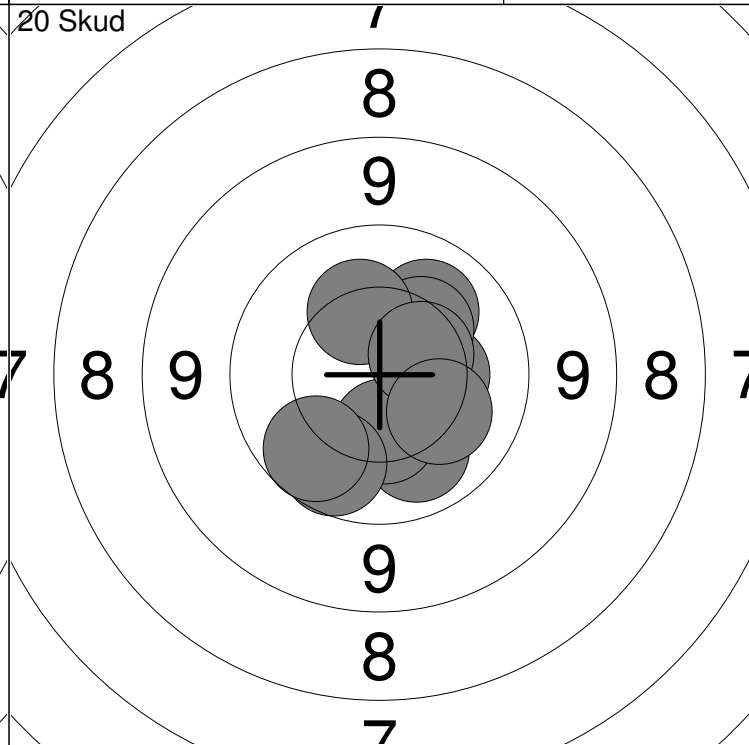
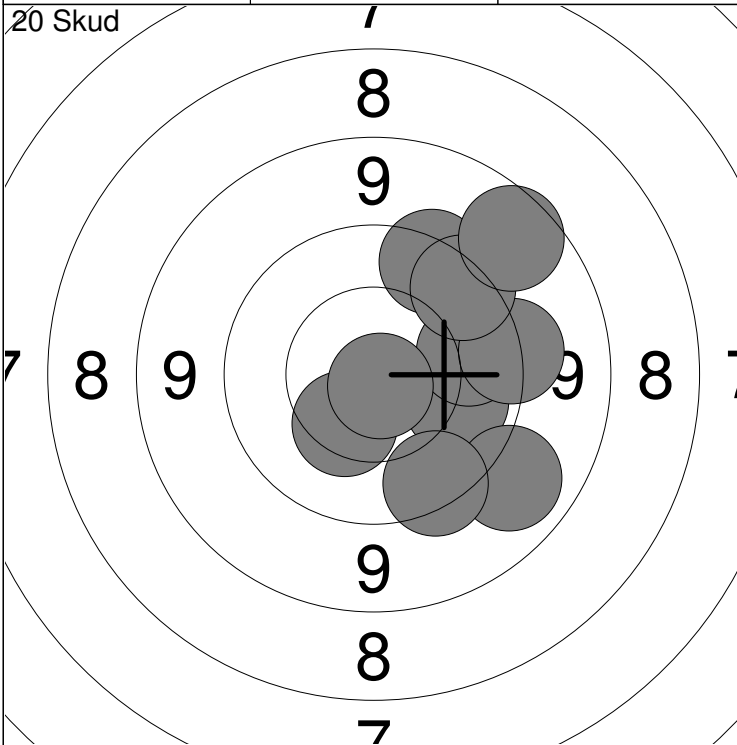

| | | |
|-----------|------------|------------|
| 1: 10.1 → | 6: 9.6 ↗ | Serie 92.0 |
| 2: 9.1 ↘ | 7: 9.6 ↗ | |
| 3: 9.9 → | 8: *10.8 ↘ | Total 92.0 |
| 4: 9.5 → | 9: 9.6 ↘ | |
| 5: 10.4 ↘ | 10: 8.9 ↗ | |

| | | |
|------------|------------|-------------|
| 11: 10.1 ↗ | 16: 9.9 ↘ | Serie 98.0 |
| 12: 10.4 → | 17: 10.3 ↗ | |
| 13: 10.1 ↘ | 18: 9.9 ↘ | Total 190.0 |
| 14: 10.4 ↘ | 19: 10.5 ↗ | |
| 15: 10.3 ↗ | 20: 10.2 ↘ | |

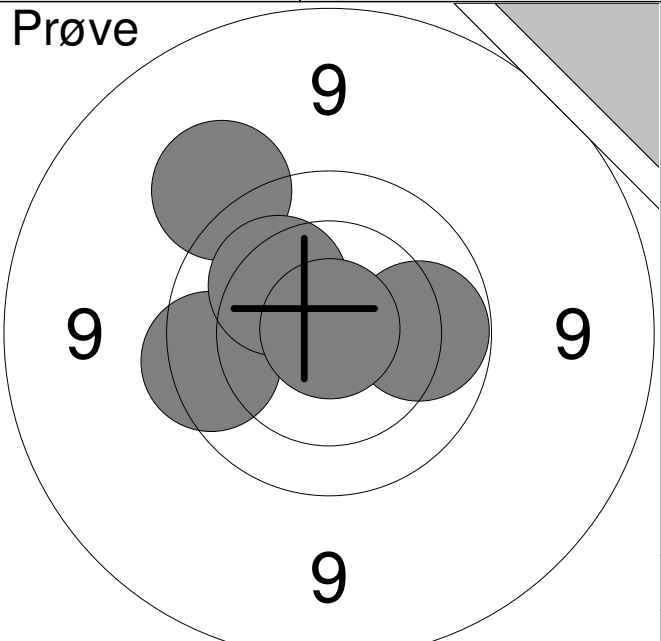
| | | | | | | | | | | | | | | | | |
|--|---|-------|------|-------|-----|-----|---|----|-----|---|----|------|---|----|-------|---|
| <p>Prøve</p>  | <table style="width:100%; border-collapse: collapse;"> <tr><td style="width:10%;">1:</td><td style="width:15%;">10.0</td><td style="width:10%; text-align: center;">→</td></tr> <tr><td>2:</td><td>9.4</td><td style="text-align: center;">↗</td></tr> <tr><td>3:</td><td>9.8</td><td style="text-align: center;">←</td></tr> <tr><td>4:</td><td>10.2</td><td style="text-align: center;">↗</td></tr> <tr><td>5:</td><td>*10.9</td><td style="text-align: center;">↑</td></tr> </table> | 1: | 10.0 | → | 2: | 9.4 | ↗ | 3: | 9.8 | ← | 4: | 10.2 | ↗ | 5: | *10.9 | ↑ |
| 1: | 10.0 | → | | | | | | | | | | | | | | |
| 2: | 9.4 | ↗ | | | | | | | | | | | | | | |
| 3: | 9.8 | ← | | | | | | | | | | | | | | |
| 4: | 10.2 | ↗ | | | | | | | | | | | | | | |
| 5: | *10.9 | ↑ | | | | | | | | | | | | | | |
| <table style="width:100%; border-collapse: collapse;"> <tr> <td style="width:45%;">Serie</td> <td style="width:55%; text-align: right;">48.0</td> </tr> <tr> <td>Total</td> <td style="text-align: right;">0.0</td> </tr> </table> | | Serie | 48.0 | Total | 0.0 | | | | | | | | | | | |
| Serie | 48.0 | | | | | | | | | | | | | | | |
| Total | 0.0 | | | | | | | | | | | | | | | |

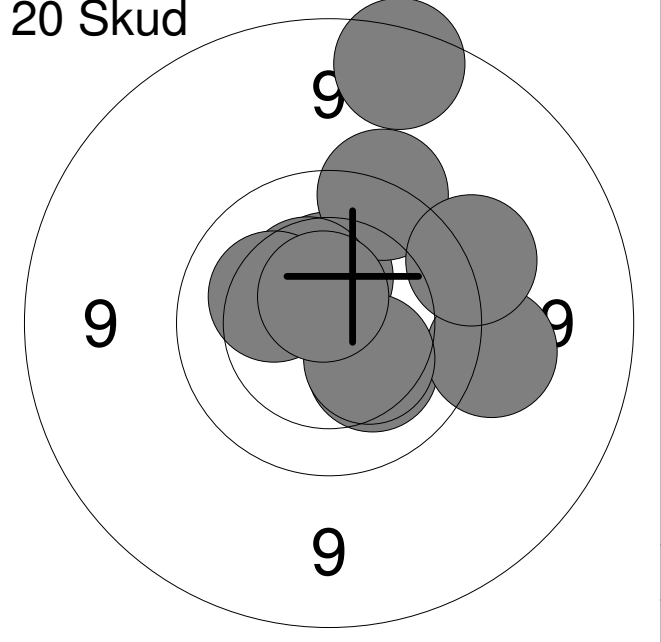
| | | | | | | | | | | | | | | | | | | | | | | | | | | | | | | | |
|---|--|-------|------|-------|------|------|---|----|-----|---|----|-----|---|----|------|---|----|------|---|----|-----|---|----|-----|---|----|------|---|-----|-------|---|
| <p>20 Skud</p>  | <table style="width:100%; border-collapse: collapse;"> <tr><td style="width:10%;">1:</td><td style="width:15%;">10.4</td><td style="width:10%; text-align: center;">↑</td></tr> <tr><td>2:</td><td>10.2</td><td style="text-align: center;">↘</td></tr> <tr><td>3:</td><td>9.6</td><td style="text-align: center;">↗</td></tr> <tr><td>4:</td><td>9.4</td><td style="text-align: center;">→</td></tr> <tr><td>5:</td><td>10.4</td><td style="text-align: center;">↗</td></tr> <tr><td>6:</td><td>10.3</td><td style="text-align: center;">↘</td></tr> <tr><td>7:</td><td>8.8</td><td style="text-align: center;">↑</td></tr> <tr><td>8:</td><td>9.5</td><td style="text-align: center;">↗</td></tr> <tr><td>9:</td><td>10.2</td><td style="text-align: center;">↖</td></tr> <tr><td>10:</td><td>*10.6</td><td style="text-align: center;">↑</td></tr> </table> | 1: | 10.4 | ↑ | 2: | 10.2 | ↘ | 3: | 9.6 | ↗ | 4: | 9.4 | → | 5: | 10.4 | ↗ | 6: | 10.3 | ↘ | 7: | 8.8 | ↑ | 8: | 9.5 | ↗ | 9: | 10.2 | ↖ | 10: | *10.6 | ↑ |
| 1: | 10.4 | ↑ | | | | | | | | | | | | | | | | | | | | | | | | | | | | | |
| 2: | 10.2 | ↘ | | | | | | | | | | | | | | | | | | | | | | | | | | | | | |
| 3: | 9.6 | ↗ | | | | | | | | | | | | | | | | | | | | | | | | | | | | | |
| 4: | 9.4 | → | | | | | | | | | | | | | | | | | | | | | | | | | | | | | |
| 5: | 10.4 | ↗ | | | | | | | | | | | | | | | | | | | | | | | | | | | | | |
| 6: | 10.3 | ↘ | | | | | | | | | | | | | | | | | | | | | | | | | | | | | |
| 7: | 8.8 | ↑ | | | | | | | | | | | | | | | | | | | | | | | | | | | | | |
| 8: | 9.5 | ↗ | | | | | | | | | | | | | | | | | | | | | | | | | | | | | |
| 9: | 10.2 | ↖ | | | | | | | | | | | | | | | | | | | | | | | | | | | | | |
| 10: | *10.6 | ↑ | | | | | | | | | | | | | | | | | | | | | | | | | | | | | |
| <table style="width:100%; border-collapse: collapse;"> <tr> <td style="width:45%;">Serie</td> <td style="width:55%; text-align: right;">95.0</td> </tr> <tr> <td>Total</td> <td style="text-align: right;">95.0</td> </tr> </table> | | Serie | 95.0 | Total | 95.0 | | | | | | | | | | | | | | | | | | | | | | | | | | |
| Serie | 95.0 | | | | | | | | | | | | | | | | | | | | | | | | | | | | | | |
| Total | 95.0 | | | | | | | | | | | | | | | | | | | | | | | | | | | | | | |

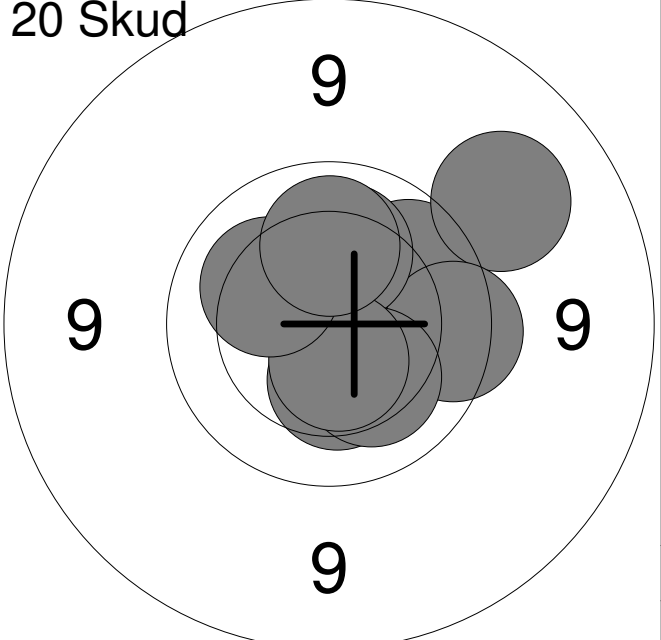
| | | | | | | | | | | | | | | | | | | | | | | | | | | | | | | | |
|--|--|-------|------|-------|-------|-----|---|-----|-----|---|-----|-----|---|-----|------|---|-----|------|---|-----|------|---|-----|-------|---|-----|------|---|-----|------|---|
| <p>20 Skud</p>  | <table style="width:100%; border-collapse: collapse;"> <tr><td style="width:10%;">11:</td><td style="width:15%;">10.5</td><td style="width:10%; text-align: center;">→</td></tr> <tr><td>12:</td><td>9.9</td><td style="text-align: center;">↗</td></tr> <tr><td>13:</td><td>9.2</td><td style="text-align: center;">↗</td></tr> <tr><td>14:</td><td>9.8</td><td style="text-align: center;">→</td></tr> <tr><td>15:</td><td>10.3</td><td style="text-align: center;">↓</td></tr> <tr><td>16:</td><td>10.2</td><td style="text-align: center;">↑</td></tr> <tr><td>17:</td><td>10.2</td><td style="text-align: center;">↘</td></tr> <tr><td>18:</td><td>*10.5</td><td style="text-align: center;">↓</td></tr> <tr><td>19:</td><td>10.2</td><td style="text-align: center;">↖</td></tr> <tr><td>20:</td><td>10.1</td><td style="text-align: center;">↑</td></tr> </table> | 11: | 10.5 | → | 12: | 9.9 | ↗ | 13: | 9.2 | ↗ | 14: | 9.8 | → | 15: | 10.3 | ↓ | 16: | 10.2 | ↑ | 17: | 10.2 | ↘ | 18: | *10.5 | ↓ | 19: | 10.2 | ↖ | 20: | 10.1 | ↑ |
| 11: | 10.5 | → | | | | | | | | | | | | | | | | | | | | | | | | | | | | | |
| 12: | 9.9 | ↗ | | | | | | | | | | | | | | | | | | | | | | | | | | | | | |
| 13: | 9.2 | ↗ | | | | | | | | | | | | | | | | | | | | | | | | | | | | | |
| 14: | 9.8 | → | | | | | | | | | | | | | | | | | | | | | | | | | | | | | |
| 15: | 10.3 | ↓ | | | | | | | | | | | | | | | | | | | | | | | | | | | | | |
| 16: | 10.2 | ↑ | | | | | | | | | | | | | | | | | | | | | | | | | | | | | |
| 17: | 10.2 | ↘ | | | | | | | | | | | | | | | | | | | | | | | | | | | | | |
| 18: | *10.5 | ↓ | | | | | | | | | | | | | | | | | | | | | | | | | | | | | |
| 19: | 10.2 | ↖ | | | | | | | | | | | | | | | | | | | | | | | | | | | | | |
| 20: | 10.1 | ↑ | | | | | | | | | | | | | | | | | | | | | | | | | | | | | |
| <table style="width:100%; border-collapse: collapse;"> <tr> <td style="width:45%;">Serie</td> <td style="width:55%; text-align: right;">97.0</td> </tr> <tr> <td>Total</td> <td style="text-align: right;">192.0</td> </tr> </table> | | Serie | 97.0 | Total | 192.0 | | | | | | | | | | | | | | | | | | | | | | | | | | |
| Serie | 97.0 | | | | | | | | | | | | | | | | | | | | | | | | | | | | | | |
| Total | 192.0 | | | | | | | | | | | | | | | | | | | | | | | | | | | | | | |

| | | | | | | | | | | | | | | | | | | | | | | | | | | |
|---------------------|--|----|-----|---|----|-----|---|----|-----|---|----|-----|---|----|-----|---|----|-------|---|----|------|---|-------|------|-------|-----|
| <p>Prøve</p> | <table style="width:100%; border-collapse: collapse;"> <tr><td style="text-align: right;">1:</td><td style="text-align: right;">9.7</td><td style="text-align: right;">←</td></tr> <tr><td style="text-align: right;">2:</td><td style="text-align: right;">9.4</td><td style="text-align: right;">→</td></tr> <tr><td style="text-align: right;">3:</td><td style="text-align: right;">9.0</td><td style="text-align: right;">↓</td></tr> <tr><td style="text-align: right;">4:</td><td style="text-align: right;">9.9</td><td style="text-align: right;">←</td></tr> <tr><td style="text-align: right;">5:</td><td style="text-align: right;">9.9</td><td style="text-align: right;">←</td></tr> <tr><td style="text-align: right;">6:</td><td style="text-align: right;">*10.5</td><td style="text-align: right;">↑</td></tr> <tr><td style="text-align: right;">7:</td><td style="text-align: right;">10.4</td><td style="text-align: right;">↑</td></tr> </table> <table border="1" style="width:100%; border-collapse: collapse; margin-top: 5px;"> <tr> <td style="width:80%;">Serie</td> <td style="text-align: right;">65.0</td> </tr> <tr> <td>Total</td> <td style="text-align: right;">0.0</td> </tr> </table> | 1: | 9.7 | ← | 2: | 9.4 | → | 3: | 9.0 | ↓ | 4: | 9.9 | ← | 5: | 9.9 | ← | 6: | *10.5 | ↑ | 7: | 10.4 | ↑ | Serie | 65.0 | Total | 0.0 |
| 1: | 9.7 | ← | | | | | | | | | | | | | | | | | | | | | | | | |
| 2: | 9.4 | → | | | | | | | | | | | | | | | | | | | | | | | | |
| 3: | 9.0 | ↓ | | | | | | | | | | | | | | | | | | | | | | | | |
| 4: | 9.9 | ← | | | | | | | | | | | | | | | | | | | | | | | | |
| 5: | 9.9 | ← | | | | | | | | | | | | | | | | | | | | | | | | |
| 6: | *10.5 | ↑ | | | | | | | | | | | | | | | | | | | | | | | | |
| 7: | 10.4 | ↑ | | | | | | | | | | | | | | | | | | | | | | | | |
| Serie | 65.0 | | | | | | | | | | | | | | | | | | | | | | | | | |
| Total | 0.0 | | | | | | | | | | | | | | | | | | | | | | | | | |

| | | | | | | | | | | | | | | | | | | | | | | | | | | | | | | | | | | | |
|-----------------------|--|----|------|---|----|-----|---|----|-----|---|----|-----|---|----|-----|---|----|-------|---|----|-------|---|----|-----|---|----|------|---|-----|------|---|-------|------|-------|------|
| <p>20 Skud</p> | <table style="width:100%; border-collapse: collapse;"> <tr><td style="text-align: right;">1:</td><td style="text-align: right;">10.0</td><td style="text-align: right;">↗</td></tr> <tr><td style="text-align: right;">2:</td><td style="text-align: right;">9.7</td><td style="text-align: right;">↑</td></tr> <tr><td style="text-align: right;">3:</td><td style="text-align: right;">9.9</td><td style="text-align: right;">↑</td></tr> <tr><td style="text-align: right;">4:</td><td style="text-align: right;">9.3</td><td style="text-align: right;">←</td></tr> <tr><td style="text-align: right;">5:</td><td style="text-align: right;">9.7</td><td style="text-align: right;">↗</td></tr> <tr><td style="text-align: right;">6:</td><td style="text-align: right;">*10.6</td><td style="text-align: right;">↓</td></tr> <tr><td style="text-align: right;">7:</td><td style="text-align: right;">*10.6</td><td style="text-align: right;">↗</td></tr> <tr><td style="text-align: right;">8:</td><td style="text-align: right;">9.8</td><td style="text-align: right;">↗</td></tr> <tr><td style="text-align: right;">9:</td><td style="text-align: right;">10.0</td><td style="text-align: right;">←</td></tr> <tr><td style="text-align: right;">10:</td><td style="text-align: right;">10.1</td><td style="text-align: right;">↓</td></tr> </table> <table border="1" style="width:100%; border-collapse: collapse; margin-top: 5px;"> <tr> <td style="width:80%;">Serie</td> <td style="text-align: right;">95.0</td> </tr> <tr> <td>Total</td> <td style="text-align: right;">95.0</td> </tr> </table> | 1: | 10.0 | ↗ | 2: | 9.7 | ↑ | 3: | 9.9 | ↑ | 4: | 9.3 | ← | 5: | 9.7 | ↗ | 6: | *10.6 | ↓ | 7: | *10.6 | ↗ | 8: | 9.8 | ↗ | 9: | 10.0 | ← | 10: | 10.1 | ↓ | Serie | 95.0 | Total | 95.0 |
| 1: | 10.0 | ↗ | | | | | | | | | | | | | | | | | | | | | | | | | | | | | | | | | |
| 2: | 9.7 | ↑ | | | | | | | | | | | | | | | | | | | | | | | | | | | | | | | | | |
| 3: | 9.9 | ↑ | | | | | | | | | | | | | | | | | | | | | | | | | | | | | | | | | |
| 4: | 9.3 | ← | | | | | | | | | | | | | | | | | | | | | | | | | | | | | | | | | |
| 5: | 9.7 | ↗ | | | | | | | | | | | | | | | | | | | | | | | | | | | | | | | | | |
| 6: | *10.6 | ↓ | | | | | | | | | | | | | | | | | | | | | | | | | | | | | | | | | |
| 7: | *10.6 | ↗ | | | | | | | | | | | | | | | | | | | | | | | | | | | | | | | | | |
| 8: | 9.8 | ↗ | | | | | | | | | | | | | | | | | | | | | | | | | | | | | | | | | |
| 9: | 10.0 | ← | | | | | | | | | | | | | | | | | | | | | | | | | | | | | | | | | |
| 10: | 10.1 | ↓ | | | | | | | | | | | | | | | | | | | | | | | | | | | | | | | | | |
| Serie | 95.0 | | | | | | | | | | | | | | | | | | | | | | | | | | | | | | | | | | |
| Total | 95.0 | | | | | | | | | | | | | | | | | | | | | | | | | | | | | | | | | | |

| | | | | | | | | | | | | | | | | | | | | | | | | | | | | | | | | | | | |
|-----------------------|--|-----|-----|---|-----|------|---|-----|-----|---|-----|------|---|-----|-----|---|-----|-----|---|-----|------|---|-----|------|---|-----|------|---|-----|-------|---|-------|------|-------|-------|
| <p>20 Skud</p> | <table style="width:100%; border-collapse: collapse;"> <tr><td style="text-align: right;">11:</td><td style="text-align: right;">9.5</td><td style="text-align: right;">↓</td></tr> <tr><td style="text-align: right;">12:</td><td style="text-align: right;">10.3</td><td style="text-align: right;">↗</td></tr> <tr><td style="text-align: right;">13:</td><td style="text-align: right;">9.9</td><td style="text-align: right;">↗</td></tr> <tr><td style="text-align: right;">14:</td><td style="text-align: right;">10.1</td><td style="text-align: right;">↗</td></tr> <tr><td style="text-align: right;">15:</td><td style="text-align: right;">9.9</td><td style="text-align: right;">↑</td></tr> <tr><td style="text-align: right;">16:</td><td style="text-align: right;">9.3</td><td style="text-align: right;">↗</td></tr> <tr><td style="text-align: right;">17:</td><td style="text-align: right;">10.1</td><td style="text-align: right;">←</td></tr> <tr><td style="text-align: right;">18:</td><td style="text-align: right;">10.0</td><td style="text-align: right;">↓</td></tr> <tr><td style="text-align: right;">19:</td><td style="text-align: right;">10.0</td><td style="text-align: right;">→</td></tr> <tr><td style="text-align: right;">20:</td><td style="text-align: right;">*10.5</td><td style="text-align: right;">↗</td></tr> </table> <table border="1" style="width:100%; border-collapse: collapse; margin-top: 5px;"> <tr> <td style="width:80%;">Serie</td> <td style="text-align: right;">96.0</td> </tr> <tr> <td>Total</td> <td style="text-align: right;">191.0</td> </tr> </table> | 11: | 9.5 | ↓ | 12: | 10.3 | ↗ | 13: | 9.9 | ↗ | 14: | 10.1 | ↗ | 15: | 9.9 | ↑ | 16: | 9.3 | ↗ | 17: | 10.1 | ← | 18: | 10.0 | ↓ | 19: | 10.0 | → | 20: | *10.5 | ↗ | Serie | 96.0 | Total | 191.0 |
| 11: | 9.5 | ↓ | | | | | | | | | | | | | | | | | | | | | | | | | | | | | | | | | |
| 12: | 10.3 | ↗ | | | | | | | | | | | | | | | | | | | | | | | | | | | | | | | | | |
| 13: | 9.9 | ↗ | | | | | | | | | | | | | | | | | | | | | | | | | | | | | | | | | |
| 14: | 10.1 | ↗ | | | | | | | | | | | | | | | | | | | | | | | | | | | | | | | | | |
| 15: | 9.9 | ↑ | | | | | | | | | | | | | | | | | | | | | | | | | | | | | | | | | |
| 16: | 9.3 | ↗ | | | | | | | | | | | | | | | | | | | | | | | | | | | | | | | | | |
| 17: | 10.1 | ← | | | | | | | | | | | | | | | | | | | | | | | | | | | | | | | | | |
| 18: | 10.0 | ↓ | | | | | | | | | | | | | | | | | | | | | | | | | | | | | | | | | |
| 19: | 10.0 | → | | | | | | | | | | | | | | | | | | | | | | | | | | | | | | | | | |
| 20: | *10.5 | ↗ | | | | | | | | | | | | | | | | | | | | | | | | | | | | | | | | | |
| Serie | 96.0 | | | | | | | | | | | | | | | | | | | | | | | | | | | | | | | | | | |
| Total | 191.0 | | | | | | | | | | | | | | | | | | | | | | | | | | | | | | | | | | |

| | | | | | | | | | | | | | | | | | | | | | | | | | | | | |
|---|---|-------|------|-------|-----|-----|---|----|-----|---|----|-----|---|----|------|---|----|-------|---|----|------|---|----|------|---|----|-------|---|
| <p>Prøve</p> | <table style="width:100%; border-collapse: collapse;"> <tr><td>1:</td><td>9.8</td><td>↙</td></tr> <tr><td>2:</td><td>9.4</td><td>↙</td></tr> <tr><td>3:</td><td>9.7</td><td>↙</td></tr> <tr><td>4:</td><td>9.8</td><td>↙</td></tr> <tr><td>5:</td><td>10.2</td><td>↙</td></tr> <tr><td>6:</td><td>*10.7</td><td>↙</td></tr> <tr><td>7:</td><td>10.4</td><td>↙</td></tr> <tr><td>8:</td><td>10.3</td><td>↑</td></tr> <tr><td>9:</td><td>*10.5</td><td>↙</td></tr> </table> | 1: | 9.8 | ↙ | 2: | 9.4 | ↙ | 3: | 9.7 | ↙ | 4: | 9.8 | ↙ | 5: | 10.2 | ↙ | 6: | *10.7 | ↙ | 7: | 10.4 | ↙ | 8: | 10.3 | ↑ | 9: | *10.5 | ↙ |
| 1: | 9.8 | ↙ | | | | | | | | | | | | | | | | | | | | | | | | | | |
| 2: | 9.4 | ↙ | | | | | | | | | | | | | | | | | | | | | | | | | | |
| 3: | 9.7 | ↙ | | | | | | | | | | | | | | | | | | | | | | | | | | |
| 4: | 9.8 | ↙ | | | | | | | | | | | | | | | | | | | | | | | | | | |
| 5: | 10.2 | ↙ | | | | | | | | | | | | | | | | | | | | | | | | | | |
| 6: | *10.7 | ↙ | | | | | | | | | | | | | | | | | | | | | | | | | | |
| 7: | 10.4 | ↙ | | | | | | | | | | | | | | | | | | | | | | | | | | |
| 8: | 10.3 | ↑ | | | | | | | | | | | | | | | | | | | | | | | | | | |
| 9: | *10.5 | ↙ | | | | | | | | | | | | | | | | | | | | | | | | | | |
| <table style="width:100%; border-collapse: collapse;"> <tr> <td style="width:80%;">Serie</td> <td style="text-align: right;">86.0</td> </tr> <tr> <td>Total</td> <td style="text-align: right;">0.0</td> </tr> </table> | | Serie | 86.0 | Total | 0.0 | | | | | | | | | | | | | | | | | | | | | | | |
| Serie | 86.0 | | | | | | | | | | | | | | | | | | | | | | | | | | | |
| Total | 0.0 | | | | | | | | | | | | | | | | | | | | | | | | | | | |

| | | | | | | | | | | | | | | | | | | | | | | | | | | | | | | | |
|--|---|-------|-------|-------|------|------|---|----|------|---|----|-------|---|----|------|---|----|-------|---|----|------|---|----|-----|---|----|------|---|-----|-------|---|
| <p>20 Skud</p> | <table style="width:100%; border-collapse: collapse;"> <tr><td>1:</td><td>*10.6</td><td>↙</td></tr> <tr><td>2:</td><td>10.3</td><td>→</td></tr> <tr><td>3:</td><td>10.3</td><td>↑</td></tr> <tr><td>4:</td><td>*10.8</td><td>↑</td></tr> <tr><td>5:</td><td>10.1</td><td>↙</td></tr> <tr><td>6:</td><td>*10.5</td><td>↘</td></tr> <tr><td>7:</td><td>10.4</td><td>↘</td></tr> <tr><td>8:</td><td>9.8</td><td>↙</td></tr> <tr><td>9:</td><td>10.3</td><td>→</td></tr> <tr><td>10:</td><td>*10.8</td><td>↗</td></tr> </table> | 1: | *10.6 | ↙ | 2: | 10.3 | → | 3: | 10.3 | ↑ | 4: | *10.8 | ↑ | 5: | 10.1 | ↙ | 6: | *10.5 | ↘ | 7: | 10.4 | ↘ | 8: | 9.8 | ↙ | 9: | 10.3 | → | 10: | *10.8 | ↗ |
| 1: | *10.6 | ↙ | | | | | | | | | | | | | | | | | | | | | | | | | | | | | |
| 2: | 10.3 | → | | | | | | | | | | | | | | | | | | | | | | | | | | | | | |
| 3: | 10.3 | ↑ | | | | | | | | | | | | | | | | | | | | | | | | | | | | | |
| 4: | *10.8 | ↑ | | | | | | | | | | | | | | | | | | | | | | | | | | | | | |
| 5: | 10.1 | ↙ | | | | | | | | | | | | | | | | | | | | | | | | | | | | | |
| 6: | *10.5 | ↘ | | | | | | | | | | | | | | | | | | | | | | | | | | | | | |
| 7: | 10.4 | ↘ | | | | | | | | | | | | | | | | | | | | | | | | | | | | | |
| 8: | 9.8 | ↙ | | | | | | | | | | | | | | | | | | | | | | | | | | | | | |
| 9: | 10.3 | → | | | | | | | | | | | | | | | | | | | | | | | | | | | | | |
| 10: | *10.8 | ↗ | | | | | | | | | | | | | | | | | | | | | | | | | | | | | |
| <table style="width:100%; border-collapse: collapse;"> <tr> <td style="width:80%;">Serie</td> <td style="text-align: right;">99.0</td> </tr> <tr> <td>Total</td> <td style="text-align: right;">99.0</td> </tr> </table> | | Serie | 99.0 | Total | 99.0 | | | | | | | | | | | | | | | | | | | | | | | | | | |
| Serie | 99.0 | | | | | | | | | | | | | | | | | | | | | | | | | | | | | | |
| Total | 99.0 | | | | | | | | | | | | | | | | | | | | | | | | | | | | | | |

| | | | | | | | | | | | | | | | | | | | | | | | | | | | | | | | |
|--|---|-------|-------|-------|-------|------|---|-----|-------|---|-----|-------|---|-----|------|---|-----|-------|---|-----|-------|---|-----|-------|---|-----|------|---|-----|-------|---|
| <p>20 Skud</p> | <table style="width:100%; border-collapse: collapse;"> <tr><td>11:</td><td>10.4</td><td>↘</td></tr> <tr><td>12:</td><td>10.3</td><td>↑</td></tr> <tr><td>13:</td><td>*10.6</td><td>↗</td></tr> <tr><td>14:</td><td>*10.9</td><td>↙</td></tr> <tr><td>15:</td><td>10.4</td><td>↑</td></tr> <tr><td>16:</td><td>*10.5</td><td>↙</td></tr> <tr><td>17:</td><td>*10.6</td><td>↙</td></tr> <tr><td>18:</td><td>*10.7</td><td>↑</td></tr> <tr><td>19:</td><td>10.3</td><td>↘</td></tr> <tr><td>20:</td><td>*10.8</td><td>↙</td></tr> </table> | 11: | 10.4 | ↘ | 12: | 10.3 | ↑ | 13: | *10.6 | ↗ | 14: | *10.9 | ↙ | 15: | 10.4 | ↑ | 16: | *10.5 | ↙ | 17: | *10.6 | ↙ | 18: | *10.7 | ↑ | 19: | 10.3 | ↘ | 20: | *10.8 | ↙ |
| 11: | 10.4 | ↘ | | | | | | | | | | | | | | | | | | | | | | | | | | | | | |
| 12: | 10.3 | ↑ | | | | | | | | | | | | | | | | | | | | | | | | | | | | | |
| 13: | *10.6 | ↗ | | | | | | | | | | | | | | | | | | | | | | | | | | | | | |
| 14: | *10.9 | ↙ | | | | | | | | | | | | | | | | | | | | | | | | | | | | | |
| 15: | 10.4 | ↑ | | | | | | | | | | | | | | | | | | | | | | | | | | | | | |
| 16: | *10.5 | ↙ | | | | | | | | | | | | | | | | | | | | | | | | | | | | | |
| 17: | *10.6 | ↙ | | | | | | | | | | | | | | | | | | | | | | | | | | | | | |
| 18: | *10.7 | ↑ | | | | | | | | | | | | | | | | | | | | | | | | | | | | | |
| 19: | 10.3 | ↘ | | | | | | | | | | | | | | | | | | | | | | | | | | | | | |
| 20: | *10.8 | ↙ | | | | | | | | | | | | | | | | | | | | | | | | | | | | | |
| <table style="width:100%; border-collapse: collapse;"> <tr> <td style="width:80%;">Serie</td> <td style="text-align: right;">100.0</td> </tr> <tr> <td>Total</td> <td style="text-align: right;">199.0</td> </tr> </table> | | Serie | 100.0 | Total | 199.0 | | | | | | | | | | | | | | | | | | | | | | | | | | |
| Serie | 100.0 | | | | | | | | | | | | | | | | | | | | | | | | | | | | | | |
| Total | 199.0 | | | | | | | | | | | | | | | | | | | | | | | | | | | | | | |

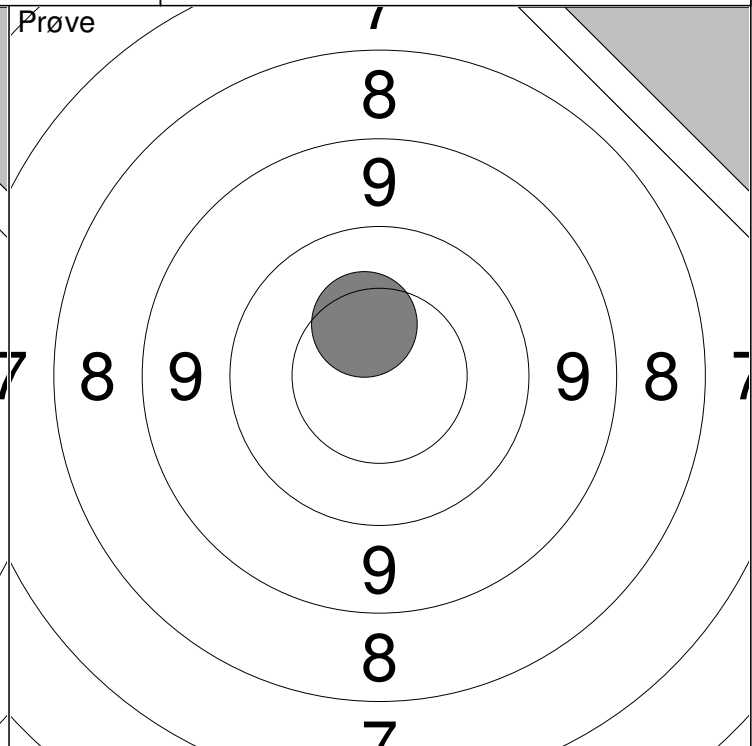
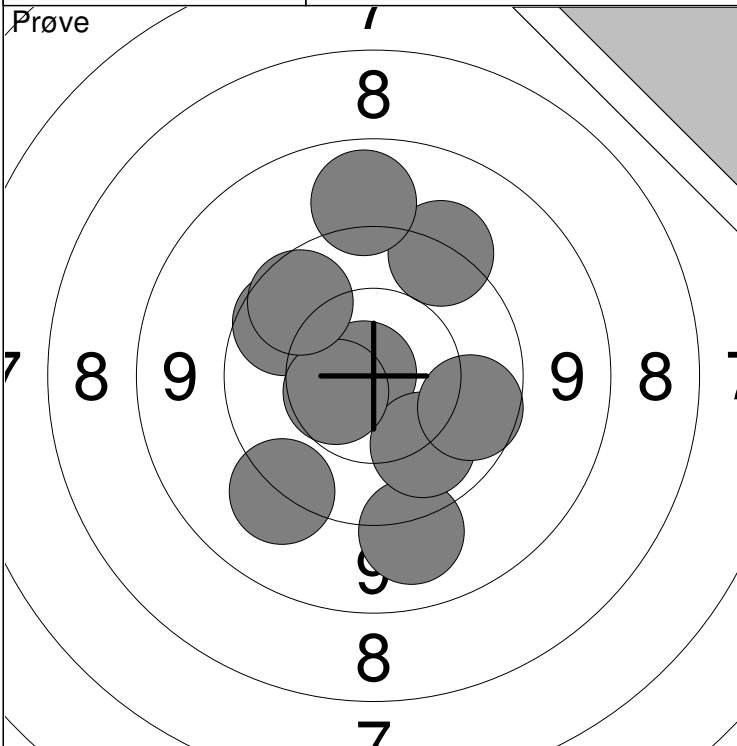

| | | |
|------------|-----------|------------|
| 1: 9.2 ↓ | 6: 10.1 ↓ | Serie 93.0 |
| 2: *10.8 ← | 7: 10.5 ← | |
| 3: 9.5 ↗ | 8: 9.9 ↗ | Total 0.0 |
| 4: 9.9 ↖ | 9: 9.4 ↓ | |
| 5: 9.1 ↑ | 10: 9.9 → | |

| | |
|------------|------------|
| 11: 10.4 ↗ | Serie 10.0 |
| | |
| | Total 0.0 |

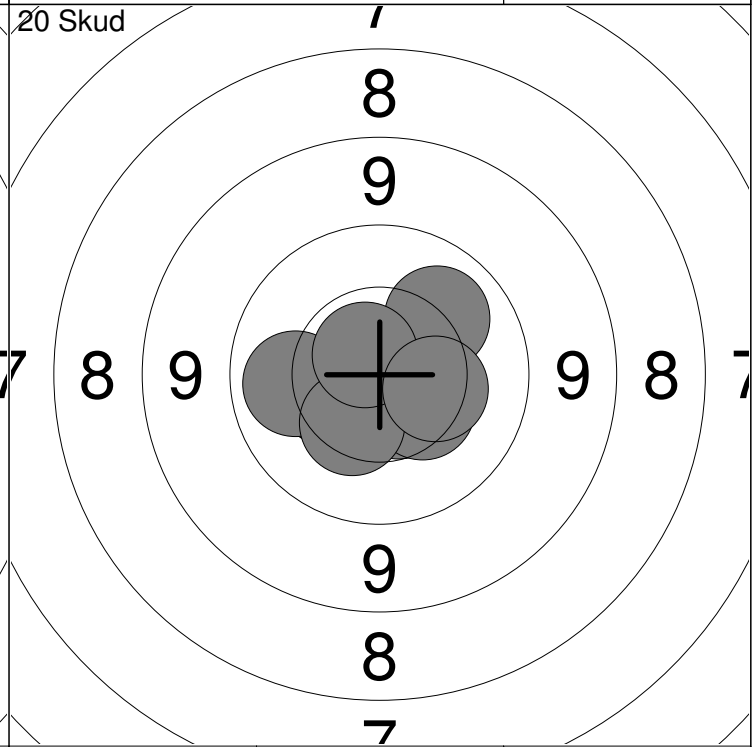
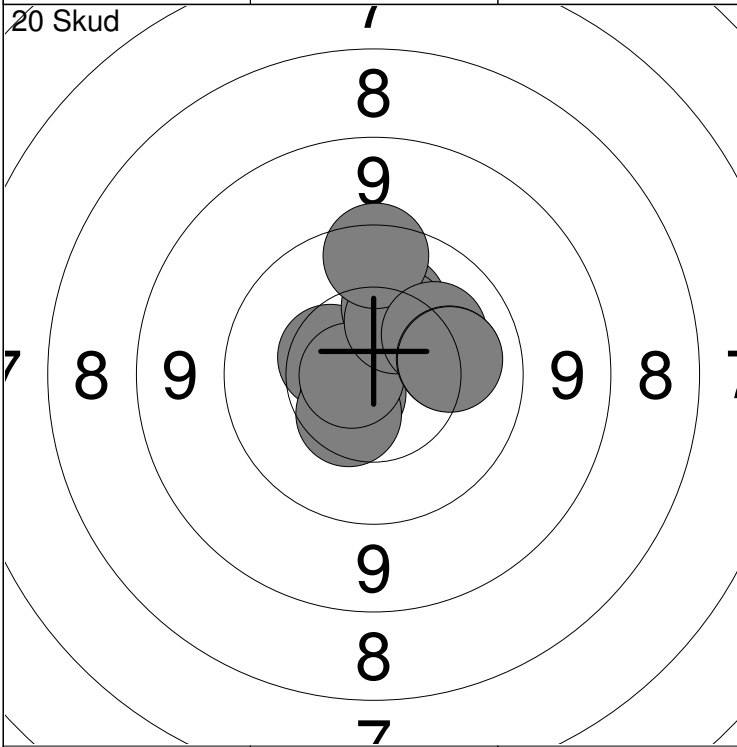

| | | |
|------------|------------|------------|
| 1: 10.5 ← | 6: 10.3 ↗ | Serie 99.0 |
| 2: 10.2 ↑ | 7: 9.7 ↑ | |
| 3: *10.7 ← | 8: 10.2 ↗ | Total 99.0 |
| 4: 10.5 ↓ | 9: 10.1 → | |
| 5: *10.7 ← | 10: 10.1 → | |

| | | |
|-------------|-------------|-------------|
| 11: 10.1 ↗ | 16: 10.4 ← | Serie 100.0 |
| 12: 10.6 ↓ | 17: 10.1 ← | |
| 13: 10.4 ↓ | 18: 10.4 ↓ | Total 199.0 |
| 14: 10.4 ← | 19: *10.7 ↗ | |
| 15: *10.7 ↓ | 20: 10.4 → | |

| | | | | | | | | | | | | | | | | | | | | | | | | | |
|---------------------|---|-------|-----|------|-------|-----|-----|----|-----|---|----|-----|---|----|-----|---|----|-----|---|----|------|---|----|-----|---|
| <p>Prøve</p> | <table style="width:100%; border-collapse: collapse;"> <tr><td style="width:10%;">1:</td><td style="width:15%;">8.0</td><td style="width:10%; text-align: center;">↓</td></tr> <tr><td>2:</td><td>8.7</td><td style="text-align: center;">↓</td></tr> <tr><td>3:</td><td>8.9</td><td style="text-align: center;">↓</td></tr> <tr><td>4:</td><td>8.8</td><td style="text-align: center;">↖</td></tr> <tr><td>5:</td><td>8.5</td><td style="text-align: center;">←</td></tr> <tr><td>6:</td><td>9.8</td><td style="text-align: center;">↓</td></tr> <tr><td>7:</td><td>10.3</td><td style="text-align: center;">↓</td></tr> <tr><td>8:</td><td>9.6</td><td style="text-align: center;">↓</td></tr> </table> | 1: | 8.0 | ↓ | 2: | 8.7 | ↓ | 3: | 8.9 | ↓ | 4: | 8.8 | ↖ | 5: | 8.5 | ← | 6: | 9.8 | ↓ | 7: | 10.3 | ↓ | 8: | 9.6 | ↓ |
| 1: | 8.0 | ↓ | | | | | | | | | | | | | | | | | | | | | | | |
| 2: | 8.7 | ↓ | | | | | | | | | | | | | | | | | | | | | | | |
| 3: | 8.9 | ↓ | | | | | | | | | | | | | | | | | | | | | | | |
| 4: | 8.8 | ↖ | | | | | | | | | | | | | | | | | | | | | | | |
| 5: | 8.5 | ← | | | | | | | | | | | | | | | | | | | | | | | |
| 6: | 9.8 | ↓ | | | | | | | | | | | | | | | | | | | | | | | |
| 7: | 10.3 | ↓ | | | | | | | | | | | | | | | | | | | | | | | |
| 8: | 9.6 | ↓ | | | | | | | | | | | | | | | | | | | | | | | |
| | <table style="width:100%; border-collapse: collapse;"> <tr> <td style="width:10%;">Serie</td> <td style="width:15%;"></td> <td style="width:10%; text-align: right;">68.0</td> </tr> <tr> <td>Total</td> <td></td> <td style="text-align: right;">0.0</td> </tr> </table> | Serie | | 68.0 | Total | | 0.0 | | | | | | | | | | | | | | | | | | |
| Serie | | 68.0 | | | | | | | | | | | | | | | | | | | | | | | |
| Total | | 0.0 | | | | | | | | | | | | | | | | | | | | | | | |

| | | | | | | | | | | | | | | | | | | | | | | | | | | | | | | | |
|-----------------------|--|-------|-----|------|-------|-----|------|----|-----|---|----|------|---|----|------|---|----|-----|---|----|-----|---|----|-----|---|----|-----|---|-----|------|---|
| <p>20 Skud</p> | <table style="width:100%; border-collapse: collapse;"> <tr><td style="width:10%;">1:</td><td style="width:15%;">9.9</td><td style="width:10%; text-align: center;">↖</td></tr> <tr><td>2:</td><td>9.0</td><td style="text-align: center;">↑</td></tr> <tr><td>3:</td><td>9.9</td><td style="text-align: center;">→</td></tr> <tr><td>4:</td><td>10.4</td><td style="text-align: center;">↗</td></tr> <tr><td>5:</td><td>10.1</td><td style="text-align: center;">↑</td></tr> <tr><td>6:</td><td>9.8</td><td style="text-align: center;">↑</td></tr> <tr><td>7:</td><td>8.9</td><td style="text-align: center;">↗</td></tr> <tr><td>8:</td><td>8.8</td><td style="text-align: center;">↑</td></tr> <tr><td>9:</td><td>9.3</td><td style="text-align: center;">↖</td></tr> <tr><td>10:</td><td>10.3</td><td style="text-align: center;">↑</td></tr> </table> | 1: | 9.9 | ↖ | 2: | 9.0 | ↑ | 3: | 9.9 | → | 4: | 10.4 | ↗ | 5: | 10.1 | ↑ | 6: | 9.8 | ↑ | 7: | 8.9 | ↗ | 8: | 8.8 | ↑ | 9: | 9.3 | ↖ | 10: | 10.3 | ↑ |
| 1: | 9.9 | ↖ | | | | | | | | | | | | | | | | | | | | | | | | | | | | | |
| 2: | 9.0 | ↑ | | | | | | | | | | | | | | | | | | | | | | | | | | | | | |
| 3: | 9.9 | → | | | | | | | | | | | | | | | | | | | | | | | | | | | | | |
| 4: | 10.4 | ↗ | | | | | | | | | | | | | | | | | | | | | | | | | | | | | |
| 5: | 10.1 | ↑ | | | | | | | | | | | | | | | | | | | | | | | | | | | | | |
| 6: | 9.8 | ↑ | | | | | | | | | | | | | | | | | | | | | | | | | | | | | |
| 7: | 8.9 | ↗ | | | | | | | | | | | | | | | | | | | | | | | | | | | | | |
| 8: | 8.8 | ↑ | | | | | | | | | | | | | | | | | | | | | | | | | | | | | |
| 9: | 9.3 | ↖ | | | | | | | | | | | | | | | | | | | | | | | | | | | | | |
| 10: | 10.3 | ↑ | | | | | | | | | | | | | | | | | | | | | | | | | | | | | |
| | <table style="width:100%; border-collapse: collapse;"> <tr> <td style="width:10%;">Serie</td> <td style="width:15%;"></td> <td style="width:10%; text-align: right;">91.0</td> </tr> <tr> <td>Total</td> <td></td> <td style="text-align: right;">91.0</td> </tr> </table> | Serie | | 91.0 | Total | | 91.0 | | | | | | | | | | | | | | | | | | | | | | | | |
| Serie | | 91.0 | | | | | | | | | | | | | | | | | | | | | | | | | | | | | |
| Total | | 91.0 | | | | | | | | | | | | | | | | | | | | | | | | | | | | | |

| | | | | | | | | | | | | | | | | | | | | | | | | | | | | | | | |
|-----------------------|---|-------|-----|------|-------|------|-------|-----|-----|---|-----|-----|---|-----|-------|---|-----|-----|---|-----|-----|---|-----|-----|---|-----|-----|---|-----|-----|---|
| <p>20 Skud</p> | <table style="width:100%; border-collapse: collapse;"> <tr><td style="width:10%;">11:</td><td style="width:15%;">9.2</td><td style="width:10%; text-align: center;">→</td></tr> <tr><td>12:</td><td>10.0</td><td style="text-align: center;">↓</td></tr> <tr><td>13:</td><td>9.1</td><td style="text-align: center;">↑</td></tr> <tr><td>14:</td><td>9.1</td><td style="text-align: center;">→</td></tr> <tr><td>15:</td><td>*10.6</td><td style="text-align: center;">↗</td></tr> <tr><td>16:</td><td>8.3</td><td style="text-align: center;">→</td></tr> <tr><td>17:</td><td>9.7</td><td style="text-align: center;">↑</td></tr> <tr><td>18:</td><td>9.6</td><td style="text-align: center;">↓</td></tr> <tr><td>19:</td><td>9.7</td><td style="text-align: center;">↗</td></tr> <tr><td>20:</td><td>9.1</td><td style="text-align: center;">→</td></tr> </table> | 11: | 9.2 | → | 12: | 10.0 | ↓ | 13: | 9.1 | ↑ | 14: | 9.1 | → | 15: | *10.6 | ↗ | 16: | 8.3 | → | 17: | 9.7 | ↑ | 18: | 9.6 | ↓ | 19: | 9.7 | ↗ | 20: | 9.1 | → |
| 11: | 9.2 | → | | | | | | | | | | | | | | | | | | | | | | | | | | | | | |
| 12: | 10.0 | ↓ | | | | | | | | | | | | | | | | | | | | | | | | | | | | | |
| 13: | 9.1 | ↑ | | | | | | | | | | | | | | | | | | | | | | | | | | | | | |
| 14: | 9.1 | → | | | | | | | | | | | | | | | | | | | | | | | | | | | | | |
| 15: | *10.6 | ↗ | | | | | | | | | | | | | | | | | | | | | | | | | | | | | |
| 16: | 8.3 | → | | | | | | | | | | | | | | | | | | | | | | | | | | | | | |
| 17: | 9.7 | ↑ | | | | | | | | | | | | | | | | | | | | | | | | | | | | | |
| 18: | 9.6 | ↓ | | | | | | | | | | | | | | | | | | | | | | | | | | | | | |
| 19: | 9.7 | ↗ | | | | | | | | | | | | | | | | | | | | | | | | | | | | | |
| 20: | 9.1 | → | | | | | | | | | | | | | | | | | | | | | | | | | | | | | |
| | <table style="width:100%; border-collapse: collapse;"> <tr> <td style="width:10%;">Serie</td> <td style="width:15%;"></td> <td style="width:10%; text-align: right;">91.0</td> </tr> <tr> <td>Total</td> <td></td> <td style="text-align: right;">182.0</td> </tr> </table> | Serie | | 91.0 | Total | | 182.0 | | | | | | | | | | | | | | | | | | | | | | | | |
| Serie | | 91.0 | | | | | | | | | | | | | | | | | | | | | | | | | | | | | |
| Total | | 182.0 | | | | | | | | | | | | | | | | | | | | | | | | | | | | | |

| | | | | | | | | | | | | | | | | | | | | |
|---------------------|---|----|------|---|----|-------|---|----|-------|---|----|------|---|----|-------|---|-------|------|-------|-----|
| <p>Prøve</p> | <table style="width:100%; border-collapse: collapse;"> <tr><td style="width:10%;">1:</td><td style="width:40%;">10.3</td><td style="width:50%; text-align: right;">→</td></tr> <tr><td>2:</td><td>*10.6</td><td style="text-align: right;">↗</td></tr> <tr><td>3:</td><td>*10.7</td><td style="text-align: right;">↗</td></tr> <tr><td>4:</td><td>10.4</td><td style="text-align: right;">↗</td></tr> <tr><td>5:</td><td>*10.8</td><td style="text-align: right;">↗</td></tr> </table> <table border="1" style="width:100%; border-collapse: collapse; margin-top: 5px;"> <tr> <td style="width:90%;">Serie</td> <td style="width:10%; text-align: right;">50.0</td> </tr> <tr> <td>Total</td> <td style="text-align: right;">0.0</td> </tr> </table> | 1: | 10.3 | → | 2: | *10.6 | ↗ | 3: | *10.7 | ↗ | 4: | 10.4 | ↗ | 5: | *10.8 | ↗ | Serie | 50.0 | Total | 0.0 |
| 1: | 10.3 | → | | | | | | | | | | | | | | | | | | |
| 2: | *10.6 | ↗ | | | | | | | | | | | | | | | | | | |
| 3: | *10.7 | ↗ | | | | | | | | | | | | | | | | | | |
| 4: | 10.4 | ↗ | | | | | | | | | | | | | | | | | | |
| 5: | *10.8 | ↗ | | | | | | | | | | | | | | | | | | |
| Serie | 50.0 | | | | | | | | | | | | | | | | | | | |
| Total | 0.0 | | | | | | | | | | | | | | | | | | | |

| | | | | | | | | | | | | | | | | | | | | | | | | | | | | | | | | | | | |
|-----------------------|---|----|-------|---|----|-----|---|----|-------|---|----|------|---|----|------|---|----|------|---|----|-----|---|----|-------|---|----|-------|---|-----|------|---|-------|------|-------|------|
| <p>20 Skud</p> | <table style="width:100%; border-collapse: collapse;"> <tr><td style="width:10%;">1:</td><td style="width:40%;">*10.5</td><td style="width:50%; text-align: right;">↘</td></tr> <tr><td>2:</td><td>9.8</td><td style="text-align: right;">←</td></tr> <tr><td>3:</td><td>*10.6</td><td style="text-align: right;">↑</td></tr> <tr><td>4:</td><td>10.2</td><td style="text-align: right;">↗</td></tr> <tr><td>5:</td><td>10.3</td><td style="text-align: right;">↗</td></tr> <tr><td>6:</td><td>10.4</td><td style="text-align: right;">↘</td></tr> <tr><td>7:</td><td>9.9</td><td style="text-align: right;">↗</td></tr> <tr><td>8:</td><td>*10.6</td><td style="text-align: right;">↑</td></tr> <tr><td>9:</td><td>*10.9</td><td style="text-align: right;">→</td></tr> <tr><td>10:</td><td>10.1</td><td style="text-align: right;">↗</td></tr> </table> <table border="1" style="width:100%; border-collapse: collapse; margin-top: 5px;"> <tr> <td style="width:90%;">Serie</td> <td style="width:10%; text-align: right;">98.0</td> </tr> <tr> <td>Total</td> <td style="text-align: right;">98.0</td> </tr> </table> | 1: | *10.5 | ↘ | 2: | 9.8 | ← | 3: | *10.6 | ↑ | 4: | 10.2 | ↗ | 5: | 10.3 | ↗ | 6: | 10.4 | ↘ | 7: | 9.9 | ↗ | 8: | *10.6 | ↑ | 9: | *10.9 | → | 10: | 10.1 | ↗ | Serie | 98.0 | Total | 98.0 |
| 1: | *10.5 | ↘ | | | | | | | | | | | | | | | | | | | | | | | | | | | | | | | | | |
| 2: | 9.8 | ← | | | | | | | | | | | | | | | | | | | | | | | | | | | | | | | | | |
| 3: | *10.6 | ↑ | | | | | | | | | | | | | | | | | | | | | | | | | | | | | | | | | |
| 4: | 10.2 | ↗ | | | | | | | | | | | | | | | | | | | | | | | | | | | | | | | | | |
| 5: | 10.3 | ↗ | | | | | | | | | | | | | | | | | | | | | | | | | | | | | | | | | |
| 6: | 10.4 | ↘ | | | | | | | | | | | | | | | | | | | | | | | | | | | | | | | | | |
| 7: | 9.9 | ↗ | | | | | | | | | | | | | | | | | | | | | | | | | | | | | | | | | |
| 8: | *10.6 | ↑ | | | | | | | | | | | | | | | | | | | | | | | | | | | | | | | | | |
| 9: | *10.9 | → | | | | | | | | | | | | | | | | | | | | | | | | | | | | | | | | | |
| 10: | 10.1 | ↗ | | | | | | | | | | | | | | | | | | | | | | | | | | | | | | | | | |
| Serie | 98.0 | | | | | | | | | | | | | | | | | | | | | | | | | | | | | | | | | | |
| Total | 98.0 | | | | | | | | | | | | | | | | | | | | | | | | | | | | | | | | | | |

| | | | | | | | | | | | | | | | | | | | | | | | | | | | | | | | | | | | |
|-----------------------|--|-----|-------|---|-----|-------|---|-----|-------|---|-----|------|---|-----|-------|---|-----|------|---|-----|------|---|-----|-------|---|-----|-------|---|-----|-----|---|-------|------|-------|-------|
| <p>20 Skud</p> | <table style="width:100%; border-collapse: collapse;"> <tr><td style="width:10%;">11:</td><td style="width:40%;">*10.8</td><td style="width:50%; text-align: right;">↘</td></tr> <tr><td>12:</td><td>*10.6</td><td style="text-align: right;">↘</td></tr> <tr><td>13:</td><td>*10.5</td><td style="text-align: right;">←</td></tr> <tr><td>14:</td><td>10.4</td><td style="text-align: right;">↑</td></tr> <tr><td>15:</td><td>*10.8</td><td style="text-align: right;">↗</td></tr> <tr><td>16:</td><td>10.2</td><td style="text-align: right;">↗</td></tr> <tr><td>17:</td><td>10.4</td><td style="text-align: right;">↘</td></tr> <tr><td>18:</td><td>*10.6</td><td style="text-align: right;">←</td></tr> <tr><td>19:</td><td>*10.7</td><td style="text-align: right;">↗</td></tr> <tr><td>20:</td><td>9.9</td><td style="text-align: right;">↑</td></tr> </table> <table border="1" style="width:100%; border-collapse: collapse; margin-top: 5px;"> <tr> <td style="width:90%;">Serie</td> <td style="width:10%; text-align: right;">99.0</td> </tr> <tr> <td>Total</td> <td style="text-align: right;">197.0</td> </tr> </table> | 11: | *10.8 | ↘ | 12: | *10.6 | ↘ | 13: | *10.5 | ← | 14: | 10.4 | ↑ | 15: | *10.8 | ↗ | 16: | 10.2 | ↗ | 17: | 10.4 | ↘ | 18: | *10.6 | ← | 19: | *10.7 | ↗ | 20: | 9.9 | ↑ | Serie | 99.0 | Total | 197.0 |
| 11: | *10.8 | ↘ | | | | | | | | | | | | | | | | | | | | | | | | | | | | | | | | | |
| 12: | *10.6 | ↘ | | | | | | | | | | | | | | | | | | | | | | | | | | | | | | | | | |
| 13: | *10.5 | ← | | | | | | | | | | | | | | | | | | | | | | | | | | | | | | | | | |
| 14: | 10.4 | ↑ | | | | | | | | | | | | | | | | | | | | | | | | | | | | | | | | | |
| 15: | *10.8 | ↗ | | | | | | | | | | | | | | | | | | | | | | | | | | | | | | | | | |
| 16: | 10.2 | ↗ | | | | | | | | | | | | | | | | | | | | | | | | | | | | | | | | | |
| 17: | 10.4 | ↘ | | | | | | | | | | | | | | | | | | | | | | | | | | | | | | | | | |
| 18: | *10.6 | ← | | | | | | | | | | | | | | | | | | | | | | | | | | | | | | | | | |
| 19: | *10.7 | ↗ | | | | | | | | | | | | | | | | | | | | | | | | | | | | | | | | | |
| 20: | 9.9 | ↑ | | | | | | | | | | | | | | | | | | | | | | | | | | | | | | | | | |
| Serie | 99.0 | | | | | | | | | | | | | | | | | | | | | | | | | | | | | | | | | | |
| Total | 197.0 | | | | | | | | | | | | | | | | | | | | | | | | | | | | | | | | | | |

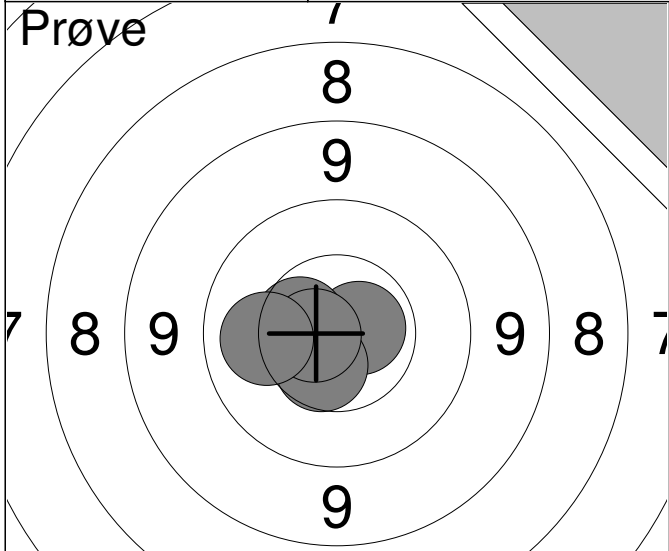
| | | | | | | | | | | | | | | | | |
|--|---|----|-------|---|----|------|---|----|------|---|----|-------|---|----|------|---|
| <p>Prøve</p>  | <table style="width:100%; border-collapse: collapse;"> <tr><td style="width:10%;">1:</td><td style="width:10%;">*10.7</td><td style="width:10%; text-align: right;">→</td></tr> <tr><td>2:</td><td>10.5</td><td style="text-align: right;">↓</td></tr> <tr><td>3:</td><td>10.5</td><td style="text-align: right;">←</td></tr> <tr><td>4:</td><td>*10.7</td><td style="text-align: right;">←</td></tr> <tr><td>5:</td><td>10.1</td><td style="text-align: right;">←</td></tr> </table> | 1: | *10.7 | → | 2: | 10.5 | ↓ | 3: | 10.5 | ← | 4: | *10.7 | ← | 5: | 10.1 | ← |
| 1: | *10.7 | → | | | | | | | | | | | | | | |
| 2: | 10.5 | ↓ | | | | | | | | | | | | | | |
| 3: | 10.5 | ← | | | | | | | | | | | | | | |
| 4: | *10.7 | ← | | | | | | | | | | | | | | |
| 5: | 10.1 | ← | | | | | | | | | | | | | | |

| | |
|-------|------|
| Serie | 50.0 |
| Total | 0.0 |

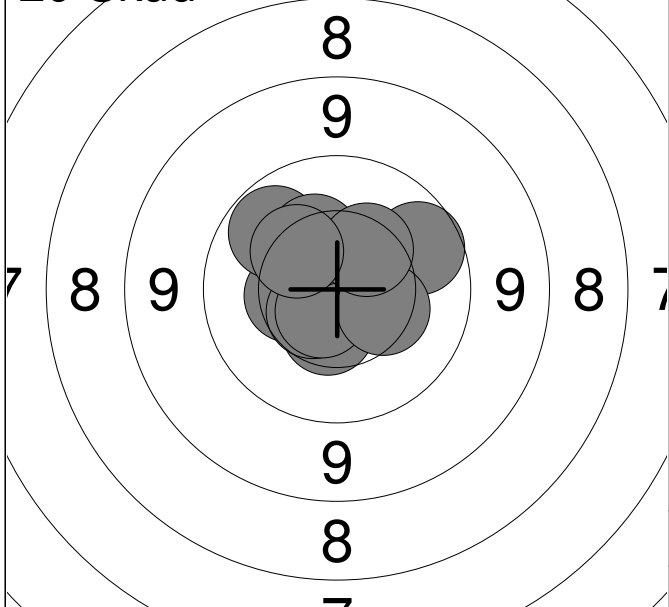
| | | | | | | | | | | | | | | | | | | | | | | | | | | | | | | | |
|---|---|----|------|---|----|------|---|----|------|---|----|-------|---|----|------|---|----|-----|---|----|------|---|----|------|---|----|------|---|-----|------|---|
| <p>20 Skud</p>  | <table style="width:100%; border-collapse: collapse;"> <tr><td style="width:10%;">1:</td><td style="width:10%;">10.4</td><td style="width:10%; text-align: right;">←</td></tr> <tr><td>2:</td><td>10.5</td><td style="text-align: right;">↓</td></tr> <tr><td>3:</td><td>10.6</td><td style="text-align: right;">↙</td></tr> <tr><td>4:</td><td>*10.6</td><td style="text-align: right;">↙</td></tr> <tr><td>5:</td><td>10.0</td><td style="text-align: right;">↗</td></tr> <tr><td>6:</td><td>9.9</td><td style="text-align: right;">↗</td></tr> <tr><td>7:</td><td>10.3</td><td style="text-align: right;">↑</td></tr> <tr><td>8:</td><td>10.4</td><td style="text-align: right;">↘</td></tr> <tr><td>9:</td><td>10.4</td><td style="text-align: right;">↗</td></tr> <tr><td>10:</td><td>10.3</td><td style="text-align: right;">↖</td></tr> </table> | 1: | 10.4 | ← | 2: | 10.5 | ↓ | 3: | 10.6 | ↙ | 4: | *10.6 | ↙ | 5: | 10.0 | ↗ | 6: | 9.9 | ↗ | 7: | 10.3 | ↑ | 8: | 10.4 | ↘ | 9: | 10.4 | ↗ | 10: | 10.3 | ↖ |
| 1: | 10.4 | ← | | | | | | | | | | | | | | | | | | | | | | | | | | | | | |
| 2: | 10.5 | ↓ | | | | | | | | | | | | | | | | | | | | | | | | | | | | | |
| 3: | 10.6 | ↙ | | | | | | | | | | | | | | | | | | | | | | | | | | | | | |
| 4: | *10.6 | ↙ | | | | | | | | | | | | | | | | | | | | | | | | | | | | | |
| 5: | 10.0 | ↗ | | | | | | | | | | | | | | | | | | | | | | | | | | | | | |
| 6: | 9.9 | ↗ | | | | | | | | | | | | | | | | | | | | | | | | | | | | | |
| 7: | 10.3 | ↑ | | | | | | | | | | | | | | | | | | | | | | | | | | | | | |
| 8: | 10.4 | ↘ | | | | | | | | | | | | | | | | | | | | | | | | | | | | | |
| 9: | 10.4 | ↗ | | | | | | | | | | | | | | | | | | | | | | | | | | | | | |
| 10: | 10.3 | ↖ | | | | | | | | | | | | | | | | | | | | | | | | | | | | | |

| | |
|-------|------|
| Serie | 99.0 |
| Total | 99.0 |

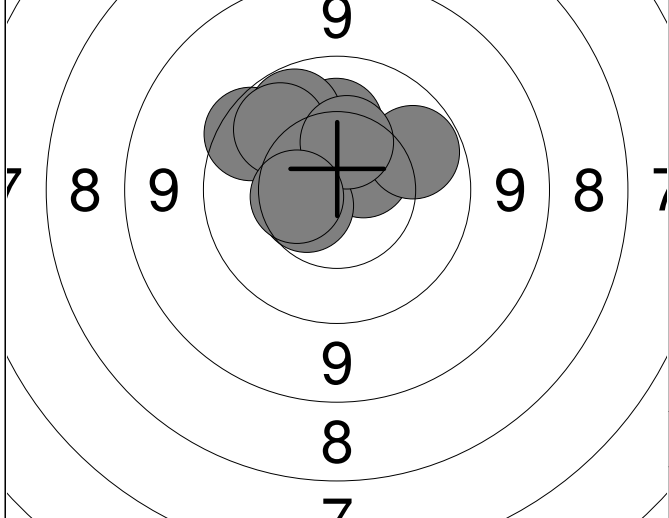
| | | | | | | | | | | | | | | | | | | | | | | | | | | | | | | | |
|--|---|-----|------|---|-----|------|---|-----|-----|---|-----|------|---|-----|------|---|-----|------|---|-----|------|---|-----|------|---|-----|------|---|-----|------|---|
| <p>20 Skud</p>  | <table style="width:100%; border-collapse: collapse;"> <tr><td style="width:10%;">11:</td><td style="width:10%;">10.4</td><td style="width:10%; text-align: right;">↑</td></tr> <tr><td>12:</td><td>10.6</td><td style="text-align: right;">↗</td></tr> <tr><td>13:</td><td>9.7</td><td style="text-align: right;">↖</td></tr> <tr><td>14:</td><td>10.2</td><td style="text-align: right;">↑</td></tr> <tr><td>15:</td><td>10.0</td><td style="text-align: right;">↗</td></tr> <tr><td>16:</td><td>10.0</td><td style="text-align: right;">↗</td></tr> <tr><td>17:</td><td>10.0</td><td style="text-align: right;">↗</td></tr> <tr><td>18:</td><td>10.6</td><td style="text-align: right;">↖</td></tr> <tr><td>19:</td><td>10.4</td><td style="text-align: right;">↑</td></tr> <tr><td>20:</td><td>10.5</td><td style="text-align: right;">←</td></tr> </table> | 11: | 10.4 | ↑ | 12: | 10.6 | ↗ | 13: | 9.7 | ↖ | 14: | 10.2 | ↑ | 15: | 10.0 | ↗ | 16: | 10.0 | ↗ | 17: | 10.0 | ↗ | 18: | 10.6 | ↖ | 19: | 10.4 | ↑ | 20: | 10.5 | ← |
| 11: | 10.4 | ↑ | | | | | | | | | | | | | | | | | | | | | | | | | | | | | |
| 12: | 10.6 | ↗ | | | | | | | | | | | | | | | | | | | | | | | | | | | | | |
| 13: | 9.7 | ↖ | | | | | | | | | | | | | | | | | | | | | | | | | | | | | |
| 14: | 10.2 | ↑ | | | | | | | | | | | | | | | | | | | | | | | | | | | | | |
| 15: | 10.0 | ↗ | | | | | | | | | | | | | | | | | | | | | | | | | | | | | |
| 16: | 10.0 | ↗ | | | | | | | | | | | | | | | | | | | | | | | | | | | | | |
| 17: | 10.0 | ↗ | | | | | | | | | | | | | | | | | | | | | | | | | | | | | |
| 18: | 10.6 | ↖ | | | | | | | | | | | | | | | | | | | | | | | | | | | | | |
| 19: | 10.4 | ↑ | | | | | | | | | | | | | | | | | | | | | | | | | | | | | |
| 20: | 10.5 | ← | | | | | | | | | | | | | | | | | | | | | | | | | | | | | |

| | |
|-------|-------|
| Serie | 99.0 |
| Total | 198.0 |

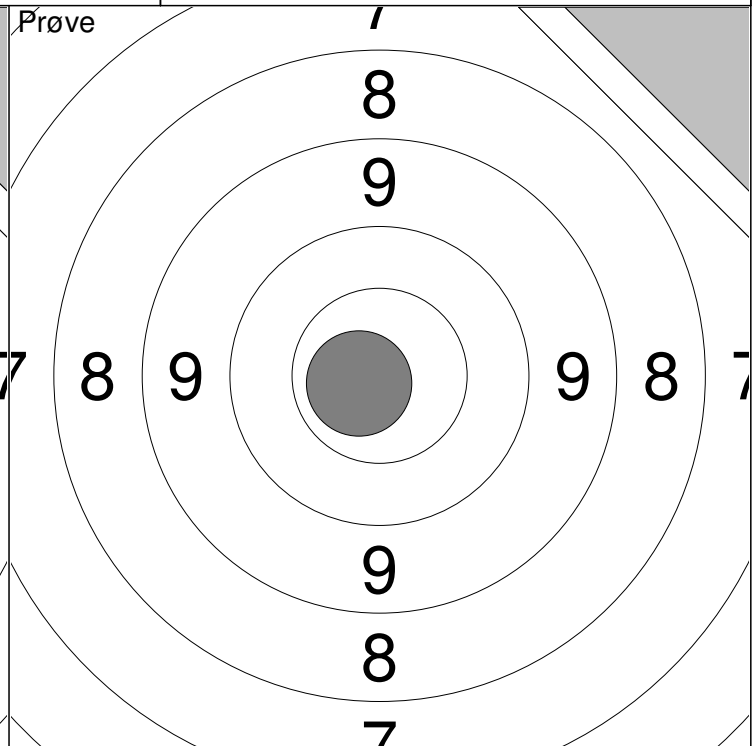
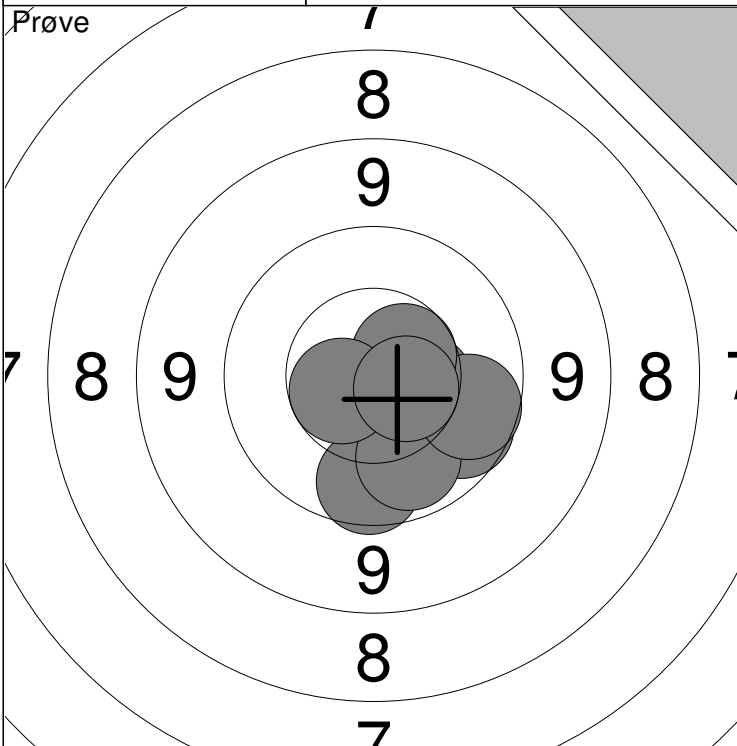

| | | | |
|------------|-------------|-------|------|
| 1: *10.6 ↓ | 6: 10.0 ↓ | Serie | 97.0 |
| 2: 9.8 ↓ | 7: 9.9 → | | |
| 3: 10.4 → | 8: 10.6 ↗ | Total | 0.0 |
| 4: 10.3 ↘ | 9: 10.6 ↖ | | |
| 5: 9.9 ↘ | 10: *10.6 ↗ | | |

| | | |
|-------------|-------|------|
| 11: *10.7 ← | Serie | 10.0 |
| | | |
| | Total | 0.0 |
| | | |

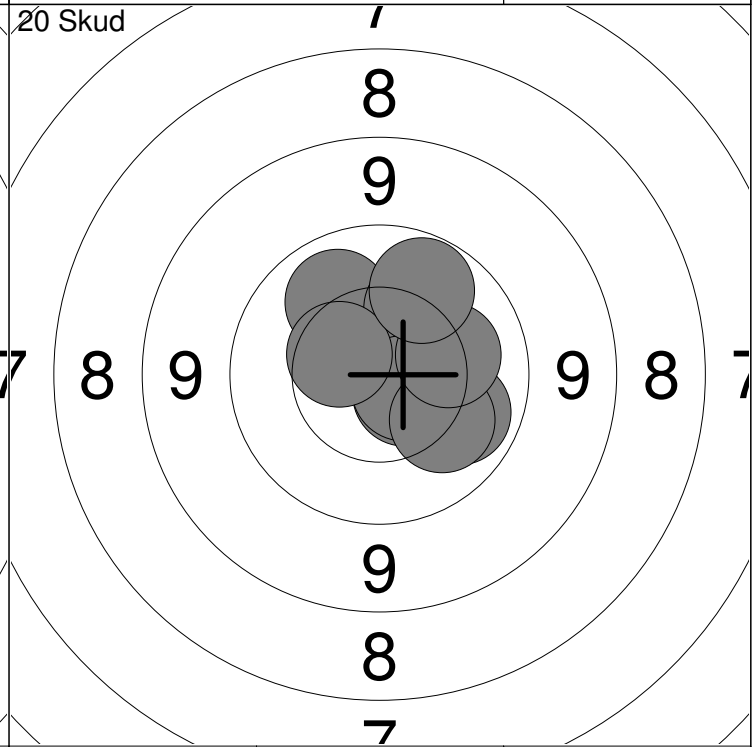
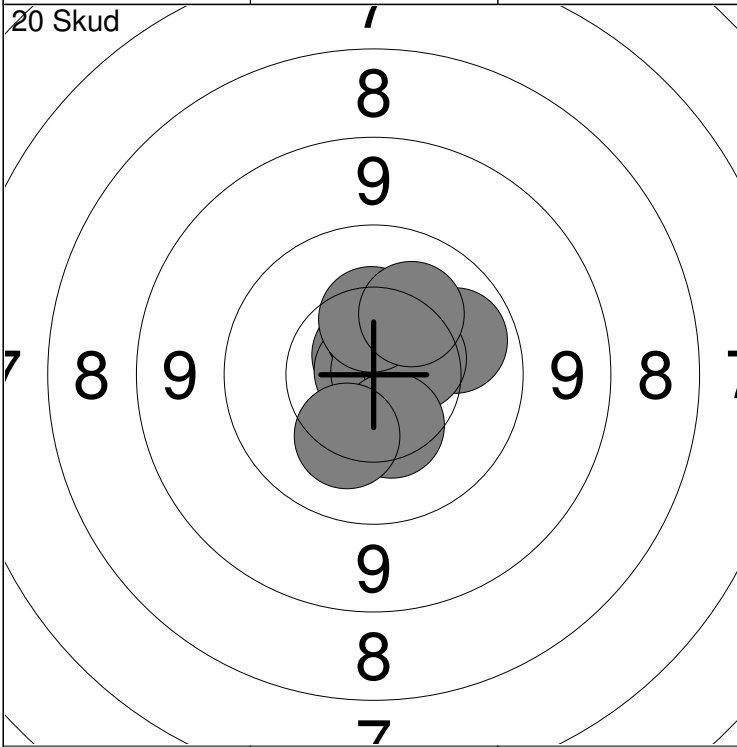

| | | | |
|------------|------------|-------|-------|
| 1: *10.7 ↗ | 6: 10.5 → | Serie | 100.0 |
| 2: *10.9 ↖ | 7: 10.4 ↑ | | |
| 3: 10.5 ↑ | 8: 10.2 ↗ | Total | 100.0 |
| 4: *10.8 → | 9: 10.4 ↓ | | |
| 5: 10.0 → | 10: 10.3 ↓ | | |

| | | | |
|-------------|-------------|-------|-------|
| 11: 10.1 ↗ | 16: *10.7 ↓ | Serie | 100.0 |
| 12: *10.6 ↓ | 17: 10.5 ↗ | | |
| 13: 10.1 → | 18: 10.1 ↓ | Total | 200.0 |
| 14: 10.2 ↗ | 19: 10.2 → | | |
| 15: 10.5 → | 20: 10.0 ↗ | | |

| | | | | | | | | | | | | | | | | | | | | | | | | | | | | | | | | | | | | | |
|---------------------|---|-------------|------|---|----|------|---|----|-----|---|----|-------|---|----|------|---|----|------|---|----|-------|---|----|------|---|----|------|---|-----|------|---|--------------|--|-------------|--------------|--|------------|
| <p>Prøve</p> | <table style="width:100%; border-collapse: collapse;"> <tr><td style="width:10%;">1:</td><td style="width:20%;">10.0</td><td style="width:10%; text-align: center;">↗</td></tr> <tr><td>2:</td><td>10.5</td><td style="text-align: center;">↑</td></tr> <tr><td>3:</td><td>9.7</td><td style="text-align: center;">↗</td></tr> <tr><td>4:</td><td>*10.6</td><td style="text-align: center;">↘</td></tr> <tr><td>5:</td><td>10.6</td><td style="text-align: center;">↘</td></tr> <tr><td>6:</td><td>10.0</td><td style="text-align: center;">↘</td></tr> <tr><td>7:</td><td>*10.6</td><td style="text-align: center;">↖</td></tr> <tr><td>8:</td><td>10.2</td><td style="text-align: center;">↘</td></tr> <tr><td>9:</td><td>10.5</td><td style="text-align: center;">↖</td></tr> <tr><td>10:</td><td>10.5</td><td style="text-align: center;">↗</td></tr> <tr><td colspan="2">Serie</td><td style="text-align: right;">99.0</td></tr> <tr><td colspan="2">Total</td><td style="text-align: right;">0.0</td></tr> </table> | 1: | 10.0 | ↗ | 2: | 10.5 | ↑ | 3: | 9.7 | ↗ | 4: | *10.6 | ↘ | 5: | 10.6 | ↘ | 6: | 10.0 | ↘ | 7: | *10.6 | ↖ | 8: | 10.2 | ↘ | 9: | 10.5 | ↖ | 10: | 10.5 | ↗ | Serie | | 99.0 | Total | | 0.0 |
| 1: | 10.0 | ↗ | | | | | | | | | | | | | | | | | | | | | | | | | | | | | | | | | | | |
| 2: | 10.5 | ↑ | | | | | | | | | | | | | | | | | | | | | | | | | | | | | | | | | | | |
| 3: | 9.7 | ↗ | | | | | | | | | | | | | | | | | | | | | | | | | | | | | | | | | | | |
| 4: | *10.6 | ↘ | | | | | | | | | | | | | | | | | | | | | | | | | | | | | | | | | | | |
| 5: | 10.6 | ↘ | | | | | | | | | | | | | | | | | | | | | | | | | | | | | | | | | | | |
| 6: | 10.0 | ↘ | | | | | | | | | | | | | | | | | | | | | | | | | | | | | | | | | | | |
| 7: | *10.6 | ↖ | | | | | | | | | | | | | | | | | | | | | | | | | | | | | | | | | | | |
| 8: | 10.2 | ↘ | | | | | | | | | | | | | | | | | | | | | | | | | | | | | | | | | | | |
| 9: | 10.5 | ↖ | | | | | | | | | | | | | | | | | | | | | | | | | | | | | | | | | | | |
| 10: | 10.5 | ↗ | | | | | | | | | | | | | | | | | | | | | | | | | | | | | | | | | | | |
| Serie | | 99.0 | | | | | | | | | | | | | | | | | | | | | | | | | | | | | | | | | | | |
| Total | | 0.0 | | | | | | | | | | | | | | | | | | | | | | | | | | | | | | | | | | | |

| | | | | | | | | | | | | | | | | | | | | | | | | | | | | | | | | | | | | | |
|-----------------------|--|-------------|-------|---|----|-----|---|----|------|---|----|------|---|----|------|---|----|-------|---|----|------|---|----|------|---|----|------|---|-----|------|---|--------------|--|-------------|--------------|--|-------------|
| <p>20 Skud</p> | <table style="width:100%; border-collapse: collapse;"> <tr><td style="width:10%;">1:</td><td style="width:20%;">*10.7</td><td style="width:10%; text-align: center;">↑</td></tr> <tr><td>2:</td><td>9.9</td><td style="text-align: center;">↗</td></tr> <tr><td>3:</td><td>10.0</td><td style="text-align: center;">↑</td></tr> <tr><td>4:</td><td>10.4</td><td style="text-align: center;">↖</td></tr> <tr><td>5:</td><td>10.4</td><td style="text-align: center;">↗</td></tr> <tr><td>6:</td><td>*10.8</td><td style="text-align: center;">→</td></tr> <tr><td>7:</td><td>10.5</td><td style="text-align: center;">↖</td></tr> <tr><td>8:</td><td>10.5</td><td style="text-align: center;">↘</td></tr> <tr><td>9:</td><td>10.5</td><td style="text-align: center;">↗</td></tr> <tr><td>10:</td><td>10.1</td><td style="text-align: center;">↖</td></tr> <tr><td colspan="2">Serie</td><td style="text-align: right;">99.0</td></tr> <tr><td colspan="2">Total</td><td style="text-align: right;">99.0</td></tr> </table> | 1: | *10.7 | ↑ | 2: | 9.9 | ↗ | 3: | 10.0 | ↑ | 4: | 10.4 | ↖ | 5: | 10.4 | ↗ | 6: | *10.8 | → | 7: | 10.5 | ↖ | 8: | 10.5 | ↘ | 9: | 10.5 | ↗ | 10: | 10.1 | ↖ | Serie | | 99.0 | Total | | 99.0 |
| 1: | *10.7 | ↑ | | | | | | | | | | | | | | | | | | | | | | | | | | | | | | | | | | | |
| 2: | 9.9 | ↗ | | | | | | | | | | | | | | | | | | | | | | | | | | | | | | | | | | | |
| 3: | 10.0 | ↑ | | | | | | | | | | | | | | | | | | | | | | | | | | | | | | | | | | | |
| 4: | 10.4 | ↖ | | | | | | | | | | | | | | | | | | | | | | | | | | | | | | | | | | | |
| 5: | 10.4 | ↗ | | | | | | | | | | | | | | | | | | | | | | | | | | | | | | | | | | | |
| 6: | *10.8 | → | | | | | | | | | | | | | | | | | | | | | | | | | | | | | | | | | | | |
| 7: | 10.5 | ↖ | | | | | | | | | | | | | | | | | | | | | | | | | | | | | | | | | | | |
| 8: | 10.5 | ↘ | | | | | | | | | | | | | | | | | | | | | | | | | | | | | | | | | | | |
| 9: | 10.5 | ↗ | | | | | | | | | | | | | | | | | | | | | | | | | | | | | | | | | | | |
| 10: | 10.1 | ↖ | | | | | | | | | | | | | | | | | | | | | | | | | | | | | | | | | | | |
| Serie | | 99.0 | | | | | | | | | | | | | | | | | | | | | | | | | | | | | | | | | | | |
| Total | | 99.0 | | | | | | | | | | | | | | | | | | | | | | | | | | | | | | | | | | | |

| | | | | | | | | | | | | | | | | | | | | | | | | | | | | | | | | | | | | | |
|-----------------------|--|--------------|------|---|-----|-------|---|-----|-------|---|-----|------|---|-----|------|---|-----|-----|---|-----|------|---|-----|------|---|-----|------|---|-----|------|---|--------------|--|-------------|--------------|--|--------------|
| <p>20 Skud</p> | <table style="width:100%; border-collapse: collapse;"> <tr><td style="width:10%;">11:</td><td style="width:20%;">10.3</td><td style="width:10%; text-align: center;">→</td></tr> <tr><td>12:</td><td>*10.7</td><td style="text-align: center;">↗</td></tr> <tr><td>13:</td><td>*10.7</td><td style="text-align: center;">↗</td></tr> <tr><td>14:</td><td>10.3</td><td style="text-align: center;">↗</td></tr> <tr><td>15:</td><td>10.2</td><td style="text-align: center;">↘</td></tr> <tr><td>16:</td><td>9.6</td><td style="text-align: center;">↖</td></tr> <tr><td>17:</td><td>10.6</td><td style="text-align: center;">↗</td></tr> <tr><td>18:</td><td>10.4</td><td style="text-align: center;">↖</td></tr> <tr><td>19:</td><td>10.0</td><td style="text-align: center;">→</td></tr> <tr><td>20:</td><td>10.5</td><td style="text-align: center;">↗</td></tr> <tr><td colspan="2">Serie</td><td style="text-align: right;">99.0</td></tr> <tr><td colspan="2">Total</td><td style="text-align: right;">198.0</td></tr> </table> | 11: | 10.3 | → | 12: | *10.7 | ↗ | 13: | *10.7 | ↗ | 14: | 10.3 | ↗ | 15: | 10.2 | ↘ | 16: | 9.6 | ↖ | 17: | 10.6 | ↗ | 18: | 10.4 | ↖ | 19: | 10.0 | → | 20: | 10.5 | ↗ | Serie | | 99.0 | Total | | 198.0 |
| 11: | 10.3 | → | | | | | | | | | | | | | | | | | | | | | | | | | | | | | | | | | | | |
| 12: | *10.7 | ↗ | | | | | | | | | | | | | | | | | | | | | | | | | | | | | | | | | | | |
| 13: | *10.7 | ↗ | | | | | | | | | | | | | | | | | | | | | | | | | | | | | | | | | | | |
| 14: | 10.3 | ↗ | | | | | | | | | | | | | | | | | | | | | | | | | | | | | | | | | | | |
| 15: | 10.2 | ↘ | | | | | | | | | | | | | | | | | | | | | | | | | | | | | | | | | | | |
| 16: | 9.6 | ↖ | | | | | | | | | | | | | | | | | | | | | | | | | | | | | | | | | | | |
| 17: | 10.6 | ↗ | | | | | | | | | | | | | | | | | | | | | | | | | | | | | | | | | | | |
| 18: | 10.4 | ↖ | | | | | | | | | | | | | | | | | | | | | | | | | | | | | | | | | | | |
| 19: | 10.0 | → | | | | | | | | | | | | | | | | | | | | | | | | | | | | | | | | | | | |
| 20: | 10.5 | ↗ | | | | | | | | | | | | | | | | | | | | | | | | | | | | | | | | | | | |
| Serie | | 99.0 | | | | | | | | | | | | | | | | | | | | | | | | | | | | | | | | | | | |
| Total | | 198.0 | | | | | | | | | | | | | | | | | | | | | | | | | | | | | | | | | | | |

| | | | | | | | | | | | | | | | | | | | | | | | | | | | | | | | | | | | | | |
|-----------------------|---|-------|-------|---|-----|-------|---|-----|------|---|-----|------|---|-----|------|---|-----|------|---|-----|-------|---|-----|------|---|-----|-------|---|-----|------|---|-------|--|------|-------|--|-------|
| <p>Prøve</p> | <table style="width:100%; border-collapse: collapse;"> <tr><td style="width:10%;">1:</td><td style="width:15%;">10.2</td><td style="width:10%; text-align: center;">↗</td></tr> <tr><td>2:</td><td>10.2</td><td style="text-align: center;">↘</td></tr> <tr><td>3:</td><td>9.2</td><td style="text-align: center;">↖</td></tr> <tr><td>4:</td><td>10.3</td><td style="text-align: center;">↗</td></tr> <tr><td>5:</td><td>10.6</td><td style="text-align: center;">↘</td></tr> <tr><td>6:</td><td>10.0</td><td style="text-align: center;">↗</td></tr> <tr><td>7:</td><td>10.4</td><td style="text-align: center;">↘</td></tr> <tr><td>8:</td><td>10.1</td><td style="text-align: center;">↖</td></tr> <tr><td>9:</td><td>10.3</td><td style="text-align: center;">↘</td></tr> <tr><td>10:</td><td>10.3</td><td style="text-align: center;">↗</td></tr> <tr><td colspan="2">Serie</td><td style="text-align: right;">99.0</td></tr> <tr><td colspan="2">Total</td><td style="text-align: right;">0.0</td></tr> </table> | 1: | 10.2 | ↗ | 2: | 10.2 | ↘ | 3: | 9.2 | ↖ | 4: | 10.3 | ↗ | 5: | 10.6 | ↘ | 6: | 10.0 | ↗ | 7: | 10.4 | ↘ | 8: | 10.1 | ↖ | 9: | 10.3 | ↘ | 10: | 10.3 | ↗ | Serie | | 99.0 | Total | | 0.0 |
| 1: | 10.2 | ↗ | | | | | | | | | | | | | | | | | | | | | | | | | | | | | | | | | | | |
| 2: | 10.2 | ↘ | | | | | | | | | | | | | | | | | | | | | | | | | | | | | | | | | | | |
| 3: | 9.2 | ↖ | | | | | | | | | | | | | | | | | | | | | | | | | | | | | | | | | | | |
| 4: | 10.3 | ↗ | | | | | | | | | | | | | | | | | | | | | | | | | | | | | | | | | | | |
| 5: | 10.6 | ↘ | | | | | | | | | | | | | | | | | | | | | | | | | | | | | | | | | | | |
| 6: | 10.0 | ↗ | | | | | | | | | | | | | | | | | | | | | | | | | | | | | | | | | | | |
| 7: | 10.4 | ↘ | | | | | | | | | | | | | | | | | | | | | | | | | | | | | | | | | | | |
| 8: | 10.1 | ↖ | | | | | | | | | | | | | | | | | | | | | | | | | | | | | | | | | | | |
| 9: | 10.3 | ↘ | | | | | | | | | | | | | | | | | | | | | | | | | | | | | | | | | | | |
| 10: | 10.3 | ↗ | | | | | | | | | | | | | | | | | | | | | | | | | | | | | | | | | | | |
| Serie | | 99.0 | | | | | | | | | | | | | | | | | | | | | | | | | | | | | | | | | | | |
| Total | | 0.0 | | | | | | | | | | | | | | | | | | | | | | | | | | | | | | | | | | | |
| <p>20 Skud</p> | <table style="width:100%; border-collapse: collapse;"> <tr><td style="width:10%;">1:</td><td style="width:15%;">*10.7</td><td style="width:10%; text-align: center;">↗</td></tr> <tr><td>2:</td><td>*10.8</td><td style="text-align: center;">↘</td></tr> <tr><td>3:</td><td>10.6</td><td style="text-align: center;">↖</td></tr> <tr><td>4:</td><td>10.5</td><td style="text-align: center;">↗</td></tr> <tr><td>5:</td><td>9.9</td><td style="text-align: center;">↗</td></tr> <tr><td>6:</td><td>9.1</td><td style="text-align: center;">→</td></tr> <tr><td>7:</td><td>*10.7</td><td style="text-align: center;">↖</td></tr> <tr><td>8:</td><td>10.3</td><td style="text-align: center;">↖</td></tr> <tr><td>9:</td><td>9.6</td><td style="text-align: center;">↖</td></tr> <tr><td>10:</td><td>10.1</td><td style="text-align: center;">↖</td></tr> <tr><td colspan="2">Serie</td><td style="text-align: right;">97.0</td></tr> <tr><td colspan="2">Total</td><td style="text-align: right;">97.0</td></tr> </table> | 1: | *10.7 | ↗ | 2: | *10.8 | ↘ | 3: | 10.6 | ↖ | 4: | 10.5 | ↗ | 5: | 9.9 | ↗ | 6: | 9.1 | → | 7: | *10.7 | ↖ | 8: | 10.3 | ↖ | 9: | 9.6 | ↖ | 10: | 10.1 | ↖ | Serie | | 97.0 | Total | | 97.0 |
| 1: | *10.7 | ↗ | | | | | | | | | | | | | | | | | | | | | | | | | | | | | | | | | | | |
| 2: | *10.8 | ↘ | | | | | | | | | | | | | | | | | | | | | | | | | | | | | | | | | | | |
| 3: | 10.6 | ↖ | | | | | | | | | | | | | | | | | | | | | | | | | | | | | | | | | | | |
| 4: | 10.5 | ↗ | | | | | | | | | | | | | | | | | | | | | | | | | | | | | | | | | | | |
| 5: | 9.9 | ↗ | | | | | | | | | | | | | | | | | | | | | | | | | | | | | | | | | | | |
| 6: | 9.1 | → | | | | | | | | | | | | | | | | | | | | | | | | | | | | | | | | | | | |
| 7: | *10.7 | ↖ | | | | | | | | | | | | | | | | | | | | | | | | | | | | | | | | | | | |
| 8: | 10.3 | ↖ | | | | | | | | | | | | | | | | | | | | | | | | | | | | | | | | | | | |
| 9: | 9.6 | ↖ | | | | | | | | | | | | | | | | | | | | | | | | | | | | | | | | | | | |
| 10: | 10.1 | ↖ | | | | | | | | | | | | | | | | | | | | | | | | | | | | | | | | | | | |
| Serie | | 97.0 | | | | | | | | | | | | | | | | | | | | | | | | | | | | | | | | | | | |
| Total | | 97.0 | | | | | | | | | | | | | | | | | | | | | | | | | | | | | | | | | | | |
| <p>20 Skud</p> | <table style="width:100%; border-collapse: collapse;"> <tr><td style="width:10%;">11:</td><td style="width:15%;">10.1</td><td style="width:10%; text-align: center;">↗</td></tr> <tr><td>12:</td><td>10.0</td><td style="text-align: center;">↘</td></tr> <tr><td>13:</td><td>10.1</td><td style="text-align: center;">↘</td></tr> <tr><td>14:</td><td>10.0</td><td style="text-align: center;">↗</td></tr> <tr><td>15:</td><td>10.0</td><td style="text-align: center;">↖</td></tr> <tr><td>16:</td><td>10.6</td><td style="text-align: center;">↗</td></tr> <tr><td>17:</td><td>10.1</td><td style="text-align: center;">↘</td></tr> <tr><td>18:</td><td>8.8</td><td style="text-align: center;">↘</td></tr> <tr><td>19:</td><td>*10.7</td><td style="text-align: center;">↘</td></tr> <tr><td>20:</td><td>10.5</td><td style="text-align: center;">↗</td></tr> <tr><td colspan="2">Serie</td><td style="text-align: right;">98.0</td></tr> <tr><td colspan="2">Total</td><td style="text-align: right;">195.0</td></tr> </table> | 11: | 10.1 | ↗ | 12: | 10.0 | ↘ | 13: | 10.1 | ↘ | 14: | 10.0 | ↗ | 15: | 10.0 | ↖ | 16: | 10.6 | ↗ | 17: | 10.1 | ↘ | 18: | 8.8 | ↘ | 19: | *10.7 | ↘ | 20: | 10.5 | ↗ | Serie | | 98.0 | Total | | 195.0 |
| 11: | 10.1 | ↗ | | | | | | | | | | | | | | | | | | | | | | | | | | | | | | | | | | | |
| 12: | 10.0 | ↘ | | | | | | | | | | | | | | | | | | | | | | | | | | | | | | | | | | | |
| 13: | 10.1 | ↘ | | | | | | | | | | | | | | | | | | | | | | | | | | | | | | | | | | | |
| 14: | 10.0 | ↗ | | | | | | | | | | | | | | | | | | | | | | | | | | | | | | | | | | | |
| 15: | 10.0 | ↖ | | | | | | | | | | | | | | | | | | | | | | | | | | | | | | | | | | | |
| 16: | 10.6 | ↗ | | | | | | | | | | | | | | | | | | | | | | | | | | | | | | | | | | | |
| 17: | 10.1 | ↘ | | | | | | | | | | | | | | | | | | | | | | | | | | | | | | | | | | | |
| 18: | 8.8 | ↘ | | | | | | | | | | | | | | | | | | | | | | | | | | | | | | | | | | | |
| 19: | *10.7 | ↘ | | | | | | | | | | | | | | | | | | | | | | | | | | | | | | | | | | | |
| 20: | 10.5 | ↗ | | | | | | | | | | | | | | | | | | | | | | | | | | | | | | | | | | | |
| Serie | | 98.0 | | | | | | | | | | | | | | | | | | | | | | | | | | | | | | | | | | | |
| Total | | 195.0 | | | | | | | | | | | | | | | | | | | | | | | | | | | | | | | | | | | |

| | | | | | | | | | | | | | | | | | | | | | | | | | | |
|---------------------|--|----|-----|---|----|------|---|----|-----|---|----|------|---|----|-----|---|----|------|---|----|------|---|-------|------|-------|-----|
| <p>Prøve</p> | <table style="width:100%; border-collapse: collapse;"> <tr><td style="width:10%;">1:</td><td style="width:15%;">8.9</td><td style="width:10%; text-align: right;">↗</td></tr> <tr><td>2:</td><td>10.4</td><td style="text-align: right;">↓</td></tr> <tr><td>3:</td><td>9.0</td><td style="text-align: right;">↘</td></tr> <tr><td>4:</td><td>10.1</td><td style="text-align: right;">←</td></tr> <tr><td>5:</td><td>9.6</td><td style="text-align: right;">↑</td></tr> <tr><td>6:</td><td>10.2</td><td style="text-align: right;">↙</td></tr> <tr><td>7:</td><td>10.2</td><td style="text-align: right;">↗</td></tr> </table> <table border="1" style="width:100%; border-collapse: collapse; margin-top: 5px;"> <tr> <td style="width:80%;">Serie</td> <td style="text-align: right;">66.0</td> </tr> <tr> <td>Total</td> <td style="text-align: right;">0.0</td> </tr> </table> | 1: | 8.9 | ↗ | 2: | 10.4 | ↓ | 3: | 9.0 | ↘ | 4: | 10.1 | ← | 5: | 9.6 | ↑ | 6: | 10.2 | ↙ | 7: | 10.2 | ↗ | Serie | 66.0 | Total | 0.0 |
| 1: | 8.9 | ↗ | | | | | | | | | | | | | | | | | | | | | | | | |
| 2: | 10.4 | ↓ | | | | | | | | | | | | | | | | | | | | | | | | |
| 3: | 9.0 | ↘ | | | | | | | | | | | | | | | | | | | | | | | | |
| 4: | 10.1 | ← | | | | | | | | | | | | | | | | | | | | | | | | |
| 5: | 9.6 | ↑ | | | | | | | | | | | | | | | | | | | | | | | | |
| 6: | 10.2 | ↙ | | | | | | | | | | | | | | | | | | | | | | | | |
| 7: | 10.2 | ↗ | | | | | | | | | | | | | | | | | | | | | | | | |
| Serie | 66.0 | | | | | | | | | | | | | | | | | | | | | | | | | |
| Total | 0.0 | | | | | | | | | | | | | | | | | | | | | | | | | |

| | | | | | | | | | | | | | | | | | | | | | | | | | | | | | | | | | | | |
|-----------------------|---|----|-----|---|----|-----|---|----|------|---|----|------|---|----|------|---|----|-----|---|----|-------|---|----|------|---|----|------|---|-----|-----|---|-------|------|-------|------|
| <p>20 Skud</p> | <table style="width:100%; border-collapse: collapse;"> <tr><td style="width:10%;">1:</td><td style="width:15%;">9.4</td><td style="width:10%; text-align: right;">←</td></tr> <tr><td>2:</td><td>9.3</td><td style="text-align: right;">↑</td></tr> <tr><td>3:</td><td>10.0</td><td style="text-align: right;">↘</td></tr> <tr><td>4:</td><td>10.1</td><td style="text-align: right;">↗</td></tr> <tr><td>5:</td><td>10.3</td><td style="text-align: right;">↗</td></tr> <tr><td>6:</td><td>7.3</td><td style="text-align: right;">→</td></tr> <tr><td>7:</td><td>*10.8</td><td style="text-align: right;">←</td></tr> <tr><td>8:</td><td>10.1</td><td style="text-align: right;">↓</td></tr> <tr><td>9:</td><td>10.4</td><td style="text-align: right;">↗</td></tr> <tr><td>10:</td><td>9.4</td><td style="text-align: right;">↗</td></tr> </table> <table border="1" style="width:100%; border-collapse: collapse; margin-top: 5px;"> <tr> <td style="width:80%;">Serie</td> <td style="text-align: right;">94.0</td> </tr> <tr> <td>Total</td> <td style="text-align: right;">94.0</td> </tr> </table> | 1: | 9.4 | ← | 2: | 9.3 | ↑ | 3: | 10.0 | ↘ | 4: | 10.1 | ↗ | 5: | 10.3 | ↗ | 6: | 7.3 | → | 7: | *10.8 | ← | 8: | 10.1 | ↓ | 9: | 10.4 | ↗ | 10: | 9.4 | ↗ | Serie | 94.0 | Total | 94.0 |
| 1: | 9.4 | ← | | | | | | | | | | | | | | | | | | | | | | | | | | | | | | | | | |
| 2: | 9.3 | ↑ | | | | | | | | | | | | | | | | | | | | | | | | | | | | | | | | | |
| 3: | 10.0 | ↘ | | | | | | | | | | | | | | | | | | | | | | | | | | | | | | | | | |
| 4: | 10.1 | ↗ | | | | | | | | | | | | | | | | | | | | | | | | | | | | | | | | | |
| 5: | 10.3 | ↗ | | | | | | | | | | | | | | | | | | | | | | | | | | | | | | | | | |
| 6: | 7.3 | → | | | | | | | | | | | | | | | | | | | | | | | | | | | | | | | | | |
| 7: | *10.8 | ← | | | | | | | | | | | | | | | | | | | | | | | | | | | | | | | | | |
| 8: | 10.1 | ↓ | | | | | | | | | | | | | | | | | | | | | | | | | | | | | | | | | |
| 9: | 10.4 | ↗ | | | | | | | | | | | | | | | | | | | | | | | | | | | | | | | | | |
| 10: | 9.4 | ↗ | | | | | | | | | | | | | | | | | | | | | | | | | | | | | | | | | |
| Serie | 94.0 | | | | | | | | | | | | | | | | | | | | | | | | | | | | | | | | | | |
| Total | 94.0 | | | | | | | | | | | | | | | | | | | | | | | | | | | | | | | | | | |

| | | | | | | | | | | | | | | | | | | | | | | | | | | | | | | | | | | | |
|-----------------------|--|-----|------|---|-----|-----|---|-----|-----|---|-----|-------|---|-----|-----|---|-----|-----|---|-----|-----|---|-----|------|---|-----|-----|---|-----|-----|---|-------|------|-------|-------|
| <p>20 Skud</p> | <table style="width:100%; border-collapse: collapse;"> <tr><td style="width:10%;">11:</td><td style="width:15%;">10.5</td><td style="width:10%; text-align: right;">↓</td></tr> <tr><td>12:</td><td>9.6</td><td style="text-align: right;">↙</td></tr> <tr><td>13:</td><td>8.8</td><td style="text-align: right;">↘</td></tr> <tr><td>14:</td><td>*10.7</td><td style="text-align: right;">←</td></tr> <tr><td>15:</td><td>9.0</td><td style="text-align: right;">↘</td></tr> <tr><td>16:</td><td>9.6</td><td style="text-align: right;">↗</td></tr> <tr><td>17:</td><td>9.3</td><td style="text-align: right;">→</td></tr> <tr><td>18:</td><td>10.3</td><td style="text-align: right;">→</td></tr> <tr><td>19:</td><td>9.9</td><td style="text-align: right;">↑</td></tr> <tr><td>20:</td><td>9.2</td><td style="text-align: right;">→</td></tr> </table> <table border="1" style="width:100%; border-collapse: collapse; margin-top: 5px;"> <tr> <td style="width:80%;">Serie</td> <td style="text-align: right;">92.0</td> </tr> <tr> <td>Total</td> <td style="text-align: right;">186.0</td> </tr> </table> | 11: | 10.5 | ↓ | 12: | 9.6 | ↙ | 13: | 8.8 | ↘ | 14: | *10.7 | ← | 15: | 9.0 | ↘ | 16: | 9.6 | ↗ | 17: | 9.3 | → | 18: | 10.3 | → | 19: | 9.9 | ↑ | 20: | 9.2 | → | Serie | 92.0 | Total | 186.0 |
| 11: | 10.5 | ↓ | | | | | | | | | | | | | | | | | | | | | | | | | | | | | | | | | |
| 12: | 9.6 | ↙ | | | | | | | | | | | | | | | | | | | | | | | | | | | | | | | | | |
| 13: | 8.8 | ↘ | | | | | | | | | | | | | | | | | | | | | | | | | | | | | | | | | |
| 14: | *10.7 | ← | | | | | | | | | | | | | | | | | | | | | | | | | | | | | | | | | |
| 15: | 9.0 | ↘ | | | | | | | | | | | | | | | | | | | | | | | | | | | | | | | | | |
| 16: | 9.6 | ↗ | | | | | | | | | | | | | | | | | | | | | | | | | | | | | | | | | |
| 17: | 9.3 | → | | | | | | | | | | | | | | | | | | | | | | | | | | | | | | | | | |
| 18: | 10.3 | → | | | | | | | | | | | | | | | | | | | | | | | | | | | | | | | | | |
| 19: | 9.9 | ↑ | | | | | | | | | | | | | | | | | | | | | | | | | | | | | | | | | |
| 20: | 9.2 | → | | | | | | | | | | | | | | | | | | | | | | | | | | | | | | | | | |
| Serie | 92.0 | | | | | | | | | | | | | | | | | | | | | | | | | | | | | | | | | | |
| Total | 186.0 | | | | | | | | | | | | | | | | | | | | | | | | | | | | | | | | | | |

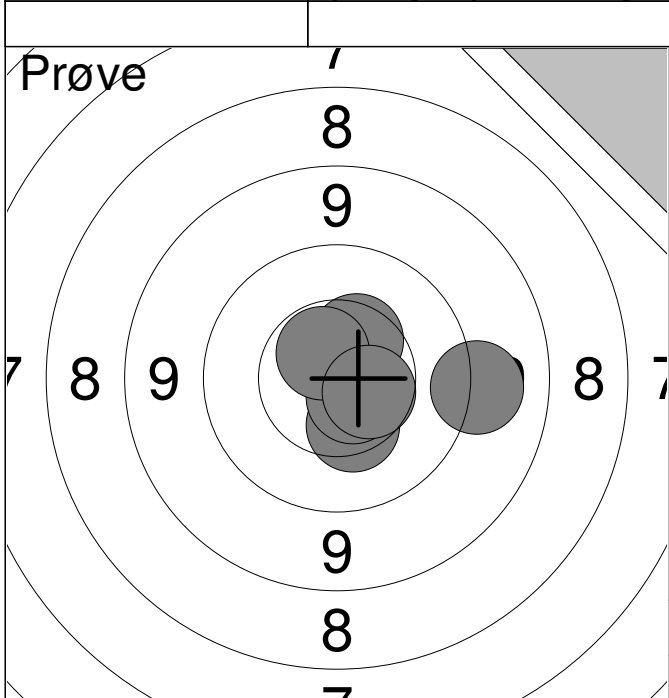

| | | |
|-------|-------|------|
| 1: | 10.5 | ↗ |
| 2: | 10.4 | ↘ |
| 3: | *10.7 | ↘ |
| 4: | *10.6 | ↗ |
| 5: | 10.5 | ↘ |
| 6: | 9.3 | → |
| <hr/> | | |
| Serie | | 59.0 |
| Total | | 0.0 |

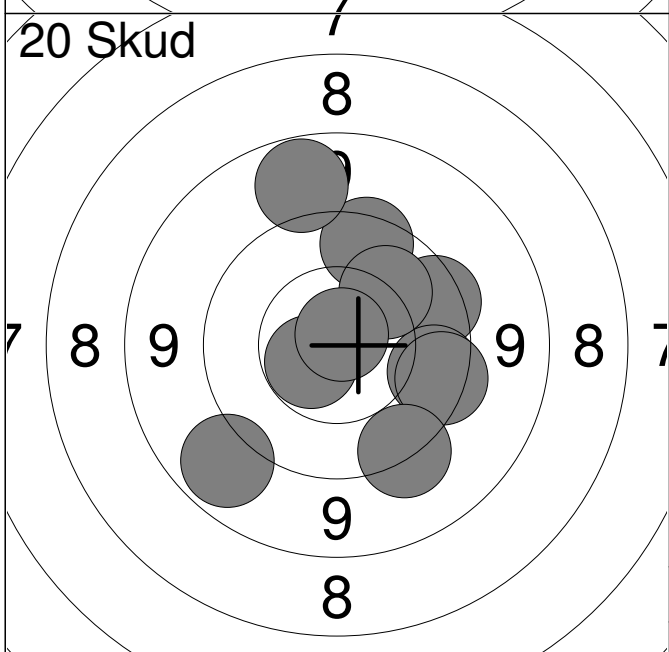

| | | |
|-------|-------|------|
| 1: | 9.7 | ↗ |
| 2: | 9.7 | → |
| 3: | 9.0 | ↗ |
| 4: | 9.8 | → |
| 5: | 9.7 | → |
| 6: | 9.4 | ↘ |
| 7: | *10.6 | ↖ |
| 8: | 10.1 | ↗ |
| 9: | 9.0 | ↖ |
| 10: | *10.8 | ↗ |
| <hr/> | | |
| Serie | | 93.0 |
| Total | | 93.0 |

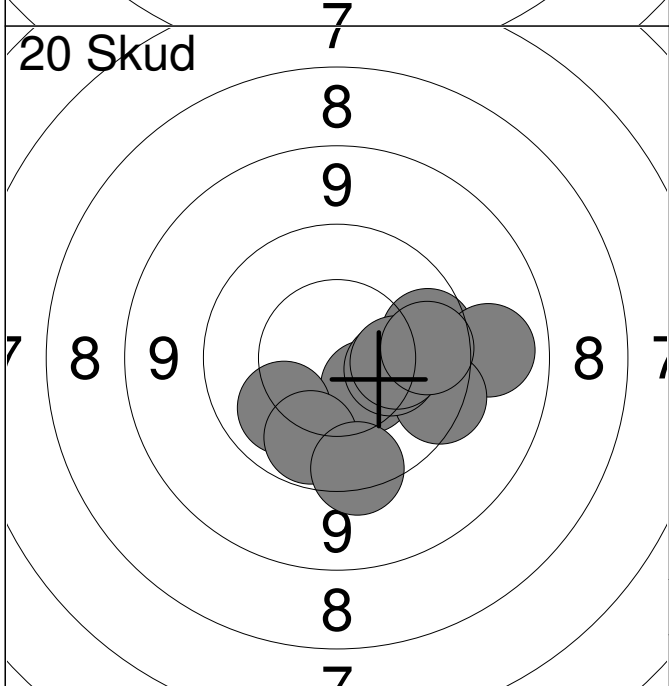

| | | |
|-------|------|-------|
| 11: | 9.9 | → |
| 12: | 10.5 | ↘ |
| 13: | 10.1 | ↖ |
| 14: | 9.1 | → |
| 15: | 10.0 | ↘ |
| 16: | 9.6 | ↘ |
| 17: | 10.3 | → |
| 18: | 9.6 | ↘ |
| 19: | 10.3 | → |
| 20: | 9.9 | → |
| <hr/> | | |
| Serie | | 95.0 |
| Total | | 188.0 |

| | | | | | | | | | | | | | | | | | | | | |
|---------------------|---|----|-----|---|----|------|---|----|-------|---|----|-----|---|----|-----|---|-------|------|-------|-----|
| <p>Prøve</p> | <table style="width:100%; border-collapse: collapse;"> <tr><td style="width:10%;">1:</td><td style="width:15%;">9.4</td><td style="width:10%; text-align: right;">→</td></tr> <tr><td>2:</td><td>10.1</td><td style="text-align: right;">↘</td></tr> <tr><td>3:</td><td>*10.7</td><td style="text-align: right;">↑</td></tr> <tr><td>4:</td><td>9.8</td><td style="text-align: right;">↘</td></tr> <tr><td>5:</td><td>9.9</td><td style="text-align: right;">↓</td></tr> </table> <table border="1" style="width:100%; border-collapse: collapse; margin-top: 5px;"> <tr> <td style="width:80%;">Serie</td> <td style="text-align: right;">47.0</td> </tr> <tr> <td>Total</td> <td style="text-align: right;">0.0</td> </tr> </table> | 1: | 9.4 | → | 2: | 10.1 | ↘ | 3: | *10.7 | ↑ | 4: | 9.8 | ↘ | 5: | 9.9 | ↓ | Serie | 47.0 | Total | 0.0 |
| 1: | 9.4 | → | | | | | | | | | | | | | | | | | | |
| 2: | 10.1 | ↘ | | | | | | | | | | | | | | | | | | |
| 3: | *10.7 | ↑ | | | | | | | | | | | | | | | | | | |
| 4: | 9.8 | ↘ | | | | | | | | | | | | | | | | | | |
| 5: | 9.9 | ↓ | | | | | | | | | | | | | | | | | | |
| Serie | 47.0 | | | | | | | | | | | | | | | | | | | |
| Total | 0.0 | | | | | | | | | | | | | | | | | | | |

| | | | | | | | | | | | | | | | | | | | | | | | | | | | | | | | | | | | |
|-----------------------|--|----|-----|---|----|-------|---|----|-----|---|----|------|---|----|-------|---|----|------|---|----|-------|---|----|-----|---|----|-----|---|-----|-----|---|-------|------|-------|------|
| <p>20 Skud</p> | <table style="width:100%; border-collapse: collapse;"> <tr><td style="width:10%;">1:</td><td style="width:15%;">9.8</td><td style="width:10%; text-align: right;">↘</td></tr> <tr><td>2:</td><td>*10.8</td><td style="text-align: right;">↘</td></tr> <tr><td>3:</td><td>9.9</td><td style="text-align: right;">↗</td></tr> <tr><td>4:</td><td>10.0</td><td style="text-align: right;">↘</td></tr> <tr><td>5:</td><td>*10.8</td><td style="text-align: right;">↘</td></tr> <tr><td>6:</td><td>10.3</td><td style="text-align: right;">↓</td></tr> <tr><td>7:</td><td>*10.9</td><td style="text-align: right;">↑</td></tr> <tr><td>8:</td><td>9.7</td><td style="text-align: right;">←</td></tr> <tr><td>9:</td><td>9.9</td><td style="text-align: right;">↗</td></tr> <tr><td>10:</td><td>9.0</td><td style="text-align: right;">↘</td></tr> </table> <table border="1" style="width:100%; border-collapse: collapse; margin-top: 5px;"> <tr> <td style="width:80%;">Serie</td> <td style="text-align: right;">95.0</td> </tr> <tr> <td>Total</td> <td style="text-align: right;">95.0</td> </tr> </table> | 1: | 9.8 | ↘ | 2: | *10.8 | ↘ | 3: | 9.9 | ↗ | 4: | 10.0 | ↘ | 5: | *10.8 | ↘ | 6: | 10.3 | ↓ | 7: | *10.9 | ↑ | 8: | 9.7 | ← | 9: | 9.9 | ↗ | 10: | 9.0 | ↘ | Serie | 95.0 | Total | 95.0 |
| 1: | 9.8 | ↘ | | | | | | | | | | | | | | | | | | | | | | | | | | | | | | | | | |
| 2: | *10.8 | ↘ | | | | | | | | | | | | | | | | | | | | | | | | | | | | | | | | | |
| 3: | 9.9 | ↗ | | | | | | | | | | | | | | | | | | | | | | | | | | | | | | | | | |
| 4: | 10.0 | ↘ | | | | | | | | | | | | | | | | | | | | | | | | | | | | | | | | | |
| 5: | *10.8 | ↘ | | | | | | | | | | | | | | | | | | | | | | | | | | | | | | | | | |
| 6: | 10.3 | ↓ | | | | | | | | | | | | | | | | | | | | | | | | | | | | | | | | | |
| 7: | *10.9 | ↑ | | | | | | | | | | | | | | | | | | | | | | | | | | | | | | | | | |
| 8: | 9.7 | ← | | | | | | | | | | | | | | | | | | | | | | | | | | | | | | | | | |
| 9: | 9.9 | ↗ | | | | | | | | | | | | | | | | | | | | | | | | | | | | | | | | | |
| 10: | 9.0 | ↘ | | | | | | | | | | | | | | | | | | | | | | | | | | | | | | | | | |
| Serie | 95.0 | | | | | | | | | | | | | | | | | | | | | | | | | | | | | | | | | | |
| Total | 95.0 | | | | | | | | | | | | | | | | | | | | | | | | | | | | | | | | | | |

| | | | | | | | | | | | | | | | | | | | | | | | | | | | | | | | | | | | |
|-----------------------|--|-----|-----|---|-----|-----|---|-----|------|---|-----|------|---|-----|-------|---|-----|------|---|-----|-----|---|-----|-------|---|-----|-----|---|-----|------|---|-------|------|-------|-------|
| <p>20 Skud</p> | <table style="width:100%; border-collapse: collapse;"> <tr><td style="width:10%;">11:</td><td style="width:15%;">9.8</td><td style="width:10%; text-align: right;">↘</td></tr> <tr><td>12:</td><td>9.8</td><td style="text-align: right;">↙</td></tr> <tr><td>13:</td><td>10.4</td><td style="text-align: right;">↗</td></tr> <tr><td>14:</td><td>10.3</td><td style="text-align: right;">↗</td></tr> <tr><td>15:</td><td>*10.6</td><td style="text-align: right;">↗</td></tr> <tr><td>16:</td><td>10.0</td><td style="text-align: right;">↙</td></tr> <tr><td>17:</td><td>9.9</td><td style="text-align: right;">→</td></tr> <tr><td>18:</td><td>*10.8</td><td style="text-align: right;">←</td></tr> <tr><td>19:</td><td>9.1</td><td style="text-align: right;">↗</td></tr> <tr><td>20:</td><td>10.0</td><td style="text-align: right;">→</td></tr> </table> <table border="1" style="width:100%; border-collapse: collapse; margin-top: 5px;"> <tr> <td style="width:80%;">Serie</td> <td style="text-align: right;">96.0</td> </tr> <tr> <td>Total</td> <td style="text-align: right;">191.0</td> </tr> </table> | 11: | 9.8 | ↘ | 12: | 9.8 | ↙ | 13: | 10.4 | ↗ | 14: | 10.3 | ↗ | 15: | *10.6 | ↗ | 16: | 10.0 | ↙ | 17: | 9.9 | → | 18: | *10.8 | ← | 19: | 9.1 | ↗ | 20: | 10.0 | → | Serie | 96.0 | Total | 191.0 |
| 11: | 9.8 | ↘ | | | | | | | | | | | | | | | | | | | | | | | | | | | | | | | | | |
| 12: | 9.8 | ↙ | | | | | | | | | | | | | | | | | | | | | | | | | | | | | | | | | |
| 13: | 10.4 | ↗ | | | | | | | | | | | | | | | | | | | | | | | | | | | | | | | | | |
| 14: | 10.3 | ↗ | | | | | | | | | | | | | | | | | | | | | | | | | | | | | | | | | |
| 15: | *10.6 | ↗ | | | | | | | | | | | | | | | | | | | | | | | | | | | | | | | | | |
| 16: | 10.0 | ↙ | | | | | | | | | | | | | | | | | | | | | | | | | | | | | | | | | |
| 17: | 9.9 | → | | | | | | | | | | | | | | | | | | | | | | | | | | | | | | | | | |
| 18: | *10.8 | ← | | | | | | | | | | | | | | | | | | | | | | | | | | | | | | | | | |
| 19: | 9.1 | ↗ | | | | | | | | | | | | | | | | | | | | | | | | | | | | | | | | | |
| 20: | 10.0 | → | | | | | | | | | | | | | | | | | | | | | | | | | | | | | | | | | |
| Serie | 96.0 | | | | | | | | | | | | | | | | | | | | | | | | | | | | | | | | | | |
| Total | 191.0 | | | | | | | | | | | | | | | | | | | | | | | | | | | | | | | | | | |

Hold
22

Skive
2

Anders Riisgaard

Vilsted Skf.

BK2

Prøve

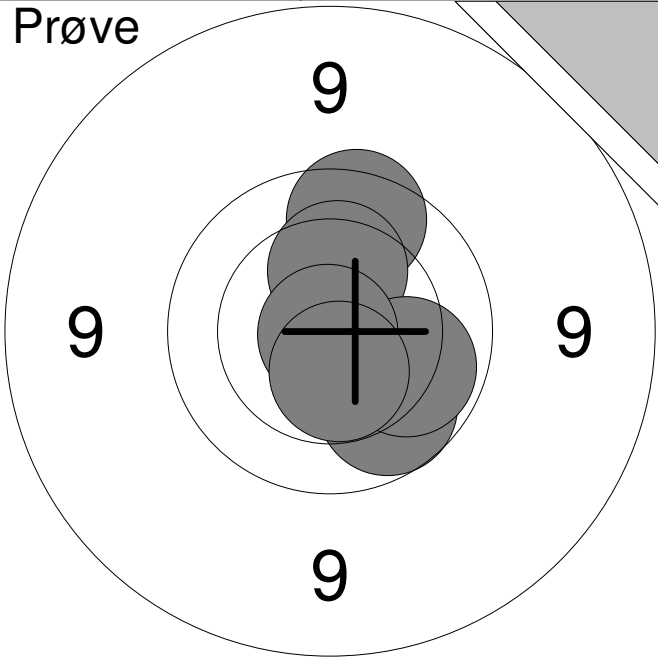

| | | |
|----|-------|---|
| 1: | 9.9 | ↘ |
| 2: | 9.8 | ↑ |
| 3: | 10.3 | ↑ |
| 4: | 10.0 | ↘ |
| 5: | *10.9 | ↙ |
| 6: | *10.5 | ↘ |

| | |
|-------|------|
| Serie | 58.0 |
| Total | 0.0 |

20 Skud

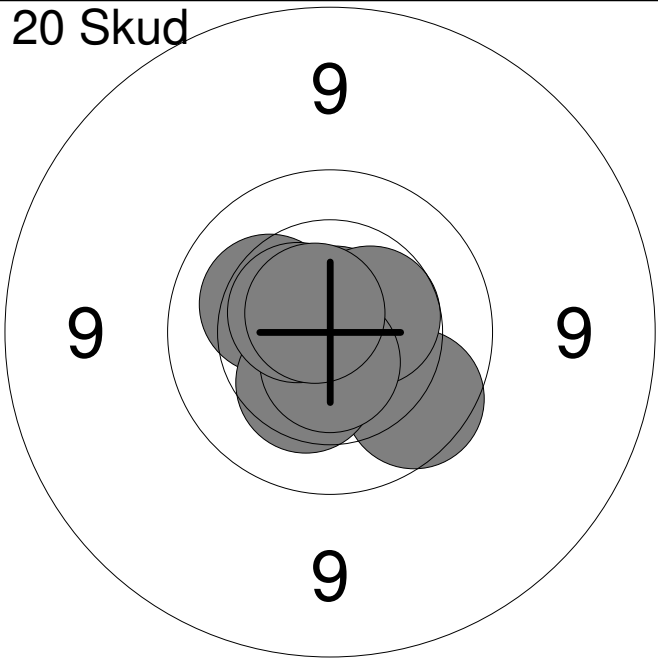

| | | |
|-----|-------|---|
| 1: | 10.2 | ↗ |
| 2: | *10.8 | ↑ |
| 3: | *10.6 | ↘ |
| 4: | 9.9 | ↘ |
| 5: | 10.3 | ↙ |
| 6: | *10.9 | ↘ |
| 7: | 10.5 | ↗ |
| 8: | *10.6 | ↘ |
| 9: | *10.5 | ↗ |
| 10: | *10.7 | ↗ |

| | |
|-------|------|
| Serie | 99.0 |
| Total | 99.0 |

20 Skud

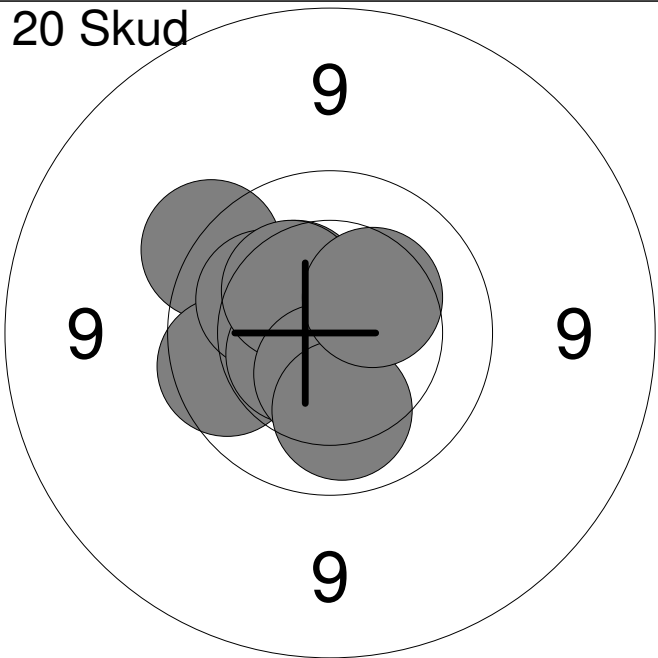

| | | |
|-----|-------|---|
| 11: | *10.8 | ← |
| 12: | 10.4 | ↗ |
| 13: | 9.6 | ↗ |
| 14: | 9.9 | ← |
| 15: | 10.2 | ↗ |
| 16: | *10.5 | ↙ |
| 17: | 10.3 | ↗ |
| 18: | *10.5 | ↘ |
| 19: | 10.1 | ↘ |
| 20: | 10.4 | ↗ |

| | |
|-------|-------|
| Serie | 98.0 |
| Total | 197.0 |

Hold
22

Skive
3

Simon Mejdahl

Vilsted Skf.

BK2

Prøve

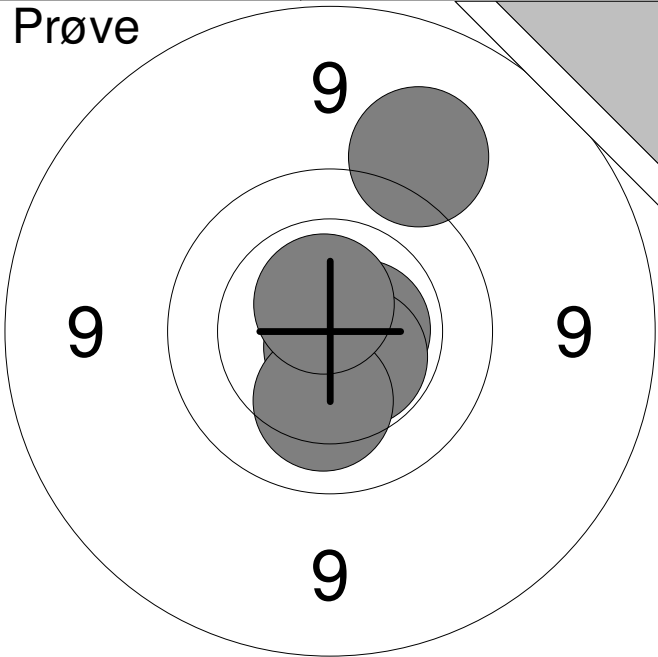

| | | |
|----|-------|---|
| 1: | 9.3 | ↗ |
| 2: | *10.6 | → |
| 3: | *10.8 | ↓ |
| 4: | *10.5 | ↘ |
| 5: | 10.2 | ↓ |
| 6: | *10.7 | ↑ |

| | |
|-------|------|
| Serie | 59.0 |
| Total | 0.0 |

20 Skud

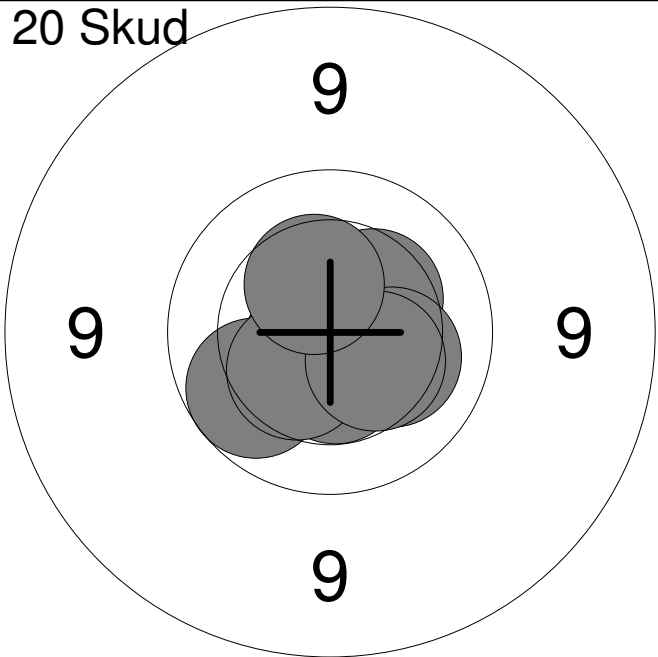

| | | |
|-----|-------|---|
| 1: | 10.4 | ↗ |
| 2: | *10.7 | ↙ |
| 3: | *10.5 | ↓ |
| 4: | 9.9 | ↙ |
| 5: | *10.9 | ↗ |
| 6: | *10.5 | ↓ |
| 7: | 10.2 | → |
| 8: | 10.4 | ↙ |
| 9: | 10.4 | ↘ |
| 10: | 10.4 | ↑ |

| | |
|-------|------|
| Serie | 99.0 |
| Total | 99.0 |

20 Skud

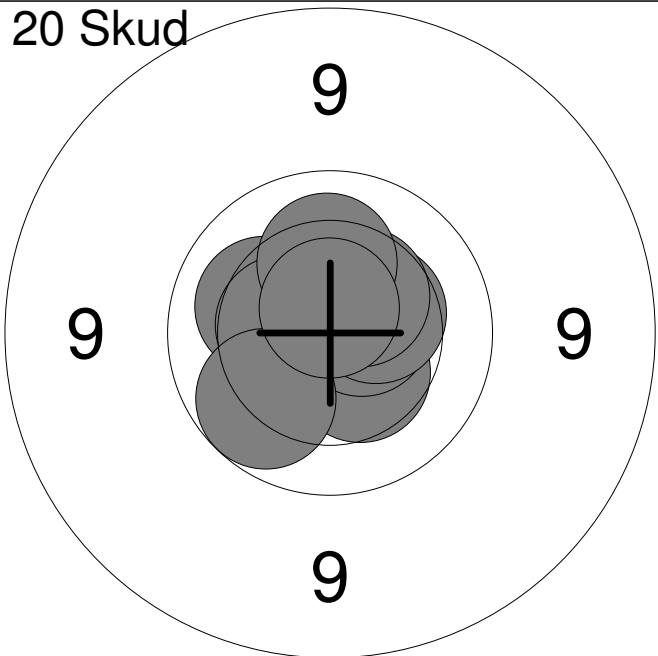

| | | |
|-----|-------|---|
| 11: | 10.2 | ↖ |
| 12: | *10.8 | ↓ |
| 13: | 10.4 | ↘ |
| 14: | 10.5 | ↖ |
| 15: | *10.6 | → |
| 16: | 10.0 | ↙ |
| 17: | 10.4 | → |
| 18: | 10.4 | ↗ |
| 19: | 10.2 | ↑ |
| 20: | *10.7 | ↑ |

| | |
|-------|-------|
| Serie | 100.0 |
| Total | 199.0 |

| | | | | | | | | | | | | | | | | | | | | | | | | | |
|---------------------|---|------|-----|---|----|------|---|----|------|---|----|-----|---|----|------|---|--|--|--|-------|--|------|-------|--|-----|
| <p>Prøve</p> | <table style="width:100%; border-collapse: collapse;"> <tr><td style="text-align: right;">1:</td><td style="text-align: right;">9.8</td><td style="text-align: right;">↑</td></tr> <tr><td style="text-align: right;">2:</td><td style="text-align: right;">10.4</td><td style="text-align: right;">↗</td></tr> <tr><td style="text-align: right;">3:</td><td style="text-align: right;">10.3</td><td style="text-align: right;">←</td></tr> <tr><td style="text-align: right;">4:</td><td style="text-align: right;">9.1</td><td style="text-align: right;">←</td></tr> <tr><td style="text-align: right;">5:</td><td style="text-align: right;">10.3</td><td style="text-align: right;">→</td></tr> <tr><td colspan="3"> </td></tr> <tr><td colspan="2">Serie</td><td style="text-align: right;">48.0</td></tr> <tr><td colspan="2">Total</td><td style="text-align: right;">0.0</td></tr> </table> | 1: | 9.8 | ↑ | 2: | 10.4 | ↗ | 3: | 10.3 | ← | 4: | 9.1 | ← | 5: | 10.3 | → | | | | Serie | | 48.0 | Total | | 0.0 |
| 1: | 9.8 | ↑ | | | | | | | | | | | | | | | | | | | | | | | |
| 2: | 10.4 | ↗ | | | | | | | | | | | | | | | | | | | | | | | |
| 3: | 10.3 | ← | | | | | | | | | | | | | | | | | | | | | | | |
| 4: | 9.1 | ← | | | | | | | | | | | | | | | | | | | | | | | |
| 5: | 10.3 | → | | | | | | | | | | | | | | | | | | | | | | | |
| | | | | | | | | | | | | | | | | | | | | | | | | | |
| Serie | | 48.0 | | | | | | | | | | | | | | | | | | | | | | | |
| Total | | 0.0 | | | | | | | | | | | | | | | | | | | | | | | |

| | | | | | | | | | | | | | | | | | | | | | | | | | | | | | | | | | | | | | | | | |
|-----------------------|--|------|-----|---|----|-----|---|----|-------|---|----|-----|---|----|-----|---|----|-----|---|----|-----|---|----|-----|---|----|-----|---|-----|-----|---|--|--|--|-------|--|------|-------|--|------|
| <p>20 Skud</p> | <table style="width:100%; border-collapse: collapse;"> <tr><td style="text-align: right;">1:</td><td style="text-align: right;">9.6</td><td style="text-align: right;">↘</td></tr> <tr><td style="text-align: right;">2:</td><td style="text-align: right;">9.5</td><td style="text-align: right;">↘</td></tr> <tr><td style="text-align: right;">3:</td><td style="text-align: right;">*10.6</td><td style="text-align: right;">←</td></tr> <tr><td style="text-align: right;">4:</td><td style="text-align: right;">9.9</td><td style="text-align: right;">←</td></tr> <tr><td style="text-align: right;">5:</td><td style="text-align: right;">9.8</td><td style="text-align: right;">↗</td></tr> <tr><td style="text-align: right;">6:</td><td style="text-align: right;">9.7</td><td style="text-align: right;">↗</td></tr> <tr><td style="text-align: right;">7:</td><td style="text-align: right;">9.7</td><td style="text-align: right;">↗</td></tr> <tr><td style="text-align: right;">8:</td><td style="text-align: right;">9.7</td><td style="text-align: right;">→</td></tr> <tr><td style="text-align: right;">9:</td><td style="text-align: right;">9.6</td><td style="text-align: right;">↗</td></tr> <tr><td style="text-align: right;">10:</td><td style="text-align: right;">9.8</td><td style="text-align: right;">↘</td></tr> <tr><td colspan="3"> </td></tr> <tr><td colspan="2">Serie</td><td style="text-align: right;">91.0</td></tr> <tr><td colspan="2">Total</td><td style="text-align: right;">91.0</td></tr> </table> | 1: | 9.6 | ↘ | 2: | 9.5 | ↘ | 3: | *10.6 | ← | 4: | 9.9 | ← | 5: | 9.8 | ↗ | 6: | 9.7 | ↗ | 7: | 9.7 | ↗ | 8: | 9.7 | → | 9: | 9.6 | ↗ | 10: | 9.8 | ↘ | | | | Serie | | 91.0 | Total | | 91.0 |
| 1: | 9.6 | ↘ | | | | | | | | | | | | | | | | | | | | | | | | | | | | | | | | | | | | | | |
| 2: | 9.5 | ↘ | | | | | | | | | | | | | | | | | | | | | | | | | | | | | | | | | | | | | | |
| 3: | *10.6 | ← | | | | | | | | | | | | | | | | | | | | | | | | | | | | | | | | | | | | | | |
| 4: | 9.9 | ← | | | | | | | | | | | | | | | | | | | | | | | | | | | | | | | | | | | | | | |
| 5: | 9.8 | ↗ | | | | | | | | | | | | | | | | | | | | | | | | | | | | | | | | | | | | | | |
| 6: | 9.7 | ↗ | | | | | | | | | | | | | | | | | | | | | | | | | | | | | | | | | | | | | | |
| 7: | 9.7 | ↗ | | | | | | | | | | | | | | | | | | | | | | | | | | | | | | | | | | | | | | |
| 8: | 9.7 | → | | | | | | | | | | | | | | | | | | | | | | | | | | | | | | | | | | | | | | |
| 9: | 9.6 | ↗ | | | | | | | | | | | | | | | | | | | | | | | | | | | | | | | | | | | | | | |
| 10: | 9.8 | ↘ | | | | | | | | | | | | | | | | | | | | | | | | | | | | | | | | | | | | | | |
| | | | | | | | | | | | | | | | | | | | | | | | | | | | | | | | | | | | | | | | | |
| Serie | | 91.0 | | | | | | | | | | | | | | | | | | | | | | | | | | | | | | | | | | | | | | |
| Total | | 91.0 | | | | | | | | | | | | | | | | | | | | | | | | | | | | | | | | | | | | | | |

| | | | | | | | | | | | | | | | | | | | | | | | | | | | | | | | | | | | | | | | | |
|-----------------------|---|-------|-----|---|-----|-----|---|-----|-------|---|-----|-----|---|-----|------|---|-----|-----|---|-----|-----|---|-----|-----|---|-----|-----|---|-----|-------|---|--|--|--|-------|--|------|-------|--|-------|
| <p>20 Skud</p> | <table style="width:100%; border-collapse: collapse;"> <tr><td style="text-align: right;">11:</td><td style="text-align: right;">9.8</td><td style="text-align: right;">→</td></tr> <tr><td style="text-align: right;">12:</td><td style="text-align: right;">9.1</td><td style="text-align: right;">↗</td></tr> <tr><td style="text-align: right;">13:</td><td style="text-align: right;">*10.7</td><td style="text-align: right;">↗</td></tr> <tr><td style="text-align: right;">14:</td><td style="text-align: right;">9.7</td><td style="text-align: right;">→</td></tr> <tr><td style="text-align: right;">15:</td><td style="text-align: right;">10.0</td><td style="text-align: right;">→</td></tr> <tr><td style="text-align: right;">16:</td><td style="text-align: right;">9.8</td><td style="text-align: right;">↗</td></tr> <tr><td style="text-align: right;">17:</td><td style="text-align: right;">9.9</td><td style="text-align: right;">↗</td></tr> <tr><td style="text-align: right;">18:</td><td style="text-align: right;">9.4</td><td style="text-align: right;">↗</td></tr> <tr><td style="text-align: right;">19:</td><td style="text-align: right;">9.5</td><td style="text-align: right;">↗</td></tr> <tr><td style="text-align: right;">20:</td><td style="text-align: right;">*10.8</td><td style="text-align: right;">←</td></tr> <tr><td colspan="3"> </td></tr> <tr><td colspan="2">Serie</td><td style="text-align: right;">93.0</td></tr> <tr><td colspan="2">Total</td><td style="text-align: right;">184.0</td></tr> </table> | 11: | 9.8 | → | 12: | 9.1 | ↗ | 13: | *10.7 | ↗ | 14: | 9.7 | → | 15: | 10.0 | → | 16: | 9.8 | ↗ | 17: | 9.9 | ↗ | 18: | 9.4 | ↗ | 19: | 9.5 | ↗ | 20: | *10.8 | ← | | | | Serie | | 93.0 | Total | | 184.0 |
| 11: | 9.8 | → | | | | | | | | | | | | | | | | | | | | | | | | | | | | | | | | | | | | | | |
| 12: | 9.1 | ↗ | | | | | | | | | | | | | | | | | | | | | | | | | | | | | | | | | | | | | | |
| 13: | *10.7 | ↗ | | | | | | | | | | | | | | | | | | | | | | | | | | | | | | | | | | | | | | |
| 14: | 9.7 | → | | | | | | | | | | | | | | | | | | | | | | | | | | | | | | | | | | | | | | |
| 15: | 10.0 | → | | | | | | | | | | | | | | | | | | | | | | | | | | | | | | | | | | | | | | |
| 16: | 9.8 | ↗ | | | | | | | | | | | | | | | | | | | | | | | | | | | | | | | | | | | | | | |
| 17: | 9.9 | ↗ | | | | | | | | | | | | | | | | | | | | | | | | | | | | | | | | | | | | | | |
| 18: | 9.4 | ↗ | | | | | | | | | | | | | | | | | | | | | | | | | | | | | | | | | | | | | | |
| 19: | 9.5 | ↗ | | | | | | | | | | | | | | | | | | | | | | | | | | | | | | | | | | | | | | |
| 20: | *10.8 | ← | | | | | | | | | | | | | | | | | | | | | | | | | | | | | | | | | | | | | | |
| | | | | | | | | | | | | | | | | | | | | | | | | | | | | | | | | | | | | | | | | |
| Serie | | 93.0 | | | | | | | | | | | | | | | | | | | | | | | | | | | | | | | | | | | | | | |
| Total | | 184.0 | | | | | | | | | | | | | | | | | | | | | | | | | | | | | | | | | | | | | | |

| | | | | | | | | | | | | | | | | | |
|---------------------|---|----|------|---|----|------|---|----|-------|---|----|-------|---|-------|------|-------|-----|
| <p>Prøve</p> | <table style="width:100%; border-collapse: collapse;"> <tr><td style="width:10%;">1:</td><td style="width:15%;">10.0</td><td style="width:10%; text-align: right;">↙</td></tr> <tr><td>2:</td><td>10.5</td><td style="text-align: right;">←</td></tr> <tr><td>3:</td><td>*10.7</td><td style="text-align: right;">↓</td></tr> <tr><td>4:</td><td>*10.8</td><td style="text-align: right;">↙</td></tr> </table> <table border="1" style="width:100%; border-collapse: collapse; margin-top: 10px;"> <tr> <td style="width:80%;">Serie</td> <td style="text-align: right;">40.0</td> </tr> <tr> <td>Total</td> <td style="text-align: right;">0.0</td> </tr> </table> | 1: | 10.0 | ↙ | 2: | 10.5 | ← | 3: | *10.7 | ↓ | 4: | *10.8 | ↙ | Serie | 40.0 | Total | 0.0 |
| 1: | 10.0 | ↙ | | | | | | | | | | | | | | | |
| 2: | 10.5 | ← | | | | | | | | | | | | | | | |
| 3: | *10.7 | ↓ | | | | | | | | | | | | | | | |
| 4: | *10.8 | ↙ | | | | | | | | | | | | | | | |
| Serie | 40.0 | | | | | | | | | | | | | | | | |
| Total | 0.0 | | | | | | | | | | | | | | | | |

| | | | | | | | | | | | | | | | | | | | | | | | | | | | | | | | | | | | |
|-----------------------|--|----|-------|---|----|-------|---|----|-----|---|----|-------|---|----|-------|---|----|------|---|----|-------|---|----|-------|---|----|------|---|-----|------|---|-------|------|-------|------|
| <p>20 Skud</p> | <table style="width:100%; border-collapse: collapse;"> <tr><td style="width:10%;">1:</td><td style="width:15%;">*10.5</td><td style="width:10%; text-align: right;">↙</td></tr> <tr><td>2:</td><td>*10.5</td><td style="text-align: right;">→</td></tr> <tr><td>3:</td><td>9.9</td><td style="text-align: right;">→</td></tr> <tr><td>4:</td><td>*10.9</td><td style="text-align: right;">↗</td></tr> <tr><td>5:</td><td>*10.9</td><td style="text-align: right;">↙</td></tr> <tr><td>6:</td><td>10.0</td><td style="text-align: right;">←</td></tr> <tr><td>7:</td><td>*10.6</td><td style="text-align: right;">↗</td></tr> <tr><td>8:</td><td>*10.5</td><td style="text-align: right;">→</td></tr> <tr><td>9:</td><td>10.3</td><td style="text-align: right;">↗</td></tr> <tr><td>10:</td><td>10.5</td><td style="text-align: right;">↓</td></tr> </table> <table border="1" style="width:100%; border-collapse: collapse; margin-top: 10px;"> <tr> <td style="width:80%;">Serie</td> <td style="text-align: right;">99.0</td> </tr> <tr> <td>Total</td> <td style="text-align: right;">99.0</td> </tr> </table> | 1: | *10.5 | ↙ | 2: | *10.5 | → | 3: | 9.9 | → | 4: | *10.9 | ↗ | 5: | *10.9 | ↙ | 6: | 10.0 | ← | 7: | *10.6 | ↗ | 8: | *10.5 | → | 9: | 10.3 | ↗ | 10: | 10.5 | ↓ | Serie | 99.0 | Total | 99.0 |
| 1: | *10.5 | ↙ | | | | | | | | | | | | | | | | | | | | | | | | | | | | | | | | | |
| 2: | *10.5 | → | | | | | | | | | | | | | | | | | | | | | | | | | | | | | | | | | |
| 3: | 9.9 | → | | | | | | | | | | | | | | | | | | | | | | | | | | | | | | | | | |
| 4: | *10.9 | ↗ | | | | | | | | | | | | | | | | | | | | | | | | | | | | | | | | | |
| 5: | *10.9 | ↙ | | | | | | | | | | | | | | | | | | | | | | | | | | | | | | | | | |
| 6: | 10.0 | ← | | | | | | | | | | | | | | | | | | | | | | | | | | | | | | | | | |
| 7: | *10.6 | ↗ | | | | | | | | | | | | | | | | | | | | | | | | | | | | | | | | | |
| 8: | *10.5 | → | | | | | | | | | | | | | | | | | | | | | | | | | | | | | | | | | |
| 9: | 10.3 | ↗ | | | | | | | | | | | | | | | | | | | | | | | | | | | | | | | | | |
| 10: | 10.5 | ↓ | | | | | | | | | | | | | | | | | | | | | | | | | | | | | | | | | |
| Serie | 99.0 | | | | | | | | | | | | | | | | | | | | | | | | | | | | | | | | | | |
| Total | 99.0 | | | | | | | | | | | | | | | | | | | | | | | | | | | | | | | | | | |

| | | | | | | | | | | | | | | | | | | | | | | | | | | | | | | | | | | | |
|-----------------------|--|-----|-------|---|-----|------|---|-----|------|---|-----|-------|---|-----|-------|---|-----|-------|---|-----|------|---|-----|------|---|-----|-------|---|-----|-------|---|-------|-------|-------|-------|
| <p>20 Skud</p> | <table style="width:100%; border-collapse: collapse;"> <tr><td style="width:10%;">11:</td><td style="width:15%;">*10.7</td><td style="width:10%; text-align: right;">↓</td></tr> <tr><td>12:</td><td>10.3</td><td style="text-align: right;">↙</td></tr> <tr><td>13:</td><td>10.5</td><td style="text-align: right;">→</td></tr> <tr><td>14:</td><td>*10.6</td><td style="text-align: right;">→</td></tr> <tr><td>15:</td><td>*10.5</td><td style="text-align: right;">↙</td></tr> <tr><td>16:</td><td>*10.6</td><td style="text-align: right;">↗</td></tr> <tr><td>17:</td><td>10.5</td><td style="text-align: right;">↗</td></tr> <tr><td>18:</td><td>10.3</td><td style="text-align: right;">↘</td></tr> <tr><td>19:</td><td>*10.6</td><td style="text-align: right;">↓</td></tr> <tr><td>20:</td><td>*10.8</td><td style="text-align: right;">↓</td></tr> </table> <table border="1" style="width:100%; border-collapse: collapse; margin-top: 10px;"> <tr> <td style="width:80%;">Serie</td> <td style="text-align: right;">100.0</td> </tr> <tr> <td>Total</td> <td style="text-align: right;">199.0</td> </tr> </table> | 11: | *10.7 | ↓ | 12: | 10.3 | ↙ | 13: | 10.5 | → | 14: | *10.6 | → | 15: | *10.5 | ↙ | 16: | *10.6 | ↗ | 17: | 10.5 | ↗ | 18: | 10.3 | ↘ | 19: | *10.6 | ↓ | 20: | *10.8 | ↓ | Serie | 100.0 | Total | 199.0 |
| 11: | *10.7 | ↓ | | | | | | | | | | | | | | | | | | | | | | | | | | | | | | | | | |
| 12: | 10.3 | ↙ | | | | | | | | | | | | | | | | | | | | | | | | | | | | | | | | | |
| 13: | 10.5 | → | | | | | | | | | | | | | | | | | | | | | | | | | | | | | | | | | |
| 14: | *10.6 | → | | | | | | | | | | | | | | | | | | | | | | | | | | | | | | | | | |
| 15: | *10.5 | ↙ | | | | | | | | | | | | | | | | | | | | | | | | | | | | | | | | | |
| 16: | *10.6 | ↗ | | | | | | | | | | | | | | | | | | | | | | | | | | | | | | | | | |
| 17: | 10.5 | ↗ | | | | | | | | | | | | | | | | | | | | | | | | | | | | | | | | | |
| 18: | 10.3 | ↘ | | | | | | | | | | | | | | | | | | | | | | | | | | | | | | | | | |
| 19: | *10.6 | ↓ | | | | | | | | | | | | | | | | | | | | | | | | | | | | | | | | | |
| 20: | *10.8 | ↓ | | | | | | | | | | | | | | | | | | | | | | | | | | | | | | | | | |
| Serie | 100.0 | | | | | | | | | | | | | | | | | | | | | | | | | | | | | | | | | | |
| Total | 199.0 | | | | | | | | | | | | | | | | | | | | | | | | | | | | | | | | | | |

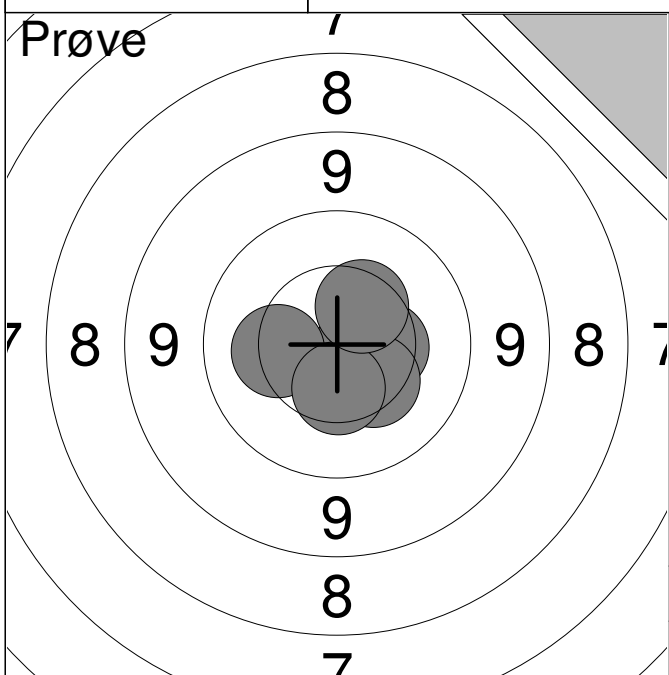

| | | |
|--------------|-------|------|
| 1: | *10.7 | ↘ |
| 2: | 10.4 | → |
| 3: | 10.4 | ↘ |
| 4: | 10.3 | ← |
| 5: | 10.4 | ↓ |
| 6: | 10.4 | ↗ |
| Serie | | 60.0 |
| Total | | 0.0 |

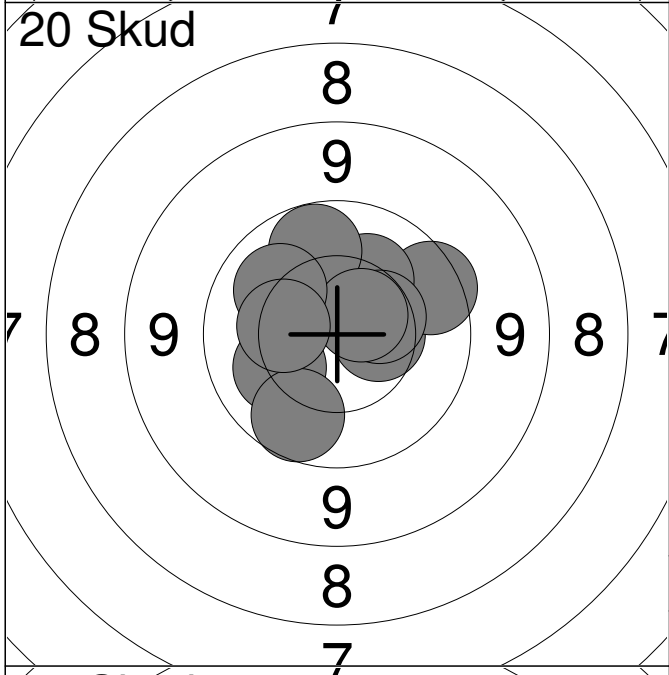

| | | |
|--------------|-------|------|
| 1: | 10.2 | ↙ |
| 2: | 10.5 | → |
| 3: | 9.7 | ↗ |
| 4: | 10.2 | ↗ |
| 5: | 10.0 | ↑ |
| 6: | 9.9 | ↘ |
| 7: | 10.4 | → |
| 8: | *10.6 | ↗ |
| 9: | 10.1 | ↗ |
| 10: | 10.3 | ← |
| Serie | | 98.0 |
| Total | | 98.0 |

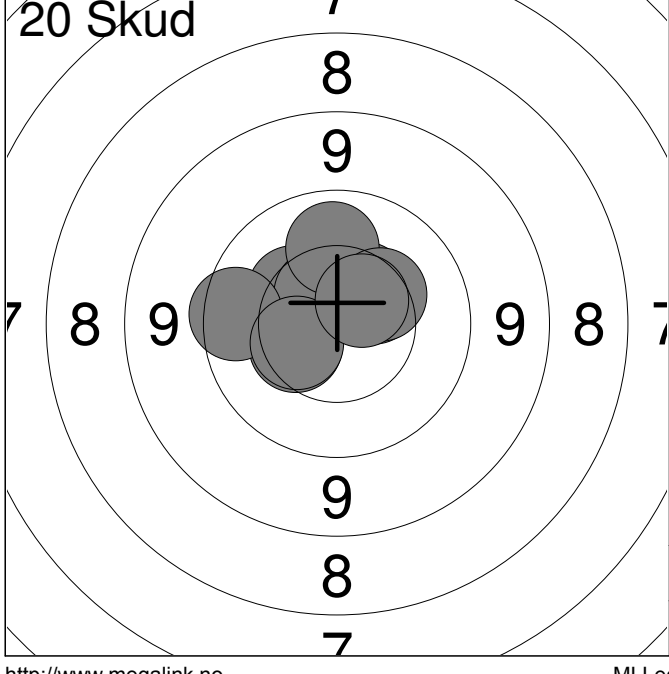

| | | |
|--------------|------|-------|
| 11: | 10.3 | ↙ |
| 12: | 10.4 | ↙ |
| 13: | 10.4 | ↗ |
| 14: | 10.6 | ↑ |
| 15: | 10.4 | ↗ |
| 16: | 9.8 | ← |
| 17: | 10.4 | ↙ |
| 18: | 10.1 | ↑ |
| 19: | 10.4 | ↗ |
| 20: | 10.6 | ↗ |
| Serie | | 99.0 |
| Total | | 197.0 |

Hold
22

Skive
7

Emma Myrup Langgaard

Løgstør Skyttelaug

MB2

Prøve

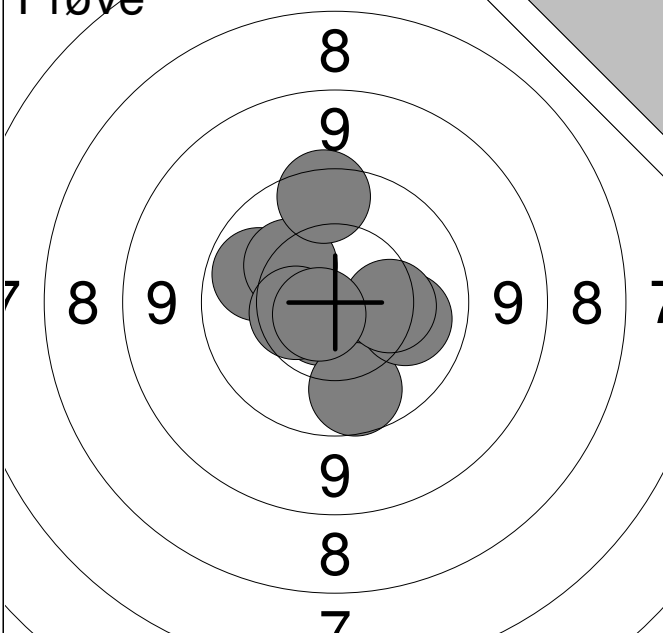

| | | |
|----|-------|---|
| 1: | 10.0 | ↖ |
| 2: | *10.7 | ↙ |
| 3: | 9.9 | ↘ |
| 4: | 10.3 | ↗ |
| 5: | 10.1 | → |
| 6: | 10.5 | ← |
| 7: | 9.7 | ↑ |
| 8: | 10.3 | → |
| 9: | *10.7 | ↙ |

| | |
|-------|------|
| Serie | 88.0 |
| Total | 0.0 |

20 Skud

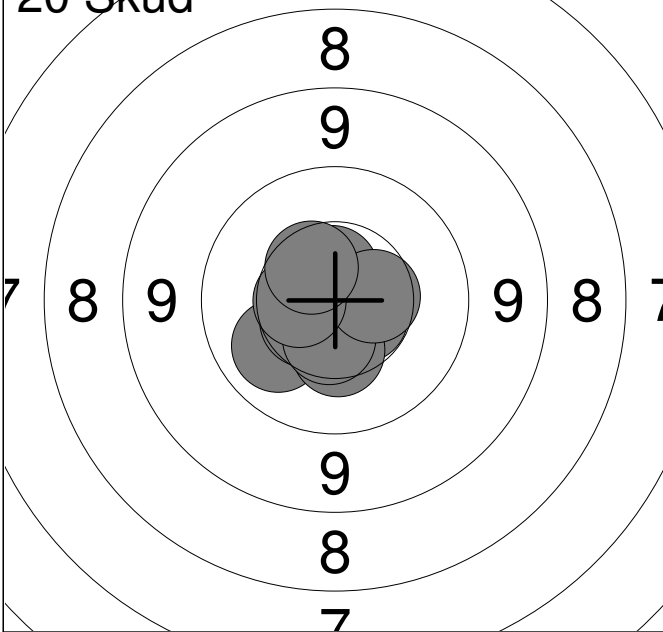

| | | |
|-----|-------|---|
| 1: | *10.6 | ← |
| 2: | *10.6 | ↘ |
| 3: | *10.6 | ↑ |
| 4: | 10.1 | ↙ |
| 5: | 10.4 | ↘ |
| 6: | 10.5 | ↙ |
| 7: | 10.5 | ↘ |
| 8: | 10.5 | → |
| 9: | 10.5 | ← |
| 10: | 10.5 | ↗ |

| | |
|-------|-------|
| Serie | 100.0 |
| Total | 100.0 |

20 Skud

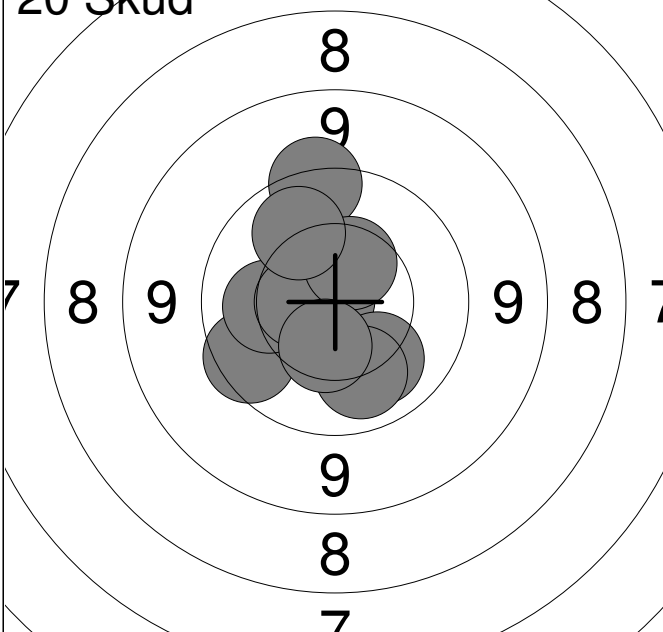

| | | |
|-----|-------|---|
| 11: | *10.9 | ← |
| 12: | 9.8 | ↙ |
| 13: | 10.2 | ← |
| 14: | 10.1 | ↘ |
| 15: | 10.6 | ← |
| 16: | 10.1 | ↘ |
| 17: | 9.5 | ↑ |
| 18: | 10.5 | ↗ |
| 19: | 10.4 | ↘ |
| 20: | 10.0 | ↗ |

| | |
|-------|-------|
| Serie | 98.0 |
| Total | 198.0 |

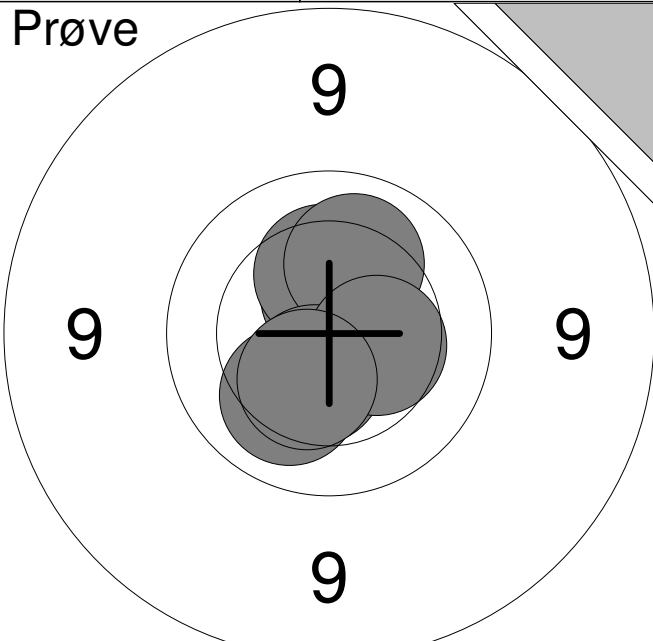
| | | | | | | | | | | | | | | | | | | | | | | | | | | | | |
|--|---|-------------|-------|---|----|------|---|----|------|---|----|------|---|----|------|---|----|------|---|----|------|---|--------------|--|-------------|--------------|--|------------|
| <p>Prøve</p>  | <table style="width:100%; border-collapse: collapse;"> <tr><td style="width:10%;">1:</td><td style="width:15%;">*10.5</td><td style="width:10%; text-align: right;">↑</td></tr> <tr><td>2:</td><td>10.3</td><td style="text-align: right;">↑</td></tr> <tr><td>3:</td><td>10.2</td><td style="text-align: right;">↑</td></tr> <tr><td>4:</td><td>10.5</td><td style="text-align: right;">↓</td></tr> <tr><td>5:</td><td>10.4</td><td style="text-align: right;">→</td></tr> <tr><td>6:</td><td>10.2</td><td style="text-align: right;">↙</td></tr> <tr><td>7:</td><td>10.4</td><td style="text-align: right;">↙</td></tr> <tr><td colspan="2">Serie</td><td style="text-align: right;">70.0</td></tr> <tr><td colspan="2">Total</td><td style="text-align: right;">0.0</td></tr> </table> | 1: | *10.5 | ↑ | 2: | 10.3 | ↑ | 3: | 10.2 | ↑ | 4: | 10.5 | ↓ | 5: | 10.4 | → | 6: | 10.2 | ↙ | 7: | 10.4 | ↙ | Serie | | 70.0 | Total | | 0.0 |
| 1: | *10.5 | ↑ | | | | | | | | | | | | | | | | | | | | | | | | | | |
| 2: | 10.3 | ↑ | | | | | | | | | | | | | | | | | | | | | | | | | | |
| 3: | 10.2 | ↑ | | | | | | | | | | | | | | | | | | | | | | | | | | |
| 4: | 10.5 | ↓ | | | | | | | | | | | | | | | | | | | | | | | | | | |
| 5: | 10.4 | → | | | | | | | | | | | | | | | | | | | | | | | | | | |
| 6: | 10.2 | ↙ | | | | | | | | | | | | | | | | | | | | | | | | | | |
| 7: | 10.4 | ↙ | | | | | | | | | | | | | | | | | | | | | | | | | | |
| Serie | | 70.0 | | | | | | | | | | | | | | | | | | | | | | | | | | |
| Total | | 0.0 | | | | | | | | | | | | | | | | | | | | | | | | | | |

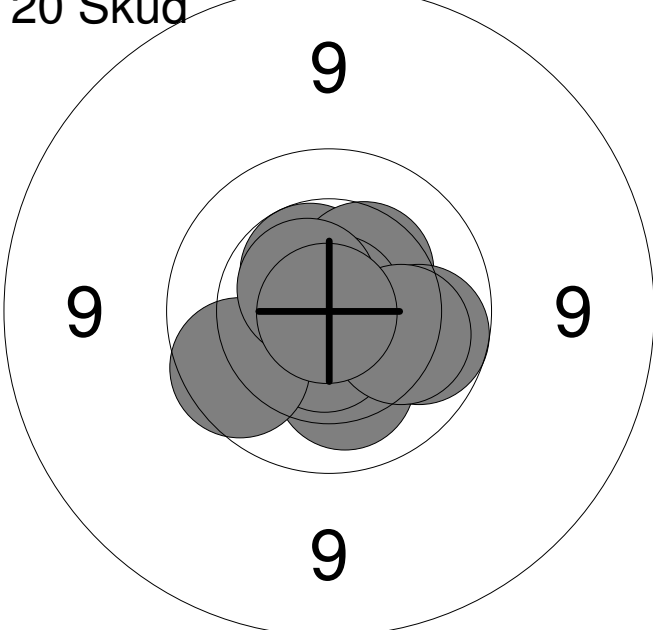
| | | | | | | | | | | | | | | | | | | | | | | | | | | | | | | | | | | | | | |
|---|---|-------------|------|---|----|------|---|----|------|---|----|-------|---|----|-------|---|----|-----|---|----|-----|---|----|-------|---|----|------|---|-----|-------|---|--------------|--|-------------|--------------|--|-------------|
| <p>20 Skud</p>  | <table style="width:100%; border-collapse: collapse;"> <tr><td style="width:10%;">1:</td><td style="width:15%;">10.5</td><td style="width:10%; text-align: right;">↖</td></tr> <tr><td>2:</td><td>10.2</td><td style="text-align: right;">↓</td></tr> <tr><td>3:</td><td>10.4</td><td style="text-align: right;">↗</td></tr> <tr><td>4:</td><td>*10.6</td><td style="text-align: right;">↓</td></tr> <tr><td>5:</td><td>*10.9</td><td style="text-align: right;">↗</td></tr> <tr><td>6:</td><td>9.9</td><td style="text-align: right;">→</td></tr> <tr><td>7:</td><td>9.9</td><td style="text-align: right;">↖</td></tr> <tr><td>8:</td><td>*10.6</td><td style="text-align: right;">↗</td></tr> <tr><td>9:</td><td>10.1</td><td style="text-align: right;">→</td></tr> <tr><td>10:</td><td>*10.9</td><td style="text-align: right;">↙</td></tr> <tr><td colspan="2">Serie</td><td style="text-align: right;">98.0</td></tr> <tr><td colspan="2">Total</td><td style="text-align: right;">98.0</td></tr> </table> | 1: | 10.5 | ↖ | 2: | 10.2 | ↓ | 3: | 10.4 | ↗ | 4: | *10.6 | ↓ | 5: | *10.9 | ↗ | 6: | 9.9 | → | 7: | 9.9 | ↖ | 8: | *10.6 | ↗ | 9: | 10.1 | → | 10: | *10.9 | ↙ | Serie | | 98.0 | Total | | 98.0 |
| 1: | 10.5 | ↖ | | | | | | | | | | | | | | | | | | | | | | | | | | | | | | | | | | | |
| 2: | 10.2 | ↓ | | | | | | | | | | | | | | | | | | | | | | | | | | | | | | | | | | | |
| 3: | 10.4 | ↗ | | | | | | | | | | | | | | | | | | | | | | | | | | | | | | | | | | | |
| 4: | *10.6 | ↓ | | | | | | | | | | | | | | | | | | | | | | | | | | | | | | | | | | | |
| 5: | *10.9 | ↗ | | | | | | | | | | | | | | | | | | | | | | | | | | | | | | | | | | | |
| 6: | 9.9 | → | | | | | | | | | | | | | | | | | | | | | | | | | | | | | | | | | | | |
| 7: | 9.9 | ↖ | | | | | | | | | | | | | | | | | | | | | | | | | | | | | | | | | | | |
| 8: | *10.6 | ↗ | | | | | | | | | | | | | | | | | | | | | | | | | | | | | | | | | | | |
| 9: | 10.1 | → | | | | | | | | | | | | | | | | | | | | | | | | | | | | | | | | | | | |
| 10: | *10.9 | ↙ | | | | | | | | | | | | | | | | | | | | | | | | | | | | | | | | | | | |
| Serie | | 98.0 | | | | | | | | | | | | | | | | | | | | | | | | | | | | | | | | | | | |
| Total | | 98.0 | | | | | | | | | | | | | | | | | | | | | | | | | | | | | | | | | | | |

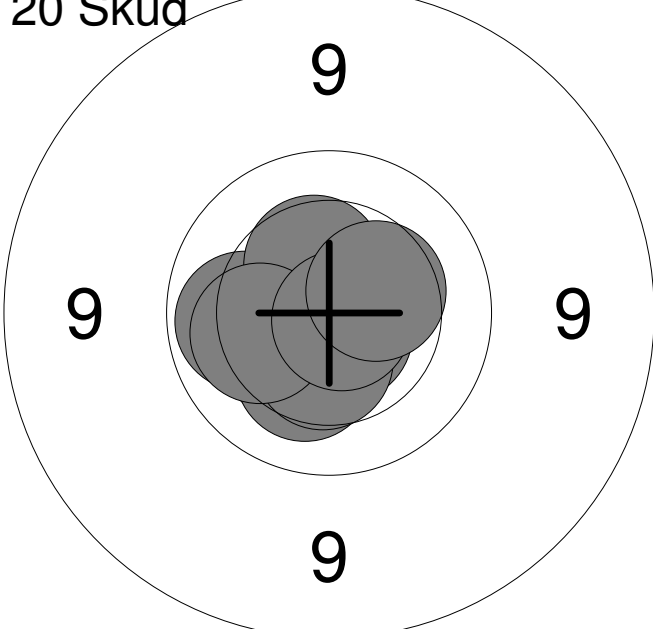
| | | | | | | | | | | | | | | | | | | | | | | | | | | | | | | | | | | | | | |
|--|--|--------------|------|---|-----|------|---|-----|-------|---|-----|------|---|-----|------|---|-----|------|---|-----|------|---|-----|------|---|-----|-------|---|-----|------|---|--------------|--|--------------|--------------|--|--------------|
| <p>20 Skud</p>  | <table style="width:100%; border-collapse: collapse;"> <tr><td style="width:10%;">11:</td><td style="width:15%;">10.4</td><td style="width:10%; text-align: right;">↙</td></tr> <tr><td>12:</td><td>10.0</td><td style="text-align: right;">←</td></tr> <tr><td>13:</td><td>*10.7</td><td style="text-align: right;">↓</td></tr> <tr><td>14:</td><td>10.5</td><td style="text-align: right;">↙</td></tr> <tr><td>15:</td><td>10.4</td><td style="text-align: right;">↗</td></tr> <tr><td>16:</td><td>10.3</td><td style="text-align: right;">↙</td></tr> <tr><td>17:</td><td>10.4</td><td style="text-align: right;">↙</td></tr> <tr><td>18:</td><td>10.2</td><td style="text-align: right;">←</td></tr> <tr><td>19:</td><td>*10.8</td><td style="text-align: right;">↘</td></tr> <tr><td>20:</td><td>10.4</td><td style="text-align: right;">↗</td></tr> <tr><td colspan="2">Serie</td><td style="text-align: right;">100.0</td></tr> <tr><td colspan="2">Total</td><td style="text-align: right;">198.0</td></tr> </table> | 11: | 10.4 | ↙ | 12: | 10.0 | ← | 13: | *10.7 | ↓ | 14: | 10.5 | ↙ | 15: | 10.4 | ↗ | 16: | 10.3 | ↙ | 17: | 10.4 | ↙ | 18: | 10.2 | ← | 19: | *10.8 | ↘ | 20: | 10.4 | ↗ | Serie | | 100.0 | Total | | 198.0 |
| 11: | 10.4 | ↙ | | | | | | | | | | | | | | | | | | | | | | | | | | | | | | | | | | | |
| 12: | 10.0 | ← | | | | | | | | | | | | | | | | | | | | | | | | | | | | | | | | | | | |
| 13: | *10.7 | ↓ | | | | | | | | | | | | | | | | | | | | | | | | | | | | | | | | | | | |
| 14: | 10.5 | ↙ | | | | | | | | | | | | | | | | | | | | | | | | | | | | | | | | | | | |
| 15: | 10.4 | ↗ | | | | | | | | | | | | | | | | | | | | | | | | | | | | | | | | | | | |
| 16: | 10.3 | ↙ | | | | | | | | | | | | | | | | | | | | | | | | | | | | | | | | | | | |
| 17: | 10.4 | ↙ | | | | | | | | | | | | | | | | | | | | | | | | | | | | | | | | | | | |
| 18: | 10.2 | ← | | | | | | | | | | | | | | | | | | | | | | | | | | | | | | | | | | | |
| 19: | *10.8 | ↘ | | | | | | | | | | | | | | | | | | | | | | | | | | | | | | | | | | | |
| 20: | 10.4 | ↗ | | | | | | | | | | | | | | | | | | | | | | | | | | | | | | | | | | | |
| Serie | | 100.0 | | | | | | | | | | | | | | | | | | | | | | | | | | | | | | | | | | | |
| Total | | 198.0 | | | | | | | | | | | | | | | | | | | | | | | | | | | | | | | | | | | |

| | | | | | | | | | | | | | | | | | | | | | | | | | |
|---------------------|---|----|-----|---|----|------|---|----|------|---|----|------|---|----|-------|---|----|------|---|----|-------|---|----|-------|---|
| <p>Prøve</p> | <table style="width:100%; border-collapse: collapse;"> <tr><td>1:</td><td>9.3</td><td>↙</td></tr> <tr><td>2:</td><td>10.3</td><td>←</td></tr> <tr><td>3:</td><td>10.4</td><td>↘</td></tr> <tr><td>4:</td><td>10.1</td><td>↗</td></tr> <tr><td>5:</td><td>*10.7</td><td>↑</td></tr> <tr><td>6:</td><td>10.0</td><td>←</td></tr> <tr><td>7:</td><td>*10.7</td><td>↙</td></tr> <tr><td>8:</td><td>*10.8</td><td>←</td></tr> </table> | 1: | 9.3 | ↙ | 2: | 10.3 | ← | 3: | 10.4 | ↘ | 4: | 10.1 | ↗ | 5: | *10.7 | ↑ | 6: | 10.0 | ← | 7: | *10.7 | ↙ | 8: | *10.8 | ← |
| 1: | 9.3 | ↙ | | | | | | | | | | | | | | | | | | | | | | | |
| 2: | 10.3 | ← | | | | | | | | | | | | | | | | | | | | | | | |
| 3: | 10.4 | ↘ | | | | | | | | | | | | | | | | | | | | | | | |
| 4: | 10.1 | ↗ | | | | | | | | | | | | | | | | | | | | | | | |
| 5: | *10.7 | ↑ | | | | | | | | | | | | | | | | | | | | | | | |
| 6: | 10.0 | ← | | | | | | | | | | | | | | | | | | | | | | | |
| 7: | *10.7 | ↙ | | | | | | | | | | | | | | | | | | | | | | | |
| 8: | *10.8 | ← | | | | | | | | | | | | | | | | | | | | | | | |
| | Serie 79.0 | | | | | | | | | | | | | | | | | | | | | | | | |
| | Total 0.0 | | | | | | | | | | | | | | | | | | | | | | | | |

| | | | | | | | | | | | | | | | | | | | | | | | | | | | | | | | |
|-----------------------|---|----|-------|---|----|------|---|----|-------|---|----|-------|---|----|-------|---|----|-------|---|----|-------|---|----|-------|---|----|-------|---|-----|-------|---|
| <p>20 Skud</p> | <table style="width:100%; border-collapse: collapse;"> <tr><td>1:</td><td>*10.6</td><td>↑</td></tr> <tr><td>2:</td><td>10.3</td><td>←</td></tr> <tr><td>3:</td><td>*10.6</td><td>↑</td></tr> <tr><td>4:</td><td>*10.5</td><td>↘</td></tr> <tr><td>5:</td><td>*10.8</td><td>↗</td></tr> <tr><td>6:</td><td>*10.5</td><td>↗</td></tr> <tr><td>7:</td><td>*10.6</td><td>↑</td></tr> <tr><td>8:</td><td>*10.7</td><td>↘</td></tr> <tr><td>9:</td><td>*10.6</td><td>↘</td></tr> <tr><td>10:</td><td>*10.7</td><td>↘</td></tr> </table> | 1: | *10.6 | ↑ | 2: | 10.3 | ← | 3: | *10.6 | ↑ | 4: | *10.5 | ↘ | 5: | *10.8 | ↗ | 6: | *10.5 | ↗ | 7: | *10.6 | ↑ | 8: | *10.7 | ↘ | 9: | *10.6 | ↘ | 10: | *10.7 | ↘ |
| 1: | *10.6 | ↑ | | | | | | | | | | | | | | | | | | | | | | | | | | | | | |
| 2: | 10.3 | ← | | | | | | | | | | | | | | | | | | | | | | | | | | | | | |
| 3: | *10.6 | ↑ | | | | | | | | | | | | | | | | | | | | | | | | | | | | | |
| 4: | *10.5 | ↘ | | | | | | | | | | | | | | | | | | | | | | | | | | | | | |
| 5: | *10.8 | ↗ | | | | | | | | | | | | | | | | | | | | | | | | | | | | | |
| 6: | *10.5 | ↗ | | | | | | | | | | | | | | | | | | | | | | | | | | | | | |
| 7: | *10.6 | ↑ | | | | | | | | | | | | | | | | | | | | | | | | | | | | | |
| 8: | *10.7 | ↘ | | | | | | | | | | | | | | | | | | | | | | | | | | | | | |
| 9: | *10.6 | ↘ | | | | | | | | | | | | | | | | | | | | | | | | | | | | | |
| 10: | *10.7 | ↘ | | | | | | | | | | | | | | | | | | | | | | | | | | | | | |
| | Serie 100.0 | | | | | | | | | | | | | | | | | | | | | | | | | | | | | | |
| | Total 100.0 | | | | | | | | | | | | | | | | | | | | | | | | | | | | | | |

| | | | | | | | | | | | | | | | | | | | | | | | | | | | | | | | |
|-----------------------|--|-----|------|---|-----|-------|---|-----|------|---|-----|-------|---|-----|-------|---|-----|-------|---|-----|-------|---|-----|------|---|-----|-------|---|-----|-------|---|
| <p>20 Skud</p> | <table style="width:100%; border-collapse: collapse;"> <tr><td>11:</td><td>10.5</td><td>↘</td></tr> <tr><td>12:</td><td>*10.7</td><td>↘</td></tr> <tr><td>13:</td><td>10.2</td><td>↗</td></tr> <tr><td>14:</td><td>*10.9</td><td>↘</td></tr> <tr><td>15:</td><td>*10.6</td><td>←</td></tr> <tr><td>16:</td><td>*10.9</td><td>↘</td></tr> <tr><td>17:</td><td>*10.8</td><td>→</td></tr> <tr><td>18:</td><td>10.1</td><td>↗</td></tr> <tr><td>19:</td><td>*10.7</td><td>→</td></tr> <tr><td>20:</td><td>*10.7</td><td>↘</td></tr> </table> | 11: | 10.5 | ↘ | 12: | *10.7 | ↘ | 13: | 10.2 | ↗ | 14: | *10.9 | ↘ | 15: | *10.6 | ← | 16: | *10.9 | ↘ | 17: | *10.8 | → | 18: | 10.1 | ↗ | 19: | *10.7 | → | 20: | *10.7 | ↘ |
| 11: | 10.5 | ↘ | | | | | | | | | | | | | | | | | | | | | | | | | | | | | |
| 12: | *10.7 | ↘ | | | | | | | | | | | | | | | | | | | | | | | | | | | | | |
| 13: | 10.2 | ↗ | | | | | | | | | | | | | | | | | | | | | | | | | | | | | |
| 14: | *10.9 | ↘ | | | | | | | | | | | | | | | | | | | | | | | | | | | | | |
| 15: | *10.6 | ← | | | | | | | | | | | | | | | | | | | | | | | | | | | | | |
| 16: | *10.9 | ↘ | | | | | | | | | | | | | | | | | | | | | | | | | | | | | |
| 17: | *10.8 | → | | | | | | | | | | | | | | | | | | | | | | | | | | | | | |
| 18: | 10.1 | ↗ | | | | | | | | | | | | | | | | | | | | | | | | | | | | | |
| 19: | *10.7 | → | | | | | | | | | | | | | | | | | | | | | | | | | | | | | |
| 20: | *10.7 | ↘ | | | | | | | | | | | | | | | | | | | | | | | | | | | | | |
| | Serie 100.0 | | | | | | | | | | | | | | | | | | | | | | | | | | | | | | |
| | Total 200.0 | | | | | | | | | | | | | | | | | | | | | | | | | | | | | | |

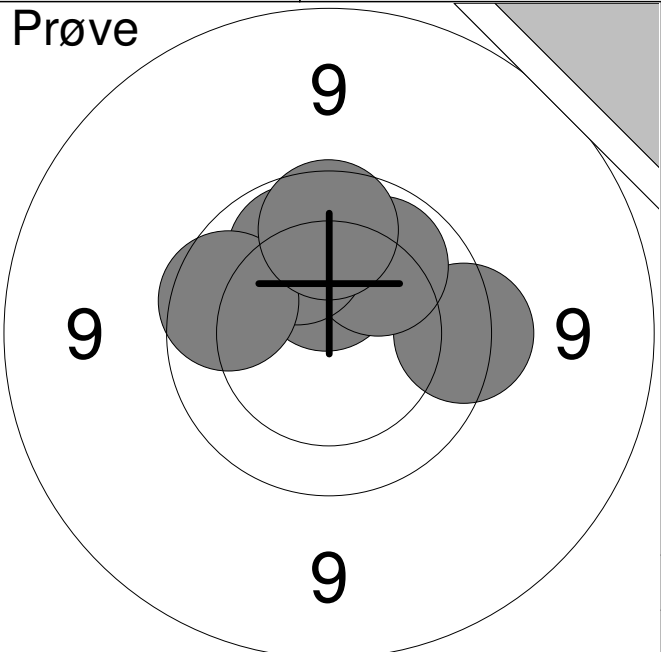
| | | | | | | | | | | | | | | | | | | | |
|--|---|-------|------|-------|-----|------|---|----|------|---|----|------|---|----|-----|---|----|-----|---|
| <p>Prøve</p>  | <table style="width:100%;"> <tr><td>1:</td><td>9.7</td><td>→</td></tr> <tr><td>2:</td><td>10.4</td><td>↑</td></tr> <tr><td>3:</td><td>10.1</td><td>↗</td></tr> <tr><td>4:</td><td>10.0</td><td>↖</td></tr> <tr><td>5:</td><td>9.9</td><td>←</td></tr> <tr><td>6:</td><td>9.9</td><td>↑</td></tr> </table> | 1: | 9.7 | → | 2: | 10.4 | ↑ | 3: | 10.1 | ↗ | 4: | 10.0 | ↖ | 5: | 9.9 | ← | 6: | 9.9 | ↑ |
| 1: | 9.7 | → | | | | | | | | | | | | | | | | | |
| 2: | 10.4 | ↑ | | | | | | | | | | | | | | | | | |
| 3: | 10.1 | ↗ | | | | | | | | | | | | | | | | | |
| 4: | 10.0 | ↖ | | | | | | | | | | | | | | | | | |
| 5: | 9.9 | ← | | | | | | | | | | | | | | | | | |
| 6: | 9.9 | ↑ | | | | | | | | | | | | | | | | | |
| | <table border="1" style="width:100%; border-collapse: collapse;"> <tr> <td style="width:80%;">Serie</td> <td style="text-align: right;">57.0</td> </tr> <tr> <td>Total</td> <td style="text-align: right;">0.0</td> </tr> </table> | Serie | 57.0 | Total | 0.0 | | | | | | | | | | | | | | |
| Serie | 57.0 | | | | | | | | | | | | | | | | | | |
| Total | 0.0 | | | | | | | | | | | | | | | | | | |

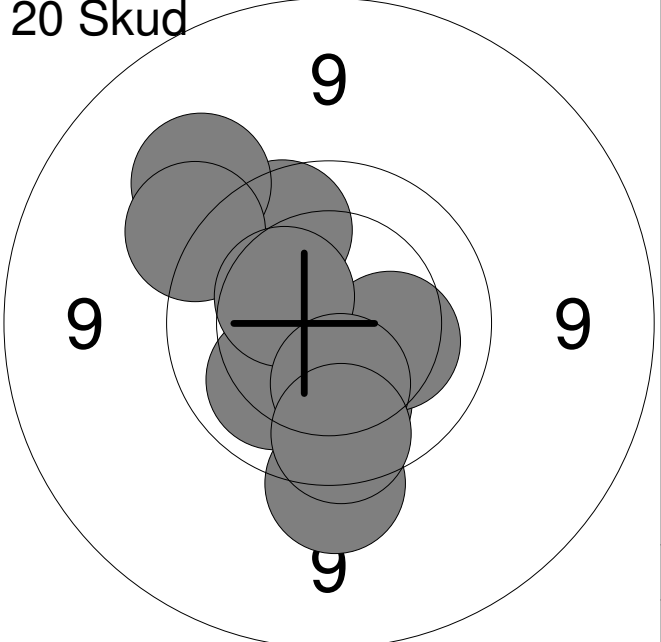
| | | | | | | | | | | | | | | | | | | | | | | | | | | | | | | | |
|---|--|-------|------|-------|------|------|---|----|------|---|----|-----|---|----|------|---|----|-----|---|----|------|---|----|-----|---|----|------|---|-----|-----|---|
| <p>20 Skud</p>  | <table style="width:100%;"> <tr><td>1:</td><td>9.9</td><td>↗</td></tr> <tr><td>2:</td><td>10.1</td><td>↓</td></tr> <tr><td>3:</td><td>10.1</td><td>↖</td></tr> <tr><td>4:</td><td>9.4</td><td>↗</td></tr> <tr><td>5:</td><td>10.3</td><td>→</td></tr> <tr><td>6:</td><td>9.5</td><td>↗</td></tr> <tr><td>7:</td><td>10.4</td><td>↗</td></tr> <tr><td>8:</td><td>9.5</td><td>↓</td></tr> <tr><td>9:</td><td>10.3</td><td>↓</td></tr> <tr><td>10:</td><td>9.8</td><td>↓</td></tr> </table> | 1: | 9.9 | ↗ | 2: | 10.1 | ↓ | 3: | 10.1 | ↖ | 4: | 9.4 | ↗ | 5: | 10.3 | → | 6: | 9.5 | ↗ | 7: | 10.4 | ↗ | 8: | 9.5 | ↓ | 9: | 10.3 | ↓ | 10: | 9.8 | ↓ |
| 1: | 9.9 | ↗ | | | | | | | | | | | | | | | | | | | | | | | | | | | | | |
| 2: | 10.1 | ↓ | | | | | | | | | | | | | | | | | | | | | | | | | | | | | |
| 3: | 10.1 | ↖ | | | | | | | | | | | | | | | | | | | | | | | | | | | | | |
| 4: | 9.4 | ↗ | | | | | | | | | | | | | | | | | | | | | | | | | | | | | |
| 5: | 10.3 | → | | | | | | | | | | | | | | | | | | | | | | | | | | | | | |
| 6: | 9.5 | ↗ | | | | | | | | | | | | | | | | | | | | | | | | | | | | | |
| 7: | 10.4 | ↗ | | | | | | | | | | | | | | | | | | | | | | | | | | | | | |
| 8: | 9.5 | ↓ | | | | | | | | | | | | | | | | | | | | | | | | | | | | | |
| 9: | 10.3 | ↓ | | | | | | | | | | | | | | | | | | | | | | | | | | | | | |
| 10: | 9.8 | ↓ | | | | | | | | | | | | | | | | | | | | | | | | | | | | | |
| | <table border="1" style="width:100%; border-collapse: collapse;"> <tr> <td style="width:80%;">Serie</td> <td style="text-align: right;">95.0</td> </tr> <tr> <td>Total</td> <td style="text-align: right;">95.0</td> </tr> </table> | Serie | 95.0 | Total | 95.0 | | | | | | | | | | | | | | | | | | | | | | | | | | |
| Serie | 95.0 | | | | | | | | | | | | | | | | | | | | | | | | | | | | | | |
| Total | 95.0 | | | | | | | | | | | | | | | | | | | | | | | | | | | | | | |

| | | | | | | | | | | | | | | | | | | | | | | | | | | | | | | | |
|--|--|-------|------|-------|-------|------|---|-----|------|---|-----|-----|---|-----|------|---|-----|-----|---|-----|------|---|-----|------|---|-----|-------|---|-----|-----|---|
| <p>20 Skud</p>  | <table style="width:100%;"> <tr><td>11:</td><td>10.0</td><td>↗</td></tr> <tr><td>12:</td><td>10.5</td><td>↖</td></tr> <tr><td>13:</td><td>10.1</td><td>↗</td></tr> <tr><td>14:</td><td>9.6</td><td>→</td></tr> <tr><td>15:</td><td>10.0</td><td>→</td></tr> <tr><td>16:</td><td>9.5</td><td>↗</td></tr> <tr><td>17:</td><td>10.3</td><td>↗</td></tr> <tr><td>18:</td><td>10.0</td><td>↗</td></tr> <tr><td>19:</td><td>*10.5</td><td>↖</td></tr> <tr><td>20:</td><td>9.8</td><td>←</td></tr> </table> | 11: | 10.0 | ↗ | 12: | 10.5 | ↖ | 13: | 10.1 | ↗ | 14: | 9.6 | → | 15: | 10.0 | → | 16: | 9.5 | ↗ | 17: | 10.3 | ↗ | 18: | 10.0 | ↗ | 19: | *10.5 | ↖ | 20: | 9.8 | ← |
| 11: | 10.0 | ↗ | | | | | | | | | | | | | | | | | | | | | | | | | | | | | |
| 12: | 10.5 | ↖ | | | | | | | | | | | | | | | | | | | | | | | | | | | | | |
| 13: | 10.1 | ↗ | | | | | | | | | | | | | | | | | | | | | | | | | | | | | |
| 14: | 9.6 | → | | | | | | | | | | | | | | | | | | | | | | | | | | | | | |
| 15: | 10.0 | → | | | | | | | | | | | | | | | | | | | | | | | | | | | | | |
| 16: | 9.5 | ↗ | | | | | | | | | | | | | | | | | | | | | | | | | | | | | |
| 17: | 10.3 | ↗ | | | | | | | | | | | | | | | | | | | | | | | | | | | | | |
| 18: | 10.0 | ↗ | | | | | | | | | | | | | | | | | | | | | | | | | | | | | |
| 19: | *10.5 | ↖ | | | | | | | | | | | | | | | | | | | | | | | | | | | | | |
| 20: | 9.8 | ← | | | | | | | | | | | | | | | | | | | | | | | | | | | | | |
| | <table border="1" style="width:100%; border-collapse: collapse;"> <tr> <td style="width:80%;">Serie</td> <td style="text-align: right;">97.0</td> </tr> <tr> <td>Total</td> <td style="text-align: right;">192.0</td> </tr> </table> | Serie | 97.0 | Total | 192.0 | | | | | | | | | | | | | | | | | | | | | | | | | | |
| Serie | 97.0 | | | | | | | | | | | | | | | | | | | | | | | | | | | | | | |
| Total | 192.0 | | | | | | | | | | | | | | | | | | | | | | | | | | | | | | |

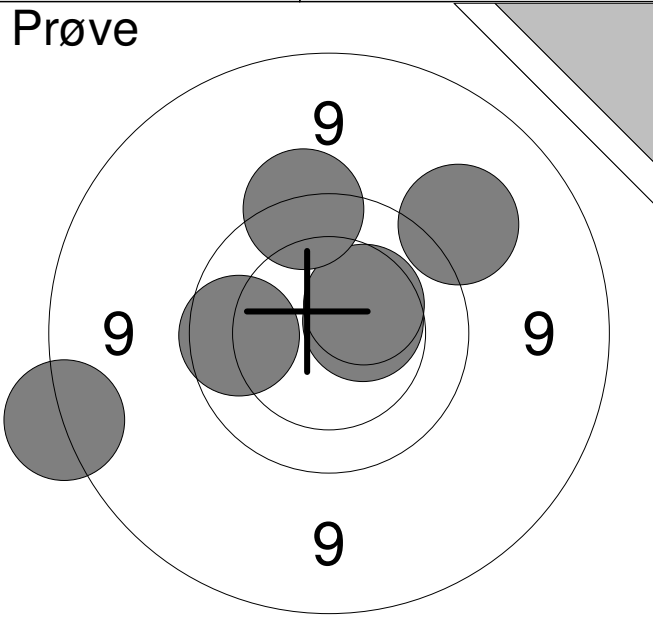
| | | | | | | | | | | | | | | | | | | | |
|--|--|-------|------|-------|-----|-------|---|----|------|---|----|-----|---|----|-----|---|----|-----|---|
| <p>Prøve</p>  | <table style="width:100%; border-collapse: collapse;"> <tr><td>1:</td><td>9.3</td><td>↗</td></tr> <tr><td>2:</td><td>*10.5</td><td>→</td></tr> <tr><td>3:</td><td>10.4</td><td>↗</td></tr> <tr><td>4:</td><td>9.9</td><td>←</td></tr> <tr><td>5:</td><td>8.7</td><td>←</td></tr> <tr><td>6:</td><td>9.6</td><td>↑</td></tr> </table> | 1: | 9.3 | ↗ | 2: | *10.5 | → | 3: | 10.4 | ↗ | 4: | 9.9 | ← | 5: | 8.7 | ← | 6: | 9.6 | ↑ |
| 1: | 9.3 | ↗ | | | | | | | | | | | | | | | | | |
| 2: | *10.5 | → | | | | | | | | | | | | | | | | | |
| 3: | 10.4 | ↗ | | | | | | | | | | | | | | | | | |
| 4: | 9.9 | ← | | | | | | | | | | | | | | | | | |
| 5: | 8.7 | ← | | | | | | | | | | | | | | | | | |
| 6: | 9.6 | ↑ | | | | | | | | | | | | | | | | | |
| <table style="width:100%; border-collapse: collapse;"> <tr> <td style="width:45%;">Serie</td> <td style="width:55%; text-align: right;">55.0</td> </tr> <tr> <td>Total</td> <td style="text-align: right;">0.0</td> </tr> </table> | | Serie | 55.0 | Total | 0.0 | | | | | | | | | | | | | | |
| Serie | 55.0 | | | | | | | | | | | | | | | | | | |
| Total | 0.0 | | | | | | | | | | | | | | | | | | |

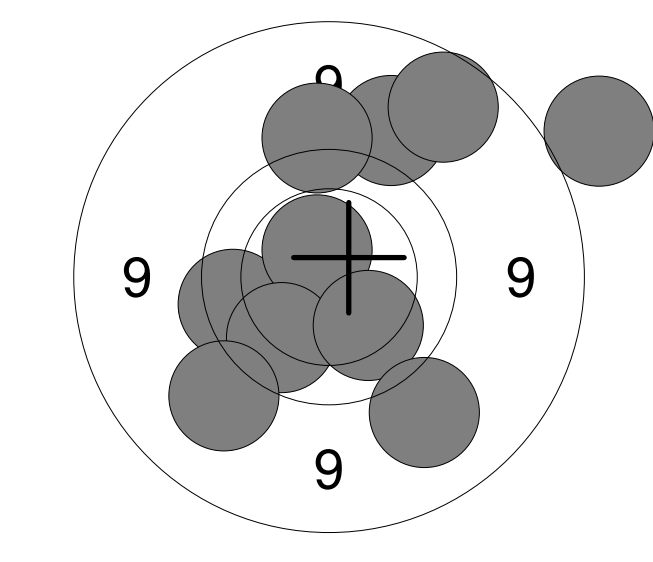
| | | | | | | | | | | | | | | | | | | | | | | | | | | | | | | | |
|---|---|-------|------|-------|------|-----|---|----|-------|---|----|-----|---|----|-----|---|----|-----|---|----|------|---|----|-----|---|----|-----|---|-----|-----|---|
| <p>20 Skud</p>  | <table style="width:100%; border-collapse: collapse;"> <tr><td>1:</td><td>8.4</td><td>↗</td></tr> <tr><td>2:</td><td>9.7</td><td>←</td></tr> <tr><td>3:</td><td>*10.5</td><td>↗</td></tr> <tr><td>4:</td><td>9.3</td><td>↗</td></tr> <tr><td>5:</td><td>8.9</td><td>↗</td></tr> <tr><td>6:</td><td>9.9</td><td>↘</td></tr> <tr><td>7:</td><td>10.1</td><td>↘</td></tr> <tr><td>8:</td><td>9.3</td><td>↘</td></tr> <tr><td>9:</td><td>9.2</td><td>↘</td></tr> <tr><td>10:</td><td>9.4</td><td>↑</td></tr> </table> | 1: | 8.4 | ↗ | 2: | 9.7 | ← | 3: | *10.5 | ↗ | 4: | 9.3 | ↗ | 5: | 8.9 | ↗ | 6: | 9.9 | ↘ | 7: | 10.1 | ↘ | 8: | 9.3 | ↘ | 9: | 9.2 | ↘ | 10: | 9.4 | ↑ |
| 1: | 8.4 | ↗ | | | | | | | | | | | | | | | | | | | | | | | | | | | | | |
| 2: | 9.7 | ← | | | | | | | | | | | | | | | | | | | | | | | | | | | | | |
| 3: | *10.5 | ↗ | | | | | | | | | | | | | | | | | | | | | | | | | | | | | |
| 4: | 9.3 | ↗ | | | | | | | | | | | | | | | | | | | | | | | | | | | | | |
| 5: | 8.9 | ↗ | | | | | | | | | | | | | | | | | | | | | | | | | | | | | |
| 6: | 9.9 | ↘ | | | | | | | | | | | | | | | | | | | | | | | | | | | | | |
| 7: | 10.1 | ↘ | | | | | | | | | | | | | | | | | | | | | | | | | | | | | |
| 8: | 9.3 | ↘ | | | | | | | | | | | | | | | | | | | | | | | | | | | | | |
| 9: | 9.2 | ↘ | | | | | | | | | | | | | | | | | | | | | | | | | | | | | |
| 10: | 9.4 | ↑ | | | | | | | | | | | | | | | | | | | | | | | | | | | | | |
| <table style="width:100%; border-collapse: collapse;"> <tr> <td style="width:45%;">Serie</td> <td style="width:55%; text-align: right;">90.0</td> </tr> <tr> <td>Total</td> <td style="text-align: right;">90.0</td> </tr> </table> | | Serie | 90.0 | Total | 90.0 | | | | | | | | | | | | | | | | | | | | | | | | | | |
| Serie | 90.0 | | | | | | | | | | | | | | | | | | | | | | | | | | | | | | |
| Total | 90.0 | | | | | | | | | | | | | | | | | | | | | | | | | | | | | | |

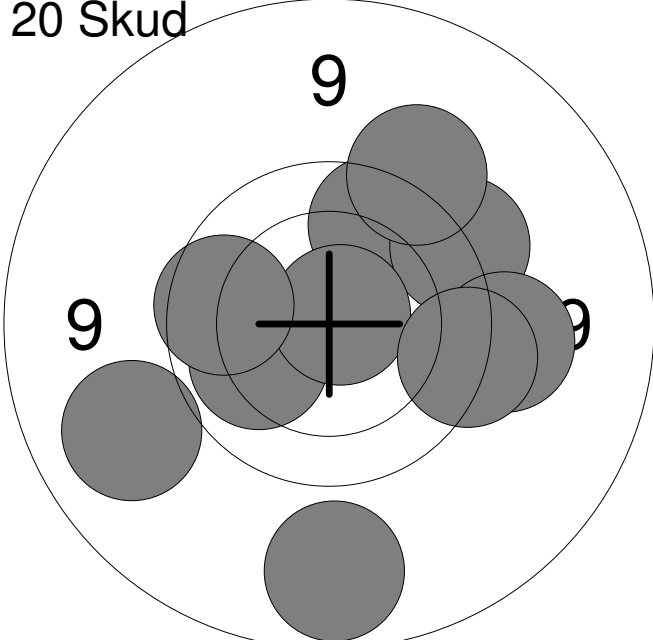
| | | | | | | | | | | | | | | | | | | | | | | | | | | | | | | | |
|--|--|-------|------|-------|-------|-----|---|-----|-----|---|-----|------|---|-----|-----|---|-----|-------|---|-----|-----|---|-----|-----|---|-----|-----|---|-----|-----|---|
| <p>20 Skud</p>  | <table style="width:100%; border-collapse: collapse;"> <tr><td>11:</td><td>9.0</td><td>↓</td></tr> <tr><td>12:</td><td>9.1</td><td>←</td></tr> <tr><td>13:</td><td>9.8</td><td>↗</td></tr> <tr><td>14:</td><td>10.1</td><td>←</td></tr> <tr><td>15:</td><td>9.6</td><td>↗</td></tr> <tr><td>16:</td><td>*10.8</td><td>↗</td></tr> <tr><td>17:</td><td>9.5</td><td>↗</td></tr> <tr><td>18:</td><td>9.4</td><td>→</td></tr> <tr><td>19:</td><td>9.6</td><td>→</td></tr> <tr><td>20:</td><td>9.9</td><td>←</td></tr> </table> | 11: | 9.0 | ↓ | 12: | 9.1 | ← | 13: | 9.8 | ↗ | 14: | 10.1 | ← | 15: | 9.6 | ↗ | 16: | *10.8 | ↗ | 17: | 9.5 | ↗ | 18: | 9.4 | → | 19: | 9.6 | → | 20: | 9.9 | ← |
| 11: | 9.0 | ↓ | | | | | | | | | | | | | | | | | | | | | | | | | | | | | |
| 12: | 9.1 | ← | | | | | | | | | | | | | | | | | | | | | | | | | | | | | |
| 13: | 9.8 | ↗ | | | | | | | | | | | | | | | | | | | | | | | | | | | | | |
| 14: | 10.1 | ← | | | | | | | | | | | | | | | | | | | | | | | | | | | | | |
| 15: | 9.6 | ↗ | | | | | | | | | | | | | | | | | | | | | | | | | | | | | |
| 16: | *10.8 | ↗ | | | | | | | | | | | | | | | | | | | | | | | | | | | | | |
| 17: | 9.5 | ↗ | | | | | | | | | | | | | | | | | | | | | | | | | | | | | |
| 18: | 9.4 | → | | | | | | | | | | | | | | | | | | | | | | | | | | | | | |
| 19: | 9.6 | → | | | | | | | | | | | | | | | | | | | | | | | | | | | | | |
| 20: | 9.9 | ← | | | | | | | | | | | | | | | | | | | | | | | | | | | | | |
| <table style="width:100%; border-collapse: collapse;"> <tr> <td style="width:45%;">Serie</td> <td style="width:55%; text-align: right;">92.0</td> </tr> <tr> <td>Total</td> <td style="text-align: right;">182.0</td> </tr> </table> | | Serie | 92.0 | Total | 182.0 | | | | | | | | | | | | | | | | | | | | | | | | | | |
| Serie | 92.0 | | | | | | | | | | | | | | | | | | | | | | | | | | | | | | |
| Total | 182.0 | | | | | | | | | | | | | | | | | | | | | | | | | | | | | | |

Hold
22Skive
12**Mathias Stevn**

Hjørring Skytteforening

J2

Prøve

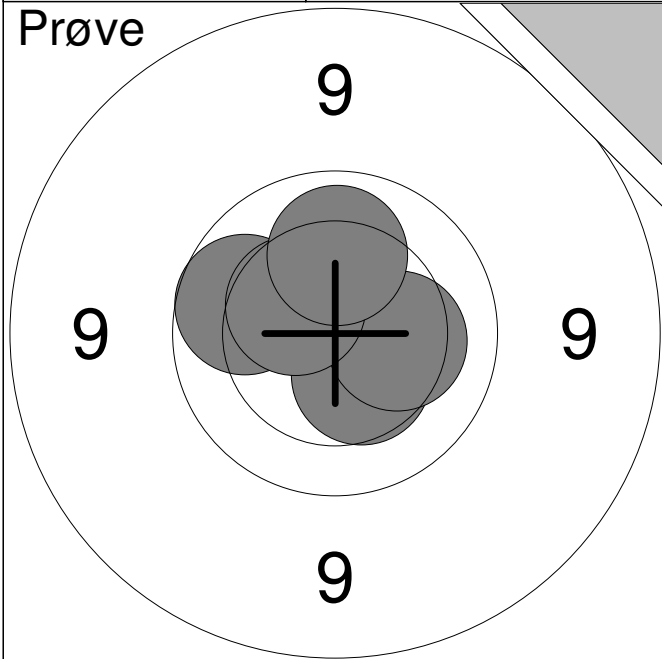

1: 10.4



2: 10.3



3: 9.9



4: 10.4



5: 10.1



Serie

49.0

Total

0.0

20 Skud

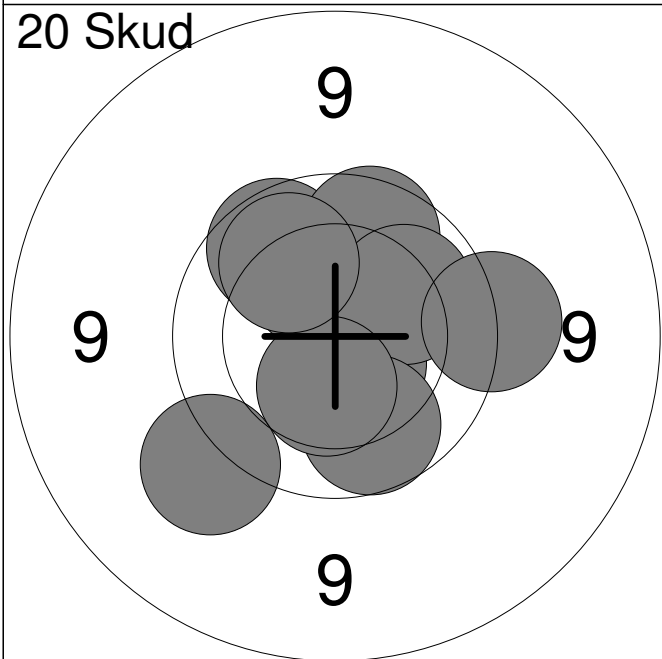

1: 9.9



2: 10.3



3: 9.9



4: *10.6



5: 9.4



6: 10.1



7: 9.6



8: 9.9



9: 10.4



10: 10.0



Serie

95.0

Total

95.0

20 Skud

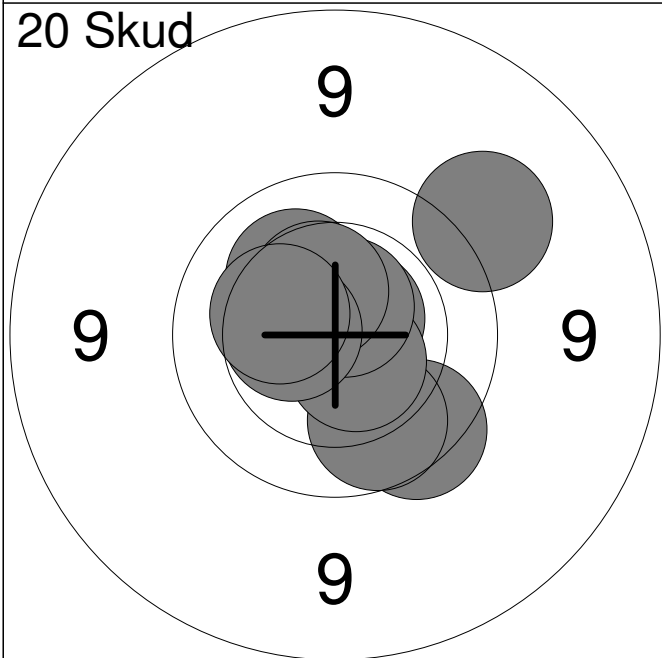

11: 9.7



12: 9.9



13: 10.2



14: *10.7



15: *10.6



16: *10.6



17: 10.4



18: 9.4



19: 10.5



20: 10.3



Serie

97.0

Total

192.0

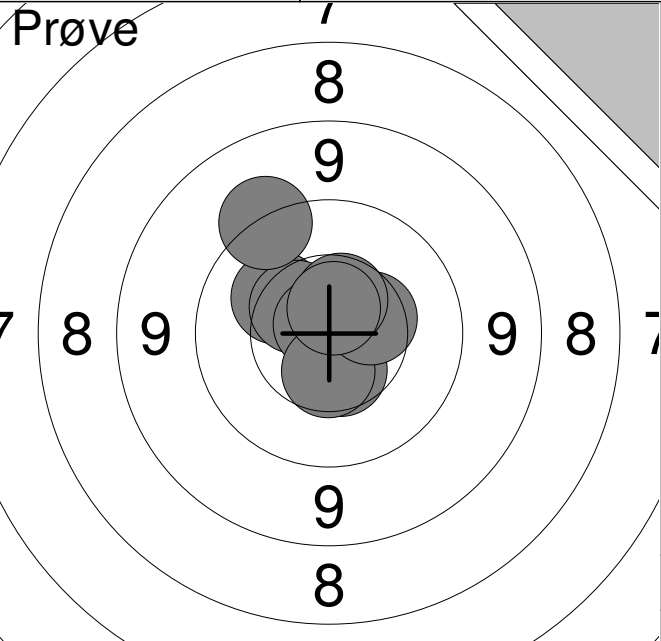
| | | | | | | | | | | | | | | | | | | | | | | | | | | | | | | | |
|--|---|-------|------|------|-------|------|-----|----|-----|---|----|-------|---|----|-------|---|----|------|---|----|------|---|----|------|---|----|------|---|-----|-------|---|
| Prøve  | <table style="width:100%; border-collapse: collapse;"> <tr><td style="width:10%;">1:</td><td style="width:80%;">10.2</td><td style="width:10%; text-align: right;">↗</td></tr> <tr><td>2:</td><td>10.5</td><td style="text-align: right;">↗</td></tr> <tr><td>3:</td><td>9.4</td><td style="text-align: right;">↗</td></tr> <tr><td>4:</td><td>*10.8</td><td style="text-align: right;">↗</td></tr> <tr><td>5:</td><td>*10.7</td><td style="text-align: right;">↗</td></tr> <tr><td>6:</td><td>10.5</td><td style="text-align: right;">↘</td></tr> <tr><td>7:</td><td>10.5</td><td style="text-align: right;">↘</td></tr> <tr><td>8:</td><td>10.4</td><td style="text-align: right;">→</td></tr> <tr><td>9:</td><td>10.5</td><td style="text-align: right;">↗</td></tr> <tr><td>10:</td><td>*10.7</td><td style="text-align: right;">↗</td></tr> </table> | 1: | 10.2 | ↗ | 2: | 10.5 | ↗ | 3: | 9.4 | ↗ | 4: | *10.8 | ↗ | 5: | *10.7 | ↗ | 6: | 10.5 | ↘ | 7: | 10.5 | ↘ | 8: | 10.4 | → | 9: | 10.5 | ↗ | 10: | *10.7 | ↗ |
| 1: | 10.2 | ↗ | | | | | | | | | | | | | | | | | | | | | | | | | | | | | |
| 2: | 10.5 | ↗ | | | | | | | | | | | | | | | | | | | | | | | | | | | | | |
| 3: | 9.4 | ↗ | | | | | | | | | | | | | | | | | | | | | | | | | | | | | |
| 4: | *10.8 | ↗ | | | | | | | | | | | | | | | | | | | | | | | | | | | | | |
| 5: | *10.7 | ↗ | | | | | | | | | | | | | | | | | | | | | | | | | | | | | |
| 6: | 10.5 | ↘ | | | | | | | | | | | | | | | | | | | | | | | | | | | | | |
| 7: | 10.5 | ↘ | | | | | | | | | | | | | | | | | | | | | | | | | | | | | |
| 8: | 10.4 | → | | | | | | | | | | | | | | | | | | | | | | | | | | | | | |
| 9: | 10.5 | ↗ | | | | | | | | | | | | | | | | | | | | | | | | | | | | | |
| 10: | *10.7 | ↗ | | | | | | | | | | | | | | | | | | | | | | | | | | | | | |
| | <table style="width:100%; border-collapse: collapse;"> <tr> <td style="width:10%;">Serie</td> <td style="width:80%;"></td> <td style="width:10%; text-align: right;">99.0</td> </tr> <tr> <td>Total</td> <td></td> <td style="text-align: right;">0.0</td> </tr> </table> | Serie | | 99.0 | Total | | 0.0 | | | | | | | | | | | | | | | | | | | | | | | | |
| Serie | | 99.0 | | | | | | | | | | | | | | | | | | | | | | | | | | | | | |
| Total | | 0.0 | | | | | | | | | | | | | | | | | | | | | | | | | | | | | |

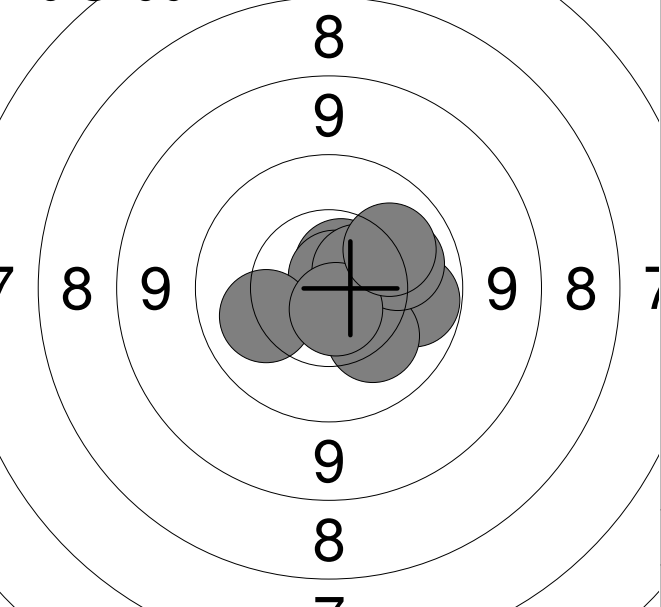
| | | | | | | | | | | | | | | | | | | | | | | | | | | | | | | | |
|---|---|-------|-------|-------|-------|-------|-------|----|-------|---|----|------|---|----|------|---|----|------|---|----|------|---|----|------|---|----|-------|---|-----|------|---|
| 20 Skud  | <table style="width:100%; border-collapse: collapse;"> <tr><td style="width:10%;">1:</td><td style="width:80%;">*10.7</td><td style="width:10%; text-align: right;">↗</td></tr> <tr><td>2:</td><td>*10.8</td><td style="text-align: right;">→</td></tr> <tr><td>3:</td><td>*10.8</td><td style="text-align: right;">↗</td></tr> <tr><td>4:</td><td>10.2</td><td style="text-align: right;">↖</td></tr> <tr><td>5:</td><td>10.0</td><td style="text-align: right;">→</td></tr> <tr><td>6:</td><td>10.6</td><td style="text-align: right;">↗</td></tr> <tr><td>7:</td><td>10.2</td><td style="text-align: right;">↘</td></tr> <tr><td>8:</td><td>10.1</td><td style="text-align: right;">→</td></tr> <tr><td>9:</td><td>*10.7</td><td style="text-align: right;">↘</td></tr> <tr><td>10:</td><td>10.1</td><td style="text-align: right;">↗</td></tr> </table> | 1: | *10.7 | ↗ | 2: | *10.8 | → | 3: | *10.8 | ↗ | 4: | 10.2 | ↖ | 5: | 10.0 | → | 6: | 10.6 | ↗ | 7: | 10.2 | ↘ | 8: | 10.1 | → | 9: | *10.7 | ↘ | 10: | 10.1 | ↗ |
| 1: | *10.7 | ↗ | | | | | | | | | | | | | | | | | | | | | | | | | | | | | |
| 2: | *10.8 | → | | | | | | | | | | | | | | | | | | | | | | | | | | | | | |
| 3: | *10.8 | ↗ | | | | | | | | | | | | | | | | | | | | | | | | | | | | | |
| 4: | 10.2 | ↖ | | | | | | | | | | | | | | | | | | | | | | | | | | | | | |
| 5: | 10.0 | → | | | | | | | | | | | | | | | | | | | | | | | | | | | | | |
| 6: | 10.6 | ↗ | | | | | | | | | | | | | | | | | | | | | | | | | | | | | |
| 7: | 10.2 | ↘ | | | | | | | | | | | | | | | | | | | | | | | | | | | | | |
| 8: | 10.1 | → | | | | | | | | | | | | | | | | | | | | | | | | | | | | | |
| 9: | *10.7 | ↘ | | | | | | | | | | | | | | | | | | | | | | | | | | | | | |
| 10: | 10.1 | ↗ | | | | | | | | | | | | | | | | | | | | | | | | | | | | | |
| | <table style="width:100%; border-collapse: collapse;"> <tr> <td style="width:10%;">Serie</td> <td style="width:80%;"></td> <td style="width:10%; text-align: right;">100.0</td> </tr> <tr> <td>Total</td> <td></td> <td style="text-align: right;">100.0</td> </tr> </table> | Serie | | 100.0 | Total | | 100.0 | | | | | | | | | | | | | | | | | | | | | | | | |
| Serie | | 100.0 | | | | | | | | | | | | | | | | | | | | | | | | | | | | | |
| Total | | 100.0 | | | | | | | | | | | | | | | | | | | | | | | | | | | | | |

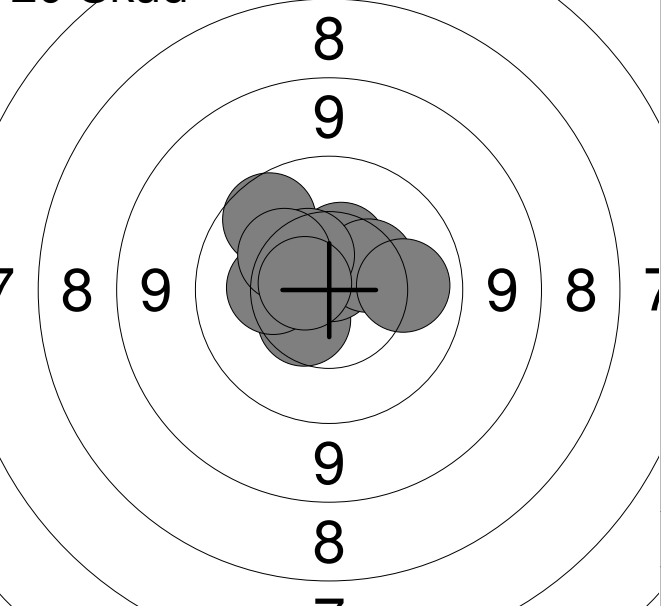
| | | | | | | | | | | | | | | | | | | | | | | | | | | | | | | | |
|--|---|-------|------|------|-------|-------|-------|-----|------|---|-----|------|---|-----|------|---|-----|------|---|-----|-----|---|-----|------|---|-----|------|---|-----|-------|---|
| 20 Skud  | <table style="width:100%; border-collapse: collapse;"> <tr><td style="width:10%;">11:</td><td style="width:80%;">10.5</td><td style="width:10%; text-align: right;">↖</td></tr> <tr><td>12:</td><td>*10.8</td><td style="text-align: right;">↗</td></tr> <tr><td>13:</td><td>10.5</td><td style="text-align: right;">↗</td></tr> <tr><td>14:</td><td>10.4</td><td style="text-align: right;">↗</td></tr> <tr><td>15:</td><td>10.3</td><td style="text-align: right;">↖</td></tr> <tr><td>16:</td><td>10.1</td><td style="text-align: right;">→</td></tr> <tr><td>17:</td><td>9.9</td><td style="text-align: right;">↗</td></tr> <tr><td>18:</td><td>10.5</td><td style="text-align: right;">↗</td></tr> <tr><td>19:</td><td>10.3</td><td style="text-align: right;">↗</td></tr> <tr><td>20:</td><td>*10.7</td><td style="text-align: right;">↖</td></tr> </table> | 11: | 10.5 | ↖ | 12: | *10.8 | ↗ | 13: | 10.5 | ↗ | 14: | 10.4 | ↗ | 15: | 10.3 | ↖ | 16: | 10.1 | → | 17: | 9.9 | ↗ | 18: | 10.5 | ↗ | 19: | 10.3 | ↗ | 20: | *10.7 | ↖ |
| 11: | 10.5 | ↖ | | | | | | | | | | | | | | | | | | | | | | | | | | | | | |
| 12: | *10.8 | ↗ | | | | | | | | | | | | | | | | | | | | | | | | | | | | | |
| 13: | 10.5 | ↗ | | | | | | | | | | | | | | | | | | | | | | | | | | | | | |
| 14: | 10.4 | ↗ | | | | | | | | | | | | | | | | | | | | | | | | | | | | | |
| 15: | 10.3 | ↖ | | | | | | | | | | | | | | | | | | | | | | | | | | | | | |
| 16: | 10.1 | → | | | | | | | | | | | | | | | | | | | | | | | | | | | | | |
| 17: | 9.9 | ↗ | | | | | | | | | | | | | | | | | | | | | | | | | | | | | |
| 18: | 10.5 | ↗ | | | | | | | | | | | | | | | | | | | | | | | | | | | | | |
| 19: | 10.3 | ↗ | | | | | | | | | | | | | | | | | | | | | | | | | | | | | |
| 20: | *10.7 | ↖ | | | | | | | | | | | | | | | | | | | | | | | | | | | | | |
| | <table style="width:100%; border-collapse: collapse;"> <tr> <td style="width:10%;">Serie</td> <td style="width:80%;"></td> <td style="width:10%; text-align: right;">99.0</td> </tr> <tr> <td>Total</td> <td></td> <td style="text-align: right;">199.0</td> </tr> </table> | Serie | | 99.0 | Total | | 199.0 | | | | | | | | | | | | | | | | | | | | | | | | |
| Serie | | 99.0 | | | | | | | | | | | | | | | | | | | | | | | | | | | | | |
| Total | | 199.0 | | | | | | | | | | | | | | | | | | | | | | | | | | | | | |

Hold
23

Skive
2

Sebastian Andersen

Løgstør Skyttelaug

MJ2

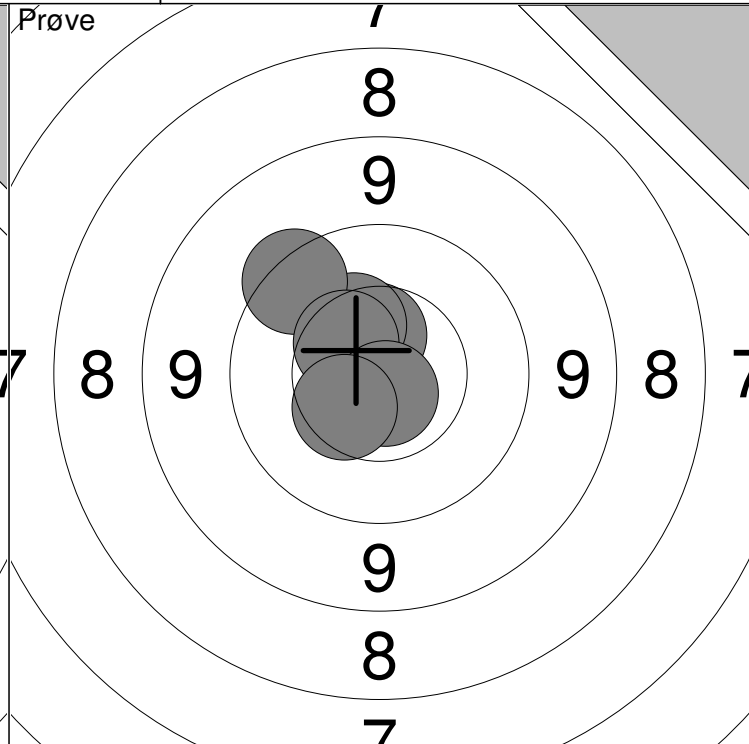
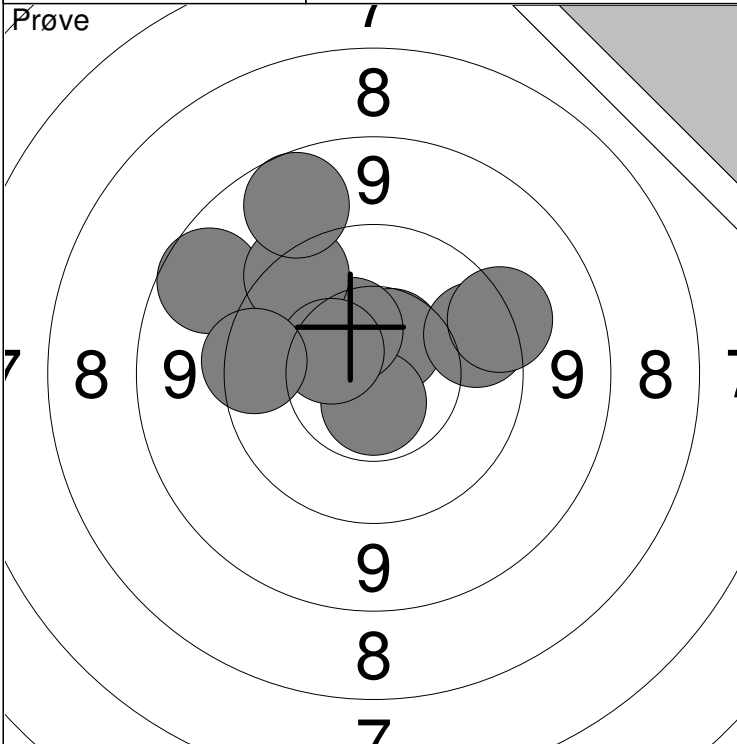

| | |
|------------|-----------|
| 1: 10.6 ↗ | 6: 8.9 ↗ |
| 2: 9.8 → | 7: 9.6 ↗ |
| 3: 9.5 → | 8: 8.9 ↗ |
| 4: *10.7 ↓ | 9: 10.5 ↗ |
| 5: 10.4 ↗ | 10: 9.7 ← |

| | |
|-------|------|
| Serie | 92.0 |
| Total | 0.0 |

| | |
|-------------|------------|
| 11: 10.5 ↗ | 16: 10.4 ↙ |
| 12: 10.4 ↗ | |
| 13: 9.6 ↗ | |
| 14: 10.5 ↗ | |
| 15: *10.7 ↓ | |

| | |
|-------|------|
| Serie | 59.0 |
| Total | 0.0 |

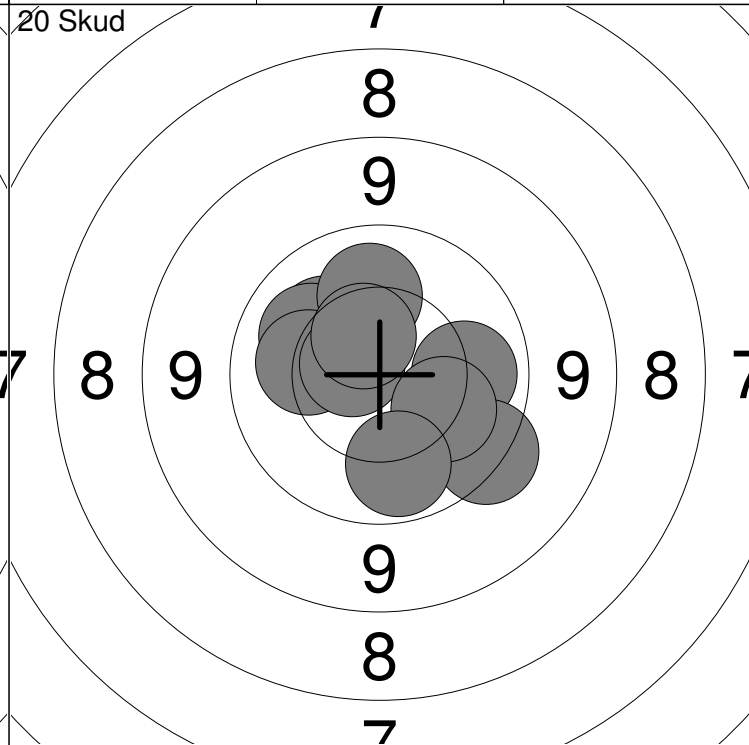
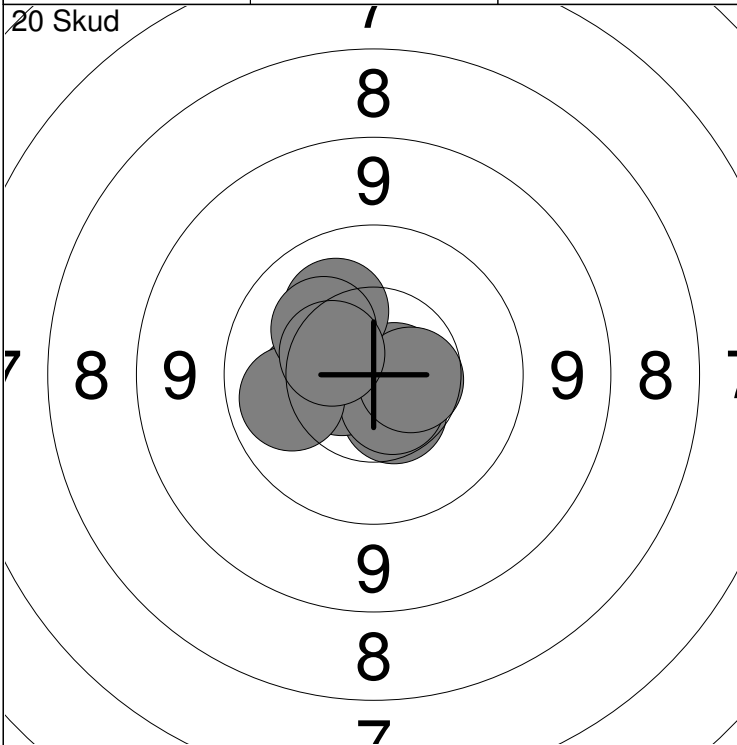

| | |
|------------|------------|
| 1: *10.7 → | 6: 10.6 → |
| 2: 10.5 ↓ | 7: 10.1 ← |
| 3: 10.3 ← | 8: 10.2 ↗ |
| 4: *10.6 ← | 9: 10.3 ↗ |
| 5: *10.6 ↓ | 10: 10.5 ↗ |

| | |
|-------|-------|
| Serie | 100.0 |
| Total | 100.0 |

| | |
|------------|-------------|
| 11: 10.2 ↗ | 16: *10.7 ↙ |
| 12: 10.1 ↗ | 17: 9.6 ↓ |
| 13: 10.2 ← | 18: 10.2 ↓ |
| 14: 10.1 → | 19: 10.0 ↓ |
| 15: 10.1 ↗ | 20: 10.5 ↗ |

| | |
|-------|-------|
| Serie | 99.0 |
| Total | 199.0 |

Hold
23

Skive
3

Magnus Anderson

Vilsted Skf.

BK2

Prøve

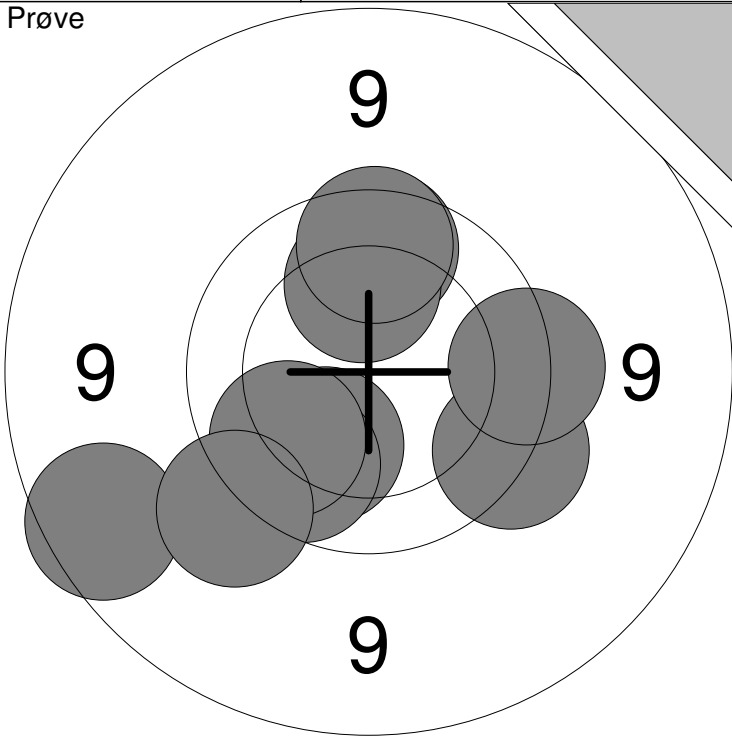

Prøve

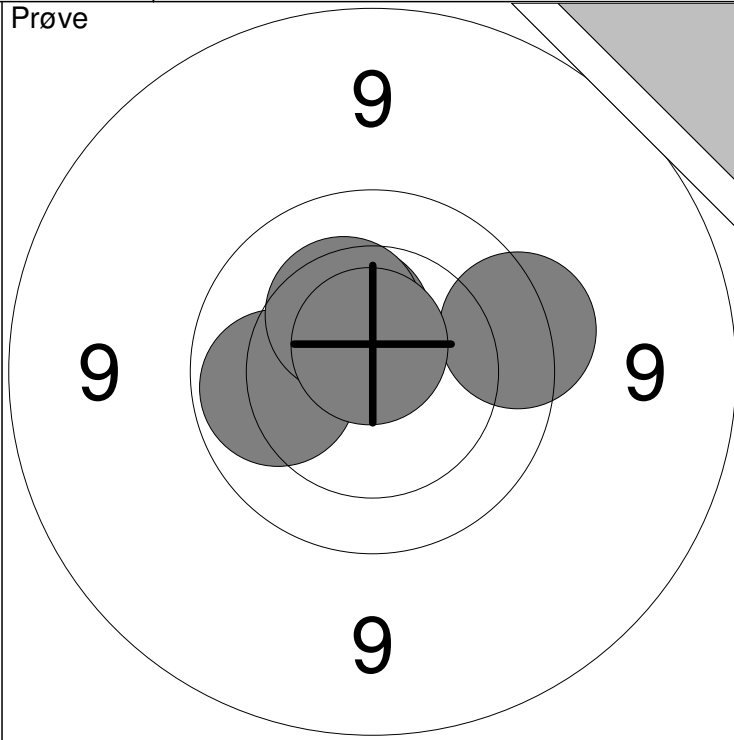

| | |
|-----------|-----------|
| 1: 10.1 ↘ | 6: 9.9 ↘ |
| 2: 9.8 ↑ | 7: 9.9 ↙ |
| 3: 10.1 ↑ | 8: 9.5 ↙ |
| 4: 8.9 ↙ | 9: 9.8 ↑ |
| 5: 9.6 ↘ | 10: 9.7 → |

| | |
|-------|------|
| Serie | 91.0 |
| Total | 0.0 |

| | |
|-------------|------------|
| 11: 10.0 ← | 16: 9.4 → |
| 12: 10.4 ↗ | 17: 10.4 ← |
| 13: 9.7 → | 18: 9.9 ↗ |
| 14: 10.3 ↗ | 19: 9.7 ↑ |
| 15: *10.7 ↑ | 20: 10.0 ↑ |

| | |
|-------|------|
| Serie | 49.0 |
| Total | 0.0 |

20 Skud

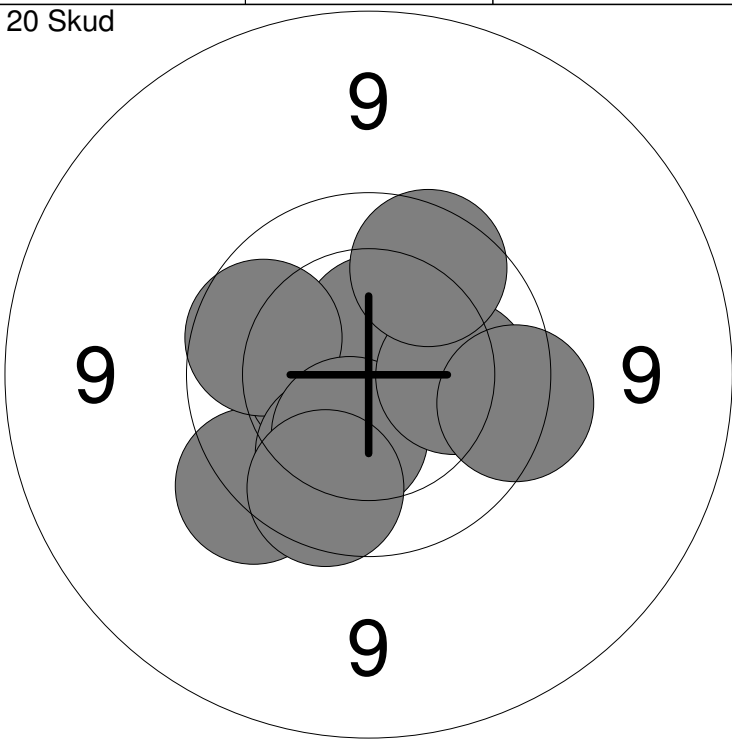

20 Skud

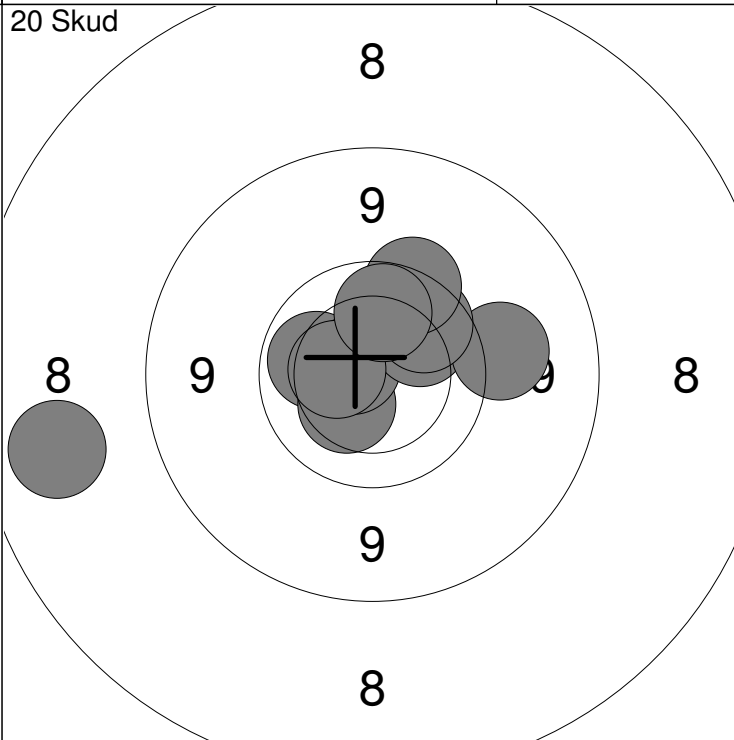

| | |
|------------|-----------|
| 1: 9.6 ↙ | 6: 10.3 ↘ |
| 2: *10.5 ← | 7: 10.1 → |
| 3: *10.5 ↑ | 8: 9.9 ↘ |
| 4: 9.9 ↙ | 9: 9.7 → |
| 5: 10.1 ↘ | 10: 9.8 ↗ |

| | |
|-------|------|
| Serie | 95.0 |
| Total | 95.0 |

| | |
|-------------|------------|
| 11: 8.1 ← | 16: 9.4 → |
| 12: 10.0 ← | 17: 10.4 ← |
| 13: 10.3 ↘ | 18: 9.9 ↗ |
| 14: *10.6 ← | 19: 9.7 ↑ |
| 15: 10.0 ↗ | 20: 10.0 ↑ |

| | |
|-----------|------------|
| 16: 9.4 → | 20: 10.0 ↑ |
|-----------|------------|

| | |
|-------|-------|
| Serie | 95.0 |
| Total | 190.0 |

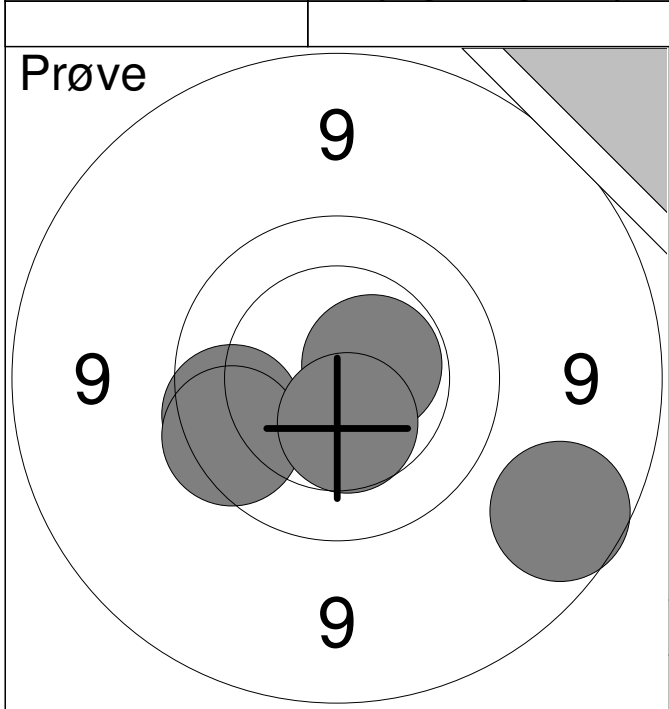

| | | |
|--------------|-------|-------------|
| 1: | 8.9 | ↘ |
| 2: | 9.8 | ↙ |
| 3: | *10.5 | → |
| 4: | 9.8 | ↙ |
| 5: | 10.5 | ↘ |
| Serie | | 46.0 |
| Total | | 0.0 |

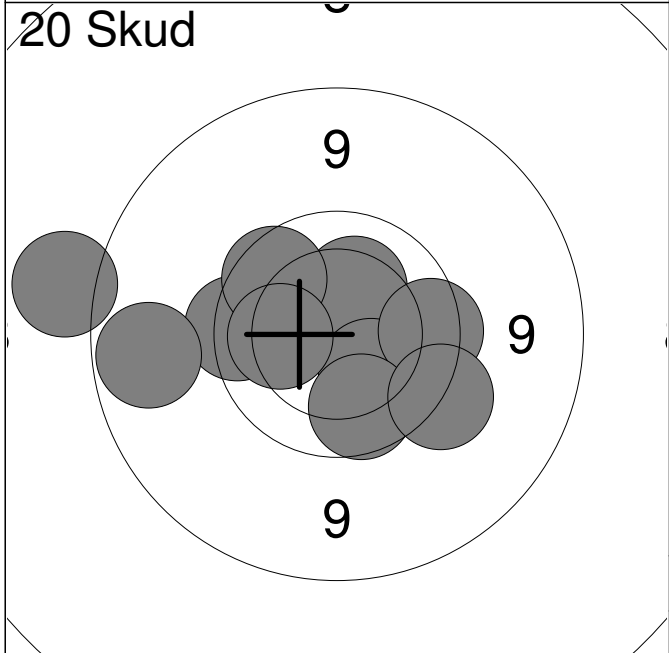

| | | |
|--------------|------|-------------|
| 1: | 8.5 | ↙ |
| 2: | 10.3 | ↗ |
| 3: | 9.7 | ↙ |
| 4: | 9.8 | ↗ |
| 5: | 9.0 | ↙ |
| 6: | 10.2 | ↘ |
| 7: | 9.8 | → |
| 8: | 9.9 | ↘ |
| 9: | 10.1 | ↙ |
| 10: | 9.5 | ↘ |
| Serie | | 92.0 |
| Total | | 92.0 |

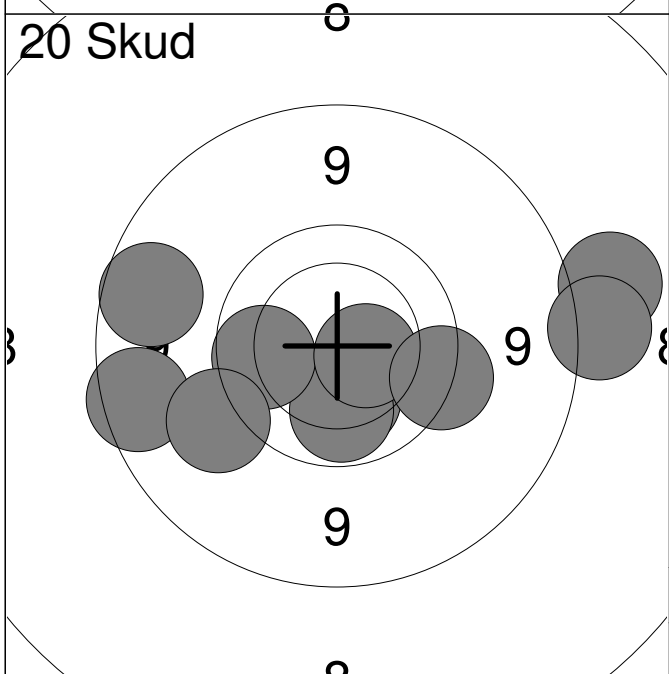

| | | |
|--------------|-------|--------------|
| 11: | 8.9 | ↙ |
| 12: | 10.2 | ↘ |
| 13: | 10.0 | ↘ |
| 14: | 9.9 | ↙ |
| 15: | 8.9 | ↙ |
| 16: | *10.5 | ↗ |
| 17: | 8.5 | → |
| 18: | 9.6 | ↗ |
| 19: | 9.4 | ↙ |
| 20: | 8.6 | → |
| Serie | | 89.0 |
| Total | | 181.0 |

Hold
23

Skive
5

Simon Andersen

Vilsted Skf.

BK1

Prøve

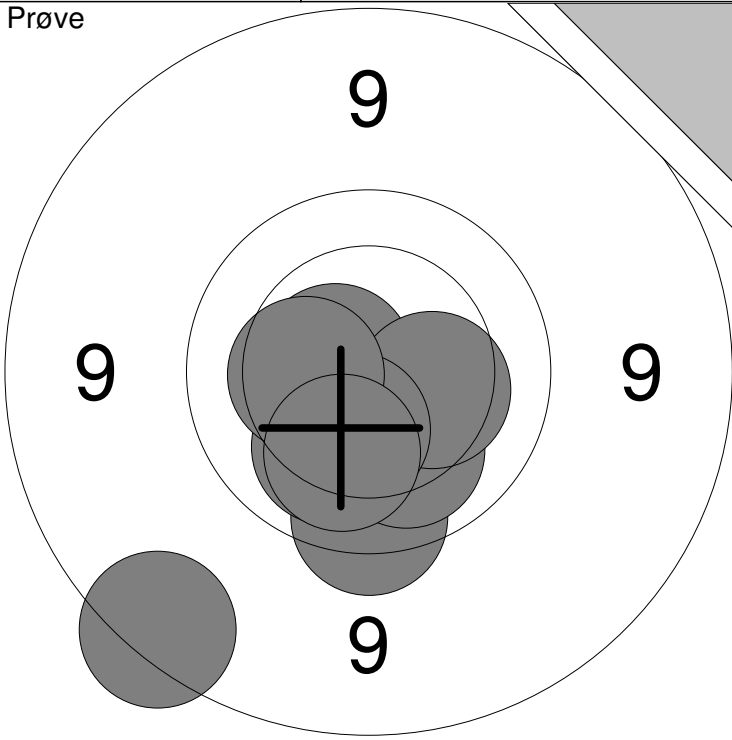

Prøve

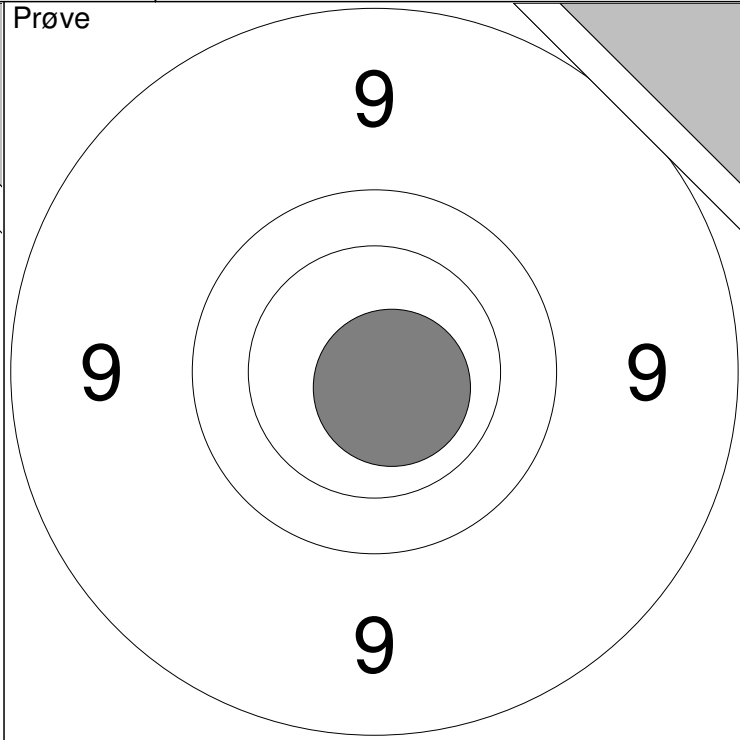

1: 8.8 ↙
 2: 9.7 ↓
 3: *10.6 ↓
 4: 10.1 ↓
 5: *10.6 ←

6: 10.1 ↓
 7: 10.3 →
 8: 10.4 ↓
 9: 10.3 ←
 10: 10.1 ↓

Serie 97.0
 Total 0.0

11: *10.7 ↘

Serie 10.0
 Total 0.0

20 Skud

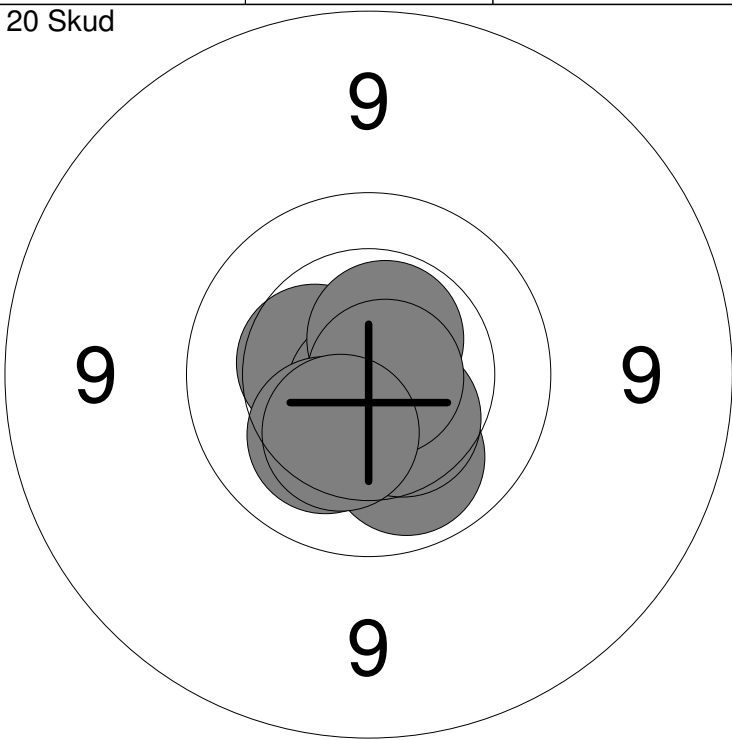

20 Skud

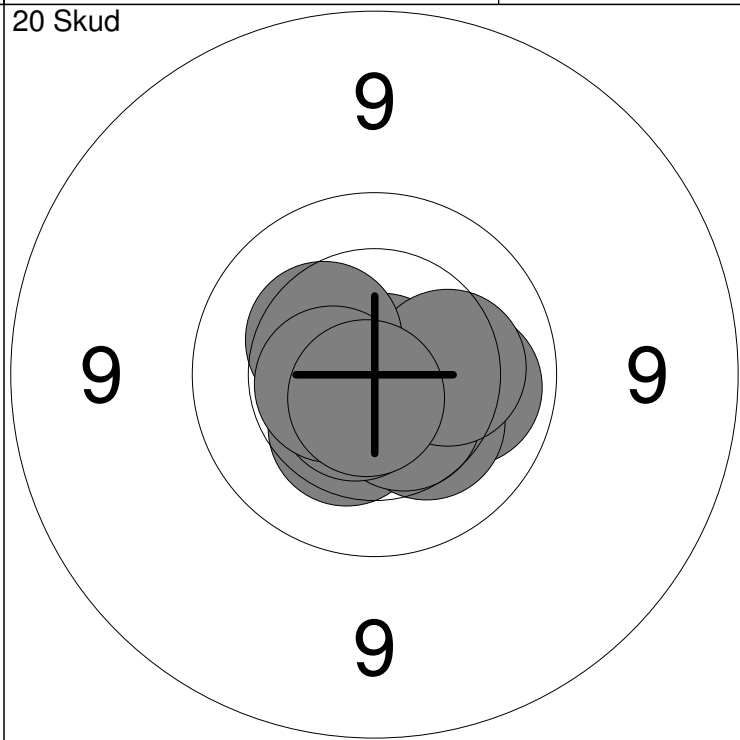

1: 10.4 ←
 2: 10.4 ↓
 3: 10.1 ↓
 4: *10.8 ↓
 5: *10.8 ↓

6: 10.4 ↓
 7: *10.6 ↗
 8: *10.8 →
 9: 10.2 ↓
 10: 10.3 ↓

Serie 100.0
 Total 100.0

11: *10.9 ↗
 12: 10.4 ↓
 13: 10.1 →
 14: 10.3 ↓
 15: 10.5 ↓

16: 10.2 →
 17: 10.4 ↖
 18: *10.6 ↓
 19: *10.5 ←
 20: *10.7 ↓

Serie 100.0
 Total 200.0

| | | | | | | | | | | | | | | | | | | | | |
|---------------------|---|----|-----|---|----|------|---|----|-----|---|----|-----|---|----|------|---|-------|------|-------|-----|
| <p>Prøve</p> | <table style="width:100%; border-collapse: collapse;"> <tr><td style="width:10%;">1:</td><td style="width:15%;">9.8</td><td style="width:10%; text-align: right;">→</td></tr> <tr><td>2:</td><td>10.0</td><td style="text-align: right;">↗</td></tr> <tr><td>3:</td><td>9.8</td><td style="text-align: right;">↑</td></tr> <tr><td>4:</td><td>9.8</td><td style="text-align: right;">↘</td></tr> <tr><td>5:</td><td>10.2</td><td style="text-align: right;">↙</td></tr> </table> <table border="1" style="width:100%; border-collapse: collapse; margin-top: 5px;"> <tr> <td style="width:80%;">Serie</td> <td style="width:20%; text-align: right;">47.0</td> </tr> <tr> <td>Total</td> <td style="text-align: right;">0.0</td> </tr> </table> | 1: | 9.8 | → | 2: | 10.0 | ↗ | 3: | 9.8 | ↑ | 4: | 9.8 | ↘ | 5: | 10.2 | ↙ | Serie | 47.0 | Total | 0.0 |
| 1: | 9.8 | → | | | | | | | | | | | | | | | | | | |
| 2: | 10.0 | ↗ | | | | | | | | | | | | | | | | | | |
| 3: | 9.8 | ↑ | | | | | | | | | | | | | | | | | | |
| 4: | 9.8 | ↘ | | | | | | | | | | | | | | | | | | |
| 5: | 10.2 | ↙ | | | | | | | | | | | | | | | | | | |
| Serie | 47.0 | | | | | | | | | | | | | | | | | | | |
| Total | 0.0 | | | | | | | | | | | | | | | | | | | |

| | | | | | | | | | | | | | | | | | | | | | | | | | | | | | | | | | | | |
|-----------------------|--|----|-----|---|----|-----|---|----|-------|---|----|-------|---|----|-------|---|----|------|---|----|-----|---|----|-----|---|----|-----|---|-----|-----|---|-------|------|-------|------|
| <p>20 Skud</p> | <table style="width:100%; border-collapse: collapse;"> <tr><td style="width:10%;">1:</td><td style="width:15%;">9.4</td><td style="width:10%; text-align: right;">↖</td></tr> <tr><td>2:</td><td>9.9</td><td style="text-align: right;">→</td></tr> <tr><td>3:</td><td>*10.8</td><td style="text-align: right;">↑</td></tr> <tr><td>4:</td><td>*10.6</td><td style="text-align: right;">↓</td></tr> <tr><td>5:</td><td>*10.5</td><td style="text-align: right;">↗</td></tr> <tr><td>6:</td><td>10.0</td><td style="text-align: right;">↖</td></tr> <tr><td>7:</td><td>9.2</td><td style="text-align: right;">↙</td></tr> <tr><td>8:</td><td>9.7</td><td style="text-align: right;">←</td></tr> <tr><td>9:</td><td>9.5</td><td style="text-align: right;">↗</td></tr> <tr><td>10:</td><td>9.7</td><td style="text-align: right;">↖</td></tr> </table> <table border="1" style="width:100%; border-collapse: collapse; margin-top: 5px;"> <tr> <td style="width:80%;">Serie</td> <td style="width:20%; text-align: right;">94.0</td> </tr> <tr> <td>Total</td> <td style="text-align: right;">94.0</td> </tr> </table> | 1: | 9.4 | ↖ | 2: | 9.9 | → | 3: | *10.8 | ↑ | 4: | *10.6 | ↓ | 5: | *10.5 | ↗ | 6: | 10.0 | ↖ | 7: | 9.2 | ↙ | 8: | 9.7 | ← | 9: | 9.5 | ↗ | 10: | 9.7 | ↖ | Serie | 94.0 | Total | 94.0 |
| 1: | 9.4 | ↖ | | | | | | | | | | | | | | | | | | | | | | | | | | | | | | | | | |
| 2: | 9.9 | → | | | | | | | | | | | | | | | | | | | | | | | | | | | | | | | | | |
| 3: | *10.8 | ↑ | | | | | | | | | | | | | | | | | | | | | | | | | | | | | | | | | |
| 4: | *10.6 | ↓ | | | | | | | | | | | | | | | | | | | | | | | | | | | | | | | | | |
| 5: | *10.5 | ↗ | | | | | | | | | | | | | | | | | | | | | | | | | | | | | | | | | |
| 6: | 10.0 | ↖ | | | | | | | | | | | | | | | | | | | | | | | | | | | | | | | | | |
| 7: | 9.2 | ↙ | | | | | | | | | | | | | | | | | | | | | | | | | | | | | | | | | |
| 8: | 9.7 | ← | | | | | | | | | | | | | | | | | | | | | | | | | | | | | | | | | |
| 9: | 9.5 | ↗ | | | | | | | | | | | | | | | | | | | | | | | | | | | | | | | | | |
| 10: | 9.7 | ↖ | | | | | | | | | | | | | | | | | | | | | | | | | | | | | | | | | |
| Serie | 94.0 | | | | | | | | | | | | | | | | | | | | | | | | | | | | | | | | | | |
| Total | 94.0 | | | | | | | | | | | | | | | | | | | | | | | | | | | | | | | | | | |

| | | | | | | | | | | | | | | | | | | | | | | | | | | | | | | | | | | | |
|-----------------------|---|-----|------|---|-----|------|---|-----|------|---|-----|-----|---|-----|-----|---|-----|-----|---|-----|------|---|-----|-----|---|-----|-------|---|-----|-------|---|-------|------|-------|-------|
| <p>20 Skud</p> | <table style="width:100%; border-collapse: collapse;"> <tr><td style="width:10%;">11:</td><td style="width:15%;">10.2</td><td style="width:10%; text-align: right;">↑</td></tr> <tr><td>12:</td><td>10.4</td><td style="text-align: right;">↖</td></tr> <tr><td>13:</td><td>10.4</td><td style="text-align: right;">←</td></tr> <tr><td>14:</td><td>9.9</td><td style="text-align: right;">↑</td></tr> <tr><td>15:</td><td>9.5</td><td style="text-align: right;">←</td></tr> <tr><td>16:</td><td>9.7</td><td style="text-align: right;">↓</td></tr> <tr><td>17:</td><td>10.3</td><td style="text-align: right;">↙</td></tr> <tr><td>18:</td><td>9.8</td><td style="text-align: right;">↗</td></tr> <tr><td>19:</td><td>*10.6</td><td style="text-align: right;">↘</td></tr> <tr><td>20:</td><td>*10.6</td><td style="text-align: right;">↙</td></tr> </table> <table border="1" style="width:100%; border-collapse: collapse; margin-top: 5px;"> <tr> <td style="width:80%;">Serie</td> <td style="width:20%; text-align: right;">96.0</td> </tr> <tr> <td>Total</td> <td style="text-align: right;">190.0</td> </tr> </table> | 11: | 10.2 | ↑ | 12: | 10.4 | ↖ | 13: | 10.4 | ← | 14: | 9.9 | ↑ | 15: | 9.5 | ← | 16: | 9.7 | ↓ | 17: | 10.3 | ↙ | 18: | 9.8 | ↗ | 19: | *10.6 | ↘ | 20: | *10.6 | ↙ | Serie | 96.0 | Total | 190.0 |
| 11: | 10.2 | ↑ | | | | | | | | | | | | | | | | | | | | | | | | | | | | | | | | | |
| 12: | 10.4 | ↖ | | | | | | | | | | | | | | | | | | | | | | | | | | | | | | | | | |
| 13: | 10.4 | ← | | | | | | | | | | | | | | | | | | | | | | | | | | | | | | | | | |
| 14: | 9.9 | ↑ | | | | | | | | | | | | | | | | | | | | | | | | | | | | | | | | | |
| 15: | 9.5 | ← | | | | | | | | | | | | | | | | | | | | | | | | | | | | | | | | | |
| 16: | 9.7 | ↓ | | | | | | | | | | | | | | | | | | | | | | | | | | | | | | | | | |
| 17: | 10.3 | ↙ | | | | | | | | | | | | | | | | | | | | | | | | | | | | | | | | | |
| 18: | 9.8 | ↗ | | | | | | | | | | | | | | | | | | | | | | | | | | | | | | | | | |
| 19: | *10.6 | ↘ | | | | | | | | | | | | | | | | | | | | | | | | | | | | | | | | | |
| 20: | *10.6 | ↙ | | | | | | | | | | | | | | | | | | | | | | | | | | | | | | | | | |
| Serie | 96.0 | | | | | | | | | | | | | | | | | | | | | | | | | | | | | | | | | | |
| Total | 190.0 | | | | | | | | | | | | | | | | | | | | | | | | | | | | | | | | | | |

| | | | | | | | | | | | | | | | | | | | | |
|---------------------|--|----|------|---|----|-------|---|----|-----|---|----|------|---|----|------|---|-------|------|-------|-----|
| <p>Prøve</p> | <table style="width:100%; border-collapse: collapse;"> <tr><td style="width:10%;">1:</td><td style="width:40%;">10.0</td><td style="width:50%; text-align: right;">→</td></tr> <tr><td>2:</td><td>*10.7</td><td style="text-align: right;">↑</td></tr> <tr><td>3:</td><td>9.7</td><td style="text-align: right;">→</td></tr> <tr><td>4:</td><td>10.2</td><td style="text-align: right;">↗</td></tr> <tr><td>5:</td><td>10.3</td><td style="text-align: right;">→</td></tr> </table> <table border="1" style="width:100%; border-collapse: collapse; margin-top: 5px;"> <tr> <td style="width:80%;">Serie</td> <td style="width:20%; text-align: right;">49.0</td> </tr> <tr> <td>Total</td> <td style="text-align: right;">0.0</td> </tr> </table> | 1: | 10.0 | → | 2: | *10.7 | ↑ | 3: | 9.7 | → | 4: | 10.2 | ↗ | 5: | 10.3 | → | Serie | 49.0 | Total | 0.0 |
| 1: | 10.0 | → | | | | | | | | | | | | | | | | | | |
| 2: | *10.7 | ↑ | | | | | | | | | | | | | | | | | | |
| 3: | 9.7 | → | | | | | | | | | | | | | | | | | | |
| 4: | 10.2 | ↗ | | | | | | | | | | | | | | | | | | |
| 5: | 10.3 | → | | | | | | | | | | | | | | | | | | |
| Serie | 49.0 | | | | | | | | | | | | | | | | | | | |
| Total | 0.0 | | | | | | | | | | | | | | | | | | | |

| | | | | | | | | | | | | | | | | | | | | | | | | | | | | | | | | | | | |
|-----------------------|---|----|-------|---|----|------|---|----|-----|---|----|-----|---|----|-------|---|----|------|---|----|-------|---|----|------|---|----|-------|---|-----|------|---|-------|------|-------|------|
| <p>20 Skud</p> | <table style="width:100%; border-collapse: collapse;"> <tr><td style="width:10%;">1:</td><td style="width:40%;">*10.7</td><td style="width:50%; text-align: right;">←</td></tr> <tr><td>2:</td><td>10.5</td><td style="text-align: right;">↑</td></tr> <tr><td>3:</td><td>9.8</td><td style="text-align: right;">→</td></tr> <tr><td>4:</td><td>9.9</td><td style="text-align: right;">→</td></tr> <tr><td>5:</td><td>*10.8</td><td style="text-align: right;">↘</td></tr> <tr><td>6:</td><td>10.0</td><td style="text-align: right;">↗</td></tr> <tr><td>7:</td><td>*10.6</td><td style="text-align: right;">↖</td></tr> <tr><td>8:</td><td>10.4</td><td style="text-align: right;">↗</td></tr> <tr><td>9:</td><td>*10.6</td><td style="text-align: right;">↑</td></tr> <tr><td>10:</td><td>10.1</td><td style="text-align: right;">↘</td></tr> </table> <table border="1" style="width:100%; border-collapse: collapse; margin-top: 5px;"> <tr> <td style="width:80%;">Serie</td> <td style="width:20%; text-align: right;">98.0</td> </tr> <tr> <td>Total</td> <td style="text-align: right;">98.0</td> </tr> </table> | 1: | *10.7 | ← | 2: | 10.5 | ↑ | 3: | 9.8 | → | 4: | 9.9 | → | 5: | *10.8 | ↘ | 6: | 10.0 | ↗ | 7: | *10.6 | ↖ | 8: | 10.4 | ↗ | 9: | *10.6 | ↑ | 10: | 10.1 | ↘ | Serie | 98.0 | Total | 98.0 |
| 1: | *10.7 | ← | | | | | | | | | | | | | | | | | | | | | | | | | | | | | | | | | |
| 2: | 10.5 | ↑ | | | | | | | | | | | | | | | | | | | | | | | | | | | | | | | | | |
| 3: | 9.8 | → | | | | | | | | | | | | | | | | | | | | | | | | | | | | | | | | | |
| 4: | 9.9 | → | | | | | | | | | | | | | | | | | | | | | | | | | | | | | | | | | |
| 5: | *10.8 | ↘ | | | | | | | | | | | | | | | | | | | | | | | | | | | | | | | | | |
| 6: | 10.0 | ↗ | | | | | | | | | | | | | | | | | | | | | | | | | | | | | | | | | |
| 7: | *10.6 | ↖ | | | | | | | | | | | | | | | | | | | | | | | | | | | | | | | | | |
| 8: | 10.4 | ↗ | | | | | | | | | | | | | | | | | | | | | | | | | | | | | | | | | |
| 9: | *10.6 | ↑ | | | | | | | | | | | | | | | | | | | | | | | | | | | | | | | | | |
| 10: | 10.1 | ↘ | | | | | | | | | | | | | | | | | | | | | | | | | | | | | | | | | |
| Serie | 98.0 | | | | | | | | | | | | | | | | | | | | | | | | | | | | | | | | | | |
| Total | 98.0 | | | | | | | | | | | | | | | | | | | | | | | | | | | | | | | | | | |

| | | | | | | | | | | | | | | | | | | | | | | | | | | | | | | | | | | | |
|-----------------------|--|-----|-------|---|-----|-----|---|-----|------|---|-----|-------|---|-----|------|---|-----|------|---|-----|------|---|-----|-----|---|-----|-------|---|-----|------|---|-------|------|-------|-------|
| <p>20 Skud</p> | <table style="width:100%; border-collapse: collapse;"> <tr><td style="width:10%;">11:</td><td style="width:40%;">*10.8</td><td style="width:50%; text-align: right;">↗</td></tr> <tr><td>12:</td><td>9.9</td><td style="text-align: right;">→</td></tr> <tr><td>13:</td><td>10.2</td><td style="text-align: right;">↘</td></tr> <tr><td>14:</td><td>*10.8</td><td style="text-align: right;">↗</td></tr> <tr><td>15:</td><td>10.0</td><td style="text-align: right;">→</td></tr> <tr><td>16:</td><td>10.1</td><td style="text-align: right;">↗</td></tr> <tr><td>17:</td><td>10.5</td><td style="text-align: right;">↘</td></tr> <tr><td>18:</td><td>9.9</td><td style="text-align: right;">←</td></tr> <tr><td>19:</td><td>*10.5</td><td style="text-align: right;">↘</td></tr> <tr><td>20:</td><td>10.2</td><td style="text-align: right;">↘</td></tr> </table> <table border="1" style="width:100%; border-collapse: collapse; margin-top: 5px;"> <tr> <td style="width:80%;">Serie</td> <td style="width:20%; text-align: right;">98.0</td> </tr> <tr> <td>Total</td> <td style="text-align: right;">196.0</td> </tr> </table> | 11: | *10.8 | ↗ | 12: | 9.9 | → | 13: | 10.2 | ↘ | 14: | *10.8 | ↗ | 15: | 10.0 | → | 16: | 10.1 | ↗ | 17: | 10.5 | ↘ | 18: | 9.9 | ← | 19: | *10.5 | ↘ | 20: | 10.2 | ↘ | Serie | 98.0 | Total | 196.0 |
| 11: | *10.8 | ↗ | | | | | | | | | | | | | | | | | | | | | | | | | | | | | | | | | |
| 12: | 9.9 | → | | | | | | | | | | | | | | | | | | | | | | | | | | | | | | | | | |
| 13: | 10.2 | ↘ | | | | | | | | | | | | | | | | | | | | | | | | | | | | | | | | | |
| 14: | *10.8 | ↗ | | | | | | | | | | | | | | | | | | | | | | | | | | | | | | | | | |
| 15: | 10.0 | → | | | | | | | | | | | | | | | | | | | | | | | | | | | | | | | | | |
| 16: | 10.1 | ↗ | | | | | | | | | | | | | | | | | | | | | | | | | | | | | | | | | |
| 17: | 10.5 | ↘ | | | | | | | | | | | | | | | | | | | | | | | | | | | | | | | | | |
| 18: | 9.9 | ← | | | | | | | | | | | | | | | | | | | | | | | | | | | | | | | | | |
| 19: | *10.5 | ↘ | | | | | | | | | | | | | | | | | | | | | | | | | | | | | | | | | |
| 20: | 10.2 | ↘ | | | | | | | | | | | | | | | | | | | | | | | | | | | | | | | | | |
| Serie | 98.0 | | | | | | | | | | | | | | | | | | | | | | | | | | | | | | | | | | |
| Total | 196.0 | | | | | | | | | | | | | | | | | | | | | | | | | | | | | | | | | | |

Hold
23

Skive
8

Thomas Serup Hautopp

Vadum Skf.

BK2

Prøve

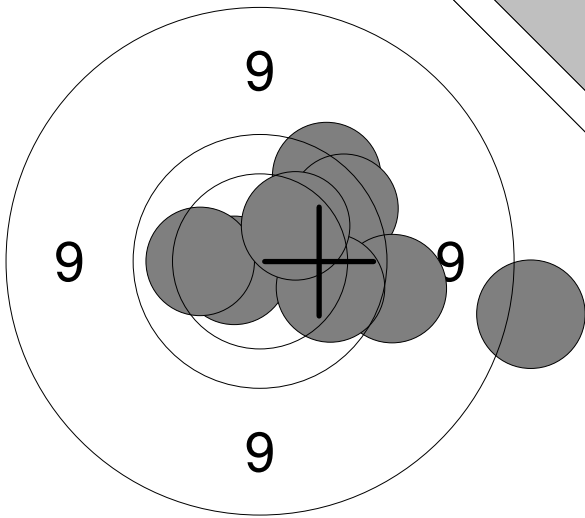

| | | |
|----|-------|---|
| 1: | 8.6 | → |
| 2: | *10.6 | ← |
| 3: | 9.7 | ↗ |
| 4: | 9.7 | ↗ |
| 5: | 9.5 | → |
| 6: | 9.9 | → |
| 7: | 10.1 | ← |
| 8: | 10.3 | ↗ |

Serie 74.0

Total 0.0

20 Skud

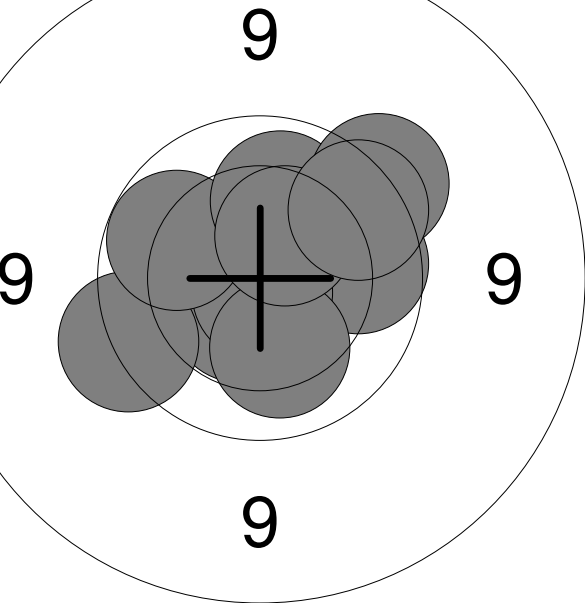

| | | |
|-----|-------|---|
| 1: | 9.9 | → |
| 2: | *10.5 | ↙ |
| 3: | *10.8 | ↓ |
| 4: | 9.6 | ← |
| 5: | 10.2 | ↓ |
| 6: | 10.0 | ↖ |
| 7: | 10.1 | ↗ |
| 8: | 10.4 | ↗ |
| 9: | 9.6 | ↗ |
| 10: | 9.8 | ↗ |

Serie 96.0

Total 96.0

20 Skud

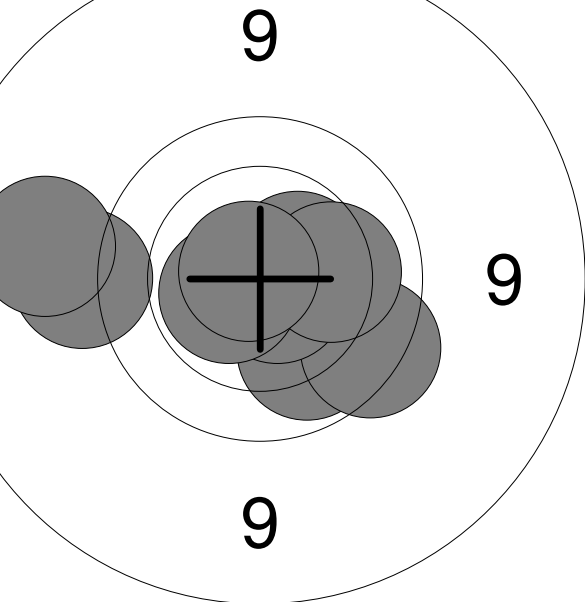

| | | |
|-----|-------|---|
| 11: | *10.5 | ↗ |
| 12: | 10.4 | → |
| 13: | 9.4 | ← |
| 14: | 10.0 | ↙ |
| 15: | 9.7 | ↙ |
| 16: | 9.2 | ← |
| 17: | *10.7 | ↙ |
| 18: | 10.2 | → |
| 19: | *10.6 | ← |
| 20: | *10.8 | ↗ |

Serie 97.0

Total 193.0

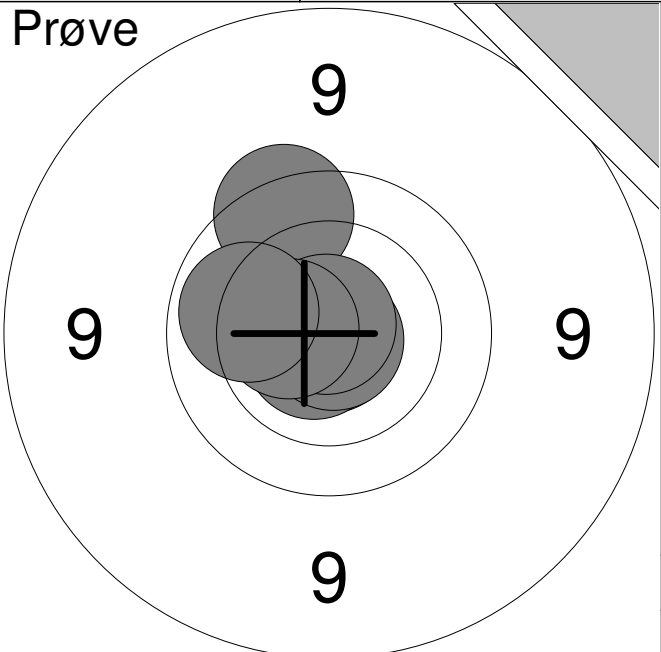
| | | | | | | | | | | | | | | | | | | | | | | | | | | |
|--|---|----|-------|---|----|-------|---|----|-----|---|----|-------|---|----|-------|---|----|-------|---|----|------|---|-------|------|-------|-----|
| <p>Prøve</p>  | <table style="width:100%; border-collapse: collapse;"> <tr><td style="width:10%;">1:</td><td style="width:15%;">*10.8</td><td style="width:10%; text-align: right;">↓</td></tr> <tr><td>2:</td><td>*10.7</td><td style="text-align: right;">↖</td></tr> <tr><td>3:</td><td>9.7</td><td style="text-align: right;">↗</td></tr> <tr><td>4:</td><td>*10.9</td><td style="text-align: right;">↓</td></tr> <tr><td>5:</td><td>*10.8</td><td style="text-align: right;">↗</td></tr> <tr><td>6:</td><td>*10.5</td><td style="text-align: right;">↖</td></tr> <tr><td>7:</td><td>10.1</td><td style="text-align: right;">↖</td></tr> </table> <table border="1" style="width:100%; border-collapse: collapse; margin-top: 5px;"> <tr> <td style="width:80%;">Serie</td> <td style="text-align: right;">69.0</td> </tr> <tr> <td>Total</td> <td style="text-align: right;">0.0</td> </tr> </table> | 1: | *10.8 | ↓ | 2: | *10.7 | ↖ | 3: | 9.7 | ↗ | 4: | *10.9 | ↓ | 5: | *10.8 | ↗ | 6: | *10.5 | ↖ | 7: | 10.1 | ↖ | Serie | 69.0 | Total | 0.0 |
| 1: | *10.8 | ↓ | | | | | | | | | | | | | | | | | | | | | | | | |
| 2: | *10.7 | ↖ | | | | | | | | | | | | | | | | | | | | | | | | |
| 3: | 9.7 | ↗ | | | | | | | | | | | | | | | | | | | | | | | | |
| 4: | *10.9 | ↓ | | | | | | | | | | | | | | | | | | | | | | | | |
| 5: | *10.8 | ↗ | | | | | | | | | | | | | | | | | | | | | | | | |
| 6: | *10.5 | ↖ | | | | | | | | | | | | | | | | | | | | | | | | |
| 7: | 10.1 | ↖ | | | | | | | | | | | | | | | | | | | | | | | | |
| Serie | 69.0 | | | | | | | | | | | | | | | | | | | | | | | | | |
| Total | 0.0 | | | | | | | | | | | | | | | | | | | | | | | | | |

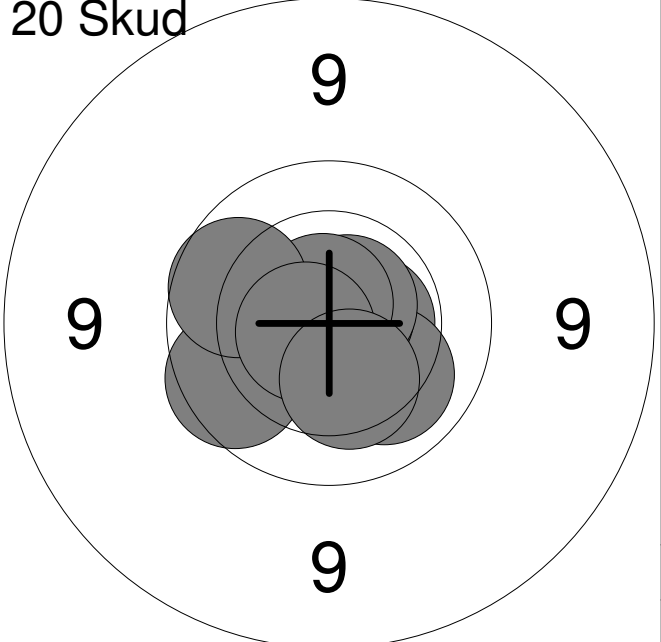
| | | | | | | | | | | | | | | | | | | | | | | | | | | | | | | | | | | | |
|---|---|----|------|---|----|-------|---|----|------|---|----|-------|---|----|-------|---|----|-----|---|----|-------|---|----|-----|---|----|-------|---|-----|------|---|-------|------|-------|------|
| <p>20 Skud</p>  | <table style="width:100%; border-collapse: collapse;"> <tr><td style="width:10%;">1:</td><td style="width:15%;">10.4</td><td style="width:10%; text-align: right;">↓</td></tr> <tr><td>2:</td><td>*10.6</td><td style="text-align: right;">→</td></tr> <tr><td>3:</td><td>10.1</td><td style="text-align: right;">↓</td></tr> <tr><td>4:</td><td>*10.8</td><td style="text-align: right;">↗</td></tr> <tr><td>5:</td><td>*10.7</td><td style="text-align: right;">↗</td></tr> <tr><td>6:</td><td>9.9</td><td style="text-align: right;">↖</td></tr> <tr><td>7:</td><td>*10.7</td><td style="text-align: right;">↗</td></tr> <tr><td>8:</td><td>9.9</td><td style="text-align: right;">↖</td></tr> <tr><td>9:</td><td>*10.7</td><td style="text-align: right;">↖</td></tr> <tr><td>10:</td><td>10.3</td><td style="text-align: right;">↓</td></tr> </table> <table border="1" style="width:100%; border-collapse: collapse; margin-top: 5px;"> <tr> <td style="width:80%;">Serie</td> <td style="text-align: right;">98.0</td> </tr> <tr> <td>Total</td> <td style="text-align: right;">98.0</td> </tr> </table> | 1: | 10.4 | ↓ | 2: | *10.6 | → | 3: | 10.1 | ↓ | 4: | *10.8 | ↗ | 5: | *10.7 | ↗ | 6: | 9.9 | ↖ | 7: | *10.7 | ↗ | 8: | 9.9 | ↖ | 9: | *10.7 | ↖ | 10: | 10.3 | ↓ | Serie | 98.0 | Total | 98.0 |
| 1: | 10.4 | ↓ | | | | | | | | | | | | | | | | | | | | | | | | | | | | | | | | | |
| 2: | *10.6 | → | | | | | | | | | | | | | | | | | | | | | | | | | | | | | | | | | |
| 3: | 10.1 | ↓ | | | | | | | | | | | | | | | | | | | | | | | | | | | | | | | | | |
| 4: | *10.8 | ↗ | | | | | | | | | | | | | | | | | | | | | | | | | | | | | | | | | |
| 5: | *10.7 | ↗ | | | | | | | | | | | | | | | | | | | | | | | | | | | | | | | | | |
| 6: | 9.9 | ↖ | | | | | | | | | | | | | | | | | | | | | | | | | | | | | | | | | |
| 7: | *10.7 | ↗ | | | | | | | | | | | | | | | | | | | | | | | | | | | | | | | | | |
| 8: | 9.9 | ↖ | | | | | | | | | | | | | | | | | | | | | | | | | | | | | | | | | |
| 9: | *10.7 | ↖ | | | | | | | | | | | | | | | | | | | | | | | | | | | | | | | | | |
| 10: | 10.3 | ↓ | | | | | | | | | | | | | | | | | | | | | | | | | | | | | | | | | |
| Serie | 98.0 | | | | | | | | | | | | | | | | | | | | | | | | | | | | | | | | | | |
| Total | 98.0 | | | | | | | | | | | | | | | | | | | | | | | | | | | | | | | | | | |

| | | | | | | | | | | | | | | | | | | | | | | | | | | | | | | | | | | | |
|--|--|-----|-------|---|-----|------|---|-----|------|---|-----|-----|---|-----|-------|---|-----|------|---|-----|------|---|-----|------|---|-----|-----|---|-----|------|---|-------|------|-------|-------|
| <p>20 Skud</p>  | <table style="width:100%; border-collapse: collapse;"> <tr><td style="width:10%;">11:</td><td style="width:15%;">*10.5</td><td style="width:10%; text-align: right;">↗</td></tr> <tr><td>12:</td><td>10.2</td><td style="text-align: right;">↓</td></tr> <tr><td>13:</td><td>10.1</td><td style="text-align: right;">↓</td></tr> <tr><td>14:</td><td>9.9</td><td style="text-align: right;">↗</td></tr> <tr><td>15:</td><td>*10.6</td><td style="text-align: right;">↗</td></tr> <tr><td>16:</td><td>10.1</td><td style="text-align: right;">→</td></tr> <tr><td>17:</td><td>10.5</td><td style="text-align: right;">↓</td></tr> <tr><td>18:</td><td>10.5</td><td style="text-align: right;">→</td></tr> <tr><td>19:</td><td>9.9</td><td style="text-align: right;">↗</td></tr> <tr><td>20:</td><td>10.4</td><td style="text-align: right;">↗</td></tr> </table> <table border="1" style="width:100%; border-collapse: collapse; margin-top: 5px;"> <tr> <td style="width:80%;">Serie</td> <td style="text-align: right;">98.0</td> </tr> <tr> <td>Total</td> <td style="text-align: right;">196.0</td> </tr> </table> | 11: | *10.5 | ↗ | 12: | 10.2 | ↓ | 13: | 10.1 | ↓ | 14: | 9.9 | ↗ | 15: | *10.6 | ↗ | 16: | 10.1 | → | 17: | 10.5 | ↓ | 18: | 10.5 | → | 19: | 9.9 | ↗ | 20: | 10.4 | ↗ | Serie | 98.0 | Total | 196.0 |
| 11: | *10.5 | ↗ | | | | | | | | | | | | | | | | | | | | | | | | | | | | | | | | | |
| 12: | 10.2 | ↓ | | | | | | | | | | | | | | | | | | | | | | | | | | | | | | | | | |
| 13: | 10.1 | ↓ | | | | | | | | | | | | | | | | | | | | | | | | | | | | | | | | | |
| 14: | 9.9 | ↗ | | | | | | | | | | | | | | | | | | | | | | | | | | | | | | | | | |
| 15: | *10.6 | ↗ | | | | | | | | | | | | | | | | | | | | | | | | | | | | | | | | | |
| 16: | 10.1 | → | | | | | | | | | | | | | | | | | | | | | | | | | | | | | | | | | |
| 17: | 10.5 | ↓ | | | | | | | | | | | | | | | | | | | | | | | | | | | | | | | | | |
| 18: | 10.5 | → | | | | | | | | | | | | | | | | | | | | | | | | | | | | | | | | | |
| 19: | 9.9 | ↗ | | | | | | | | | | | | | | | | | | | | | | | | | | | | | | | | | |
| 20: | 10.4 | ↗ | | | | | | | | | | | | | | | | | | | | | | | | | | | | | | | | | |
| Serie | 98.0 | | | | | | | | | | | | | | | | | | | | | | | | | | | | | | | | | | |
| Total | 196.0 | | | | | | | | | | | | | | | | | | | | | | | | | | | | | | | | | | |

| | | | | | | | | | | | | | | | | | | | | |
|---------------------|---|----|------|---|----|------|---|----|-------|---|----|------|---|----|------|---|-------|------|-------|-----|
| <p>Prøve</p> | <table style="width:100%; border-collapse: collapse;"> <tr><td style="width:10%;">1:</td><td style="width:40%;">10.1</td><td style="width:50%; text-align: right;">↘</td></tr> <tr><td>2:</td><td>10.3</td><td style="text-align: right;">↗</td></tr> <tr><td>3:</td><td>*10.5</td><td style="text-align: right;">↘</td></tr> <tr><td>4:</td><td>10.4</td><td style="text-align: right;">↘</td></tr> <tr><td>5:</td><td>10.0</td><td style="text-align: right;">→</td></tr> </table> <table border="1" style="width:100%; border-collapse: collapse; margin-top: 5px;"> <tr> <td style="width:80%;">Serie</td> <td style="width:20%; text-align: right;">50.0</td> </tr> <tr> <td>Total</td> <td style="text-align: right;">0.0</td> </tr> </table> | 1: | 10.1 | ↘ | 2: | 10.3 | ↗ | 3: | *10.5 | ↘ | 4: | 10.4 | ↘ | 5: | 10.0 | → | Serie | 50.0 | Total | 0.0 |
| 1: | 10.1 | ↘ | | | | | | | | | | | | | | | | | | |
| 2: | 10.3 | ↗ | | | | | | | | | | | | | | | | | | |
| 3: | *10.5 | ↘ | | | | | | | | | | | | | | | | | | |
| 4: | 10.4 | ↘ | | | | | | | | | | | | | | | | | | |
| 5: | 10.0 | → | | | | | | | | | | | | | | | | | | |
| Serie | 50.0 | | | | | | | | | | | | | | | | | | | |
| Total | 0.0 | | | | | | | | | | | | | | | | | | | |

| | | | | | | | | | | | | | | | | | | | | | | | | | | | | | | | | | | | |
|-----------------------|--|----|-------|---|----|------|---|----|------|---|----|-----|---|----|-----|---|----|------|---|----|------|---|----|-------|---|----|-------|---|-----|------|---|-------|------|-------|------|
| <p>20 Skud</p> | <table style="width:100%; border-collapse: collapse;"> <tr><td style="width:10%;">1:</td><td style="width:40%;">*10.6</td><td style="width:50%; text-align: right;">↘</td></tr> <tr><td>2:</td><td>10.2</td><td style="text-align: right;">→</td></tr> <tr><td>3:</td><td>10.1</td><td style="text-align: right;">→</td></tr> <tr><td>4:</td><td>9.7</td><td style="text-align: right;">↗</td></tr> <tr><td>5:</td><td>9.6</td><td style="text-align: right;">↗</td></tr> <tr><td>6:</td><td>10.0</td><td style="text-align: right;">↘</td></tr> <tr><td>7:</td><td>10.3</td><td style="text-align: right;">↘</td></tr> <tr><td>8:</td><td>*10.7</td><td style="text-align: right;">↗</td></tr> <tr><td>9:</td><td>*10.5</td><td style="text-align: right;">↘</td></tr> <tr><td>10:</td><td>10.0</td><td style="text-align: right;">↘</td></tr> </table> <table border="1" style="width:100%; border-collapse: collapse; margin-top: 5px;"> <tr> <td style="width:80%;">Serie</td> <td style="width:20%; text-align: right;">98.0</td> </tr> <tr> <td>Total</td> <td style="text-align: right;">98.0</td> </tr> </table> | 1: | *10.6 | ↘ | 2: | 10.2 | → | 3: | 10.1 | → | 4: | 9.7 | ↗ | 5: | 9.6 | ↗ | 6: | 10.0 | ↘ | 7: | 10.3 | ↘ | 8: | *10.7 | ↗ | 9: | *10.5 | ↘ | 10: | 10.0 | ↘ | Serie | 98.0 | Total | 98.0 |
| 1: | *10.6 | ↘ | | | | | | | | | | | | | | | | | | | | | | | | | | | | | | | | | |
| 2: | 10.2 | → | | | | | | | | | | | | | | | | | | | | | | | | | | | | | | | | | |
| 3: | 10.1 | → | | | | | | | | | | | | | | | | | | | | | | | | | | | | | | | | | |
| 4: | 9.7 | ↗ | | | | | | | | | | | | | | | | | | | | | | | | | | | | | | | | | |
| 5: | 9.6 | ↗ | | | | | | | | | | | | | | | | | | | | | | | | | | | | | | | | | |
| 6: | 10.0 | ↘ | | | | | | | | | | | | | | | | | | | | | | | | | | | | | | | | | |
| 7: | 10.3 | ↘ | | | | | | | | | | | | | | | | | | | | | | | | | | | | | | | | | |
| 8: | *10.7 | ↗ | | | | | | | | | | | | | | | | | | | | | | | | | | | | | | | | | |
| 9: | *10.5 | ↘ | | | | | | | | | | | | | | | | | | | | | | | | | | | | | | | | | |
| 10: | 10.0 | ↘ | | | | | | | | | | | | | | | | | | | | | | | | | | | | | | | | | |
| Serie | 98.0 | | | | | | | | | | | | | | | | | | | | | | | | | | | | | | | | | | |
| Total | 98.0 | | | | | | | | | | | | | | | | | | | | | | | | | | | | | | | | | | |

| | | | | | | | | | | | | | | | | | | | | | | | | | | | | | | | | | | | |
|-----------------------|--|-----|-------|---|-----|------|---|-----|-----|---|-----|-------|---|-----|-----|---|-----|-----|---|-----|------|---|-----|------|---|-----|-----|---|-----|-------|---|-------|------|-------|-------|
| <p>20 Skud</p> | <table style="width:100%; border-collapse: collapse;"> <tr><td style="width:10%;">11:</td><td style="width:40%;">*10.7</td><td style="width:50%; text-align: right;">←</td></tr> <tr><td>12:</td><td>10.0</td><td style="text-align: right;">↗</td></tr> <tr><td>13:</td><td>9.9</td><td style="text-align: right;">↑</td></tr> <tr><td>14:</td><td>*10.9</td><td style="text-align: right;">↘</td></tr> <tr><td>15:</td><td>9.8</td><td style="text-align: right;">↘</td></tr> <tr><td>16:</td><td>9.8</td><td style="text-align: right;">↗</td></tr> <tr><td>17:</td><td>10.1</td><td style="text-align: right;">↘</td></tr> <tr><td>18:</td><td>10.1</td><td style="text-align: right;">↗</td></tr> <tr><td>19:</td><td>9.6</td><td style="text-align: right;">↗</td></tr> <tr><td>20:</td><td>*10.9</td><td style="text-align: right;">↗</td></tr> </table> <table border="1" style="width:100%; border-collapse: collapse; margin-top: 5px;"> <tr> <td style="width:80%;">Serie</td> <td style="width:20%; text-align: right;">96.0</td> </tr> <tr> <td>Total</td> <td style="text-align: right;">194.0</td> </tr> </table> | 11: | *10.7 | ← | 12: | 10.0 | ↗ | 13: | 9.9 | ↑ | 14: | *10.9 | ↘ | 15: | 9.8 | ↘ | 16: | 9.8 | ↗ | 17: | 10.1 | ↘ | 18: | 10.1 | ↗ | 19: | 9.6 | ↗ | 20: | *10.9 | ↗ | Serie | 96.0 | Total | 194.0 |
| 11: | *10.7 | ← | | | | | | | | | | | | | | | | | | | | | | | | | | | | | | | | | |
| 12: | 10.0 | ↗ | | | | | | | | | | | | | | | | | | | | | | | | | | | | | | | | | |
| 13: | 9.9 | ↑ | | | | | | | | | | | | | | | | | | | | | | | | | | | | | | | | | |
| 14: | *10.9 | ↘ | | | | | | | | | | | | | | | | | | | | | | | | | | | | | | | | | |
| 15: | 9.8 | ↘ | | | | | | | | | | | | | | | | | | | | | | | | | | | | | | | | | |
| 16: | 9.8 | ↗ | | | | | | | | | | | | | | | | | | | | | | | | | | | | | | | | | |
| 17: | 10.1 | ↘ | | | | | | | | | | | | | | | | | | | | | | | | | | | | | | | | | |
| 18: | 10.1 | ↗ | | | | | | | | | | | | | | | | | | | | | | | | | | | | | | | | | |
| 19: | 9.6 | ↗ | | | | | | | | | | | | | | | | | | | | | | | | | | | | | | | | | |
| 20: | *10.9 | ↗ | | | | | | | | | | | | | | | | | | | | | | | | | | | | | | | | | |
| Serie | 96.0 | | | | | | | | | | | | | | | | | | | | | | | | | | | | | | | | | | |
| Total | 194.0 | | | | | | | | | | | | | | | | | | | | | | | | | | | | | | | | | | |

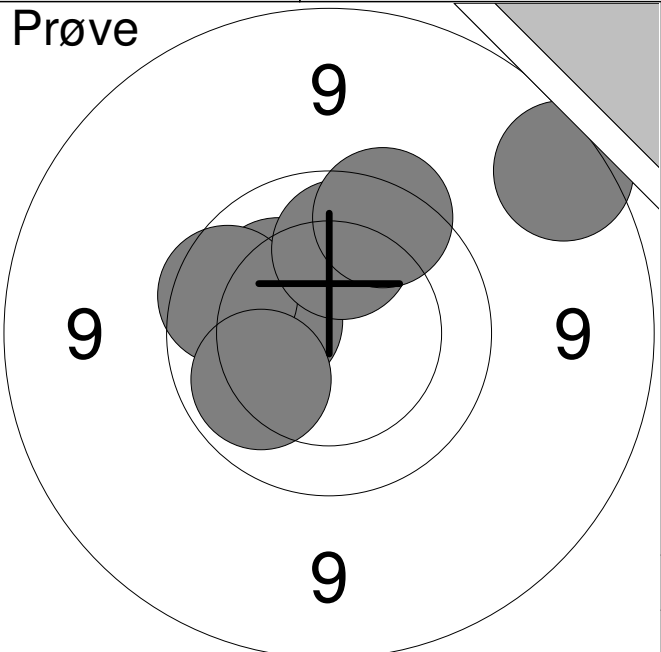
| | | | | | | | | | | | | | | | | | | | | | | | | | | |
|--|---|----|------|---|----|------|---|----|-----|---|----|-----|---|----|------|---|----|-----|---|----|------|---|-------|------|-------|-----|
| <p>Prøve</p>  | <table style="width:100%; border-collapse: collapse;"> <tr><td style="width:10%;">1:</td><td style="width:15%;">10.2</td><td style="width:10%; text-align: center;">↗</td></tr> <tr><td>2:</td><td>10.3</td><td style="text-align: center;">↖</td></tr> <tr><td>3:</td><td>9.9</td><td style="text-align: center;">↖</td></tr> <tr><td>4:</td><td>8.8</td><td style="text-align: center;">↗</td></tr> <tr><td>5:</td><td>10.0</td><td style="text-align: center;">↑</td></tr> <tr><td>6:</td><td>9.7</td><td style="text-align: center;">↗</td></tr> <tr><td>7:</td><td>10.1</td><td style="text-align: center;">↙</td></tr> </table> <table border="1" style="width:100%; border-collapse: collapse; margin-top: 5px;"> <tr> <td style="width:80%;">Serie</td> <td style="text-align: right;">66.0</td> </tr> <tr> <td>Total</td> <td style="text-align: right;">0.0</td> </tr> </table> | 1: | 10.2 | ↗ | 2: | 10.3 | ↖ | 3: | 9.9 | ↖ | 4: | 8.8 | ↗ | 5: | 10.0 | ↑ | 6: | 9.7 | ↗ | 7: | 10.1 | ↙ | Serie | 66.0 | Total | 0.0 |
| 1: | 10.2 | ↗ | | | | | | | | | | | | | | | | | | | | | | | | |
| 2: | 10.3 | ↖ | | | | | | | | | | | | | | | | | | | | | | | | |
| 3: | 9.9 | ↖ | | | | | | | | | | | | | | | | | | | | | | | | |
| 4: | 8.8 | ↗ | | | | | | | | | | | | | | | | | | | | | | | | |
| 5: | 10.0 | ↑ | | | | | | | | | | | | | | | | | | | | | | | | |
| 6: | 9.7 | ↗ | | | | | | | | | | | | | | | | | | | | | | | | |
| 7: | 10.1 | ↙ | | | | | | | | | | | | | | | | | | | | | | | | |
| Serie | 66.0 | | | | | | | | | | | | | | | | | | | | | | | | | |
| Total | 0.0 | | | | | | | | | | | | | | | | | | | | | | | | | |

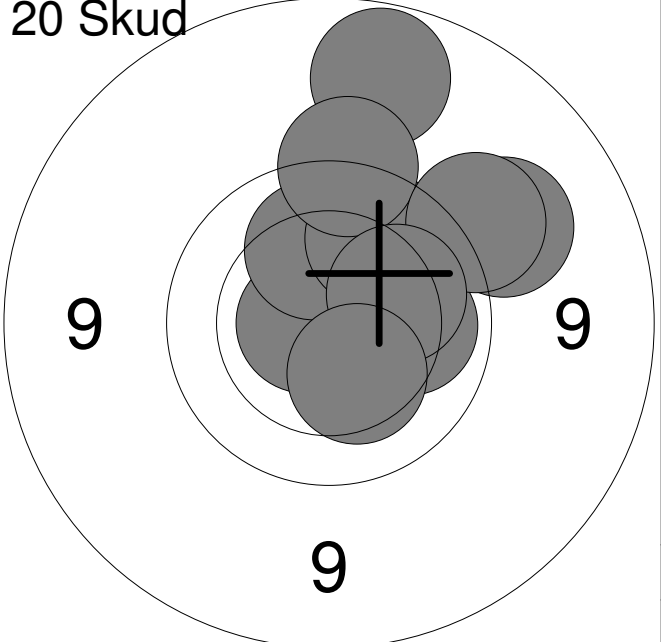
| | | | | | | | | | | | | | | | | | | | | | | | | | | | | | | | | | | | |
|---|--|----|-----|---|----|-------|---|----|------|---|----|------|---|----|-----|---|----|-----|---|----|-----|---|----|-----|---|----|------|---|-----|------|---|-------|------|-------|------|
| <p>20 Skud</p>  | <table style="width:100%; border-collapse: collapse;"> <tr><td style="width:10%;">1:</td><td style="width:15%;">9.0</td><td style="width:10%; text-align: center;">↑</td></tr> <tr><td>2:</td><td>*10.7</td><td style="text-align: center;">↖</td></tr> <tr><td>3:</td><td>10.1</td><td style="text-align: center;">→</td></tr> <tr><td>4:</td><td>10.1</td><td style="text-align: center;">↑</td></tr> <tr><td>5:</td><td>9.9</td><td style="text-align: center;">↗</td></tr> <tr><td>6:</td><td>9.6</td><td style="text-align: center;">↑</td></tr> <tr><td>7:</td><td>9.3</td><td style="text-align: center;">↗</td></tr> <tr><td>8:</td><td>9.4</td><td style="text-align: center;">↗</td></tr> <tr><td>9:</td><td>10.2</td><td style="text-align: center;">→</td></tr> <tr><td>10:</td><td>10.3</td><td style="text-align: center;">↓</td></tr> </table> <table border="1" style="width:100%; border-collapse: collapse; margin-top: 5px;"> <tr> <td style="width:80%;">Serie</td> <td style="text-align: right;">95.0</td> </tr> <tr> <td>Total</td> <td style="text-align: right;">95.0</td> </tr> </table> | 1: | 9.0 | ↑ | 2: | *10.7 | ↖ | 3: | 10.1 | → | 4: | 10.1 | ↑ | 5: | 9.9 | ↗ | 6: | 9.6 | ↑ | 7: | 9.3 | ↗ | 8: | 9.4 | ↗ | 9: | 10.2 | → | 10: | 10.3 | ↓ | Serie | 95.0 | Total | 95.0 |
| 1: | 9.0 | ↑ | | | | | | | | | | | | | | | | | | | | | | | | | | | | | | | | | |
| 2: | *10.7 | ↖ | | | | | | | | | | | | | | | | | | | | | | | | | | | | | | | | | |
| 3: | 10.1 | → | | | | | | | | | | | | | | | | | | | | | | | | | | | | | | | | | |
| 4: | 10.1 | ↑ | | | | | | | | | | | | | | | | | | | | | | | | | | | | | | | | | |
| 5: | 9.9 | ↗ | | | | | | | | | | | | | | | | | | | | | | | | | | | | | | | | | |
| 6: | 9.6 | ↑ | | | | | | | | | | | | | | | | | | | | | | | | | | | | | | | | | |
| 7: | 9.3 | ↗ | | | | | | | | | | | | | | | | | | | | | | | | | | | | | | | | | |
| 8: | 9.4 | ↗ | | | | | | | | | | | | | | | | | | | | | | | | | | | | | | | | | |
| 9: | 10.2 | → | | | | | | | | | | | | | | | | | | | | | | | | | | | | | | | | | |
| 10: | 10.3 | ↓ | | | | | | | | | | | | | | | | | | | | | | | | | | | | | | | | | |
| Serie | 95.0 | | | | | | | | | | | | | | | | | | | | | | | | | | | | | | | | | | |
| Total | 95.0 | | | | | | | | | | | | | | | | | | | | | | | | | | | | | | | | | | |

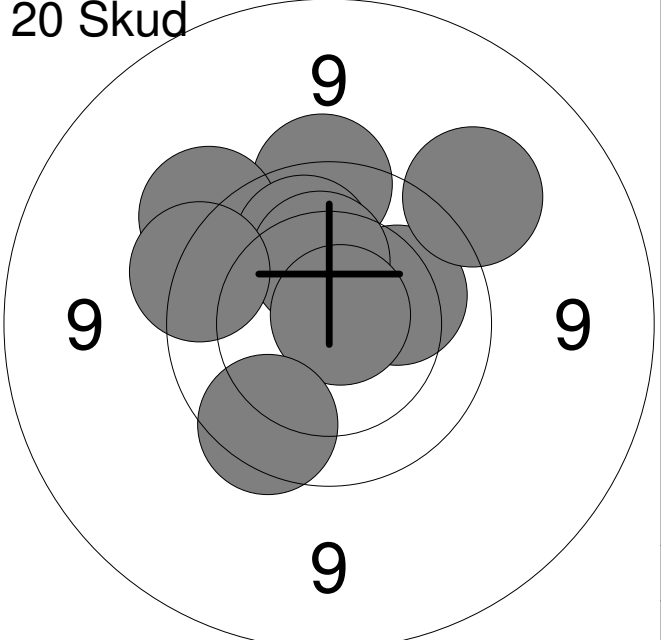
| | | | | | | | | | | | | | | | | | | | | | | | | | | | | | | | | | | | |
|--|---|-----|-----|---|-----|-----|---|-----|-----|---|-----|------|---|-----|-----|---|-----|------|---|-----|------|---|-----|-----|---|-----|-------|---|-----|-----|---|-------|------|-------|-------|
| <p>20 Skud</p>  | <table style="width:100%; border-collapse: collapse;"> <tr><td style="width:10%;">11:</td><td style="width:15%;">9.9</td><td style="width:10%; text-align: center;">↑</td></tr> <tr><td>12:</td><td>9.7</td><td style="text-align: center;">↑</td></tr> <tr><td>13:</td><td>9.5</td><td style="text-align: center;">↖</td></tr> <tr><td>14:</td><td>10.2</td><td style="text-align: center;">→</td></tr> <tr><td>15:</td><td>9.3</td><td style="text-align: center;">↗</td></tr> <tr><td>16:</td><td>10.1</td><td style="text-align: center;">↑</td></tr> <tr><td>17:</td><td>10.3</td><td style="text-align: center;">↑</td></tr> <tr><td>18:</td><td>9.7</td><td style="text-align: center;">↖</td></tr> <tr><td>19:</td><td>*10.8</td><td style="text-align: center;">↗</td></tr> <tr><td>20:</td><td>9.8</td><td style="text-align: center;">↙</td></tr> </table> <table border="1" style="width:100%; border-collapse: collapse; margin-top: 5px;"> <tr> <td style="width:80%;">Serie</td> <td style="text-align: right;">94.0</td> </tr> <tr> <td>Total</td> <td style="text-align: right;">189.0</td> </tr> </table> | 11: | 9.9 | ↑ | 12: | 9.7 | ↑ | 13: | 9.5 | ↖ | 14: | 10.2 | → | 15: | 9.3 | ↗ | 16: | 10.1 | ↑ | 17: | 10.3 | ↑ | 18: | 9.7 | ↖ | 19: | *10.8 | ↗ | 20: | 9.8 | ↙ | Serie | 94.0 | Total | 189.0 |
| 11: | 9.9 | ↑ | | | | | | | | | | | | | | | | | | | | | | | | | | | | | | | | | |
| 12: | 9.7 | ↑ | | | | | | | | | | | | | | | | | | | | | | | | | | | | | | | | | |
| 13: | 9.5 | ↖ | | | | | | | | | | | | | | | | | | | | | | | | | | | | | | | | | |
| 14: | 10.2 | → | | | | | | | | | | | | | | | | | | | | | | | | | | | | | | | | | |
| 15: | 9.3 | ↗ | | | | | | | | | | | | | | | | | | | | | | | | | | | | | | | | | |
| 16: | 10.1 | ↑ | | | | | | | | | | | | | | | | | | | | | | | | | | | | | | | | | |
| 17: | 10.3 | ↑ | | | | | | | | | | | | | | | | | | | | | | | | | | | | | | | | | |
| 18: | 9.7 | ↖ | | | | | | | | | | | | | | | | | | | | | | | | | | | | | | | | | |
| 19: | *10.8 | ↗ | | | | | | | | | | | | | | | | | | | | | | | | | | | | | | | | | |
| 20: | 9.8 | ↙ | | | | | | | | | | | | | | | | | | | | | | | | | | | | | | | | | |
| Serie | 94.0 | | | | | | | | | | | | | | | | | | | | | | | | | | | | | | | | | | |
| Total | 189.0 | | | | | | | | | | | | | | | | | | | | | | | | | | | | | | | | | | |

| | | | | | | | | | | | | | | | | | | | | | | | | | | | | | | | |
|---|---|-------|-----|------|-------|-----|-----|----|------|---|----|------|---|----|-------|---|----|------|---|----|------|---|----|-----|---|----|-------|---|-----|-------|---|
| <p>Prøve</p> | <table style="width:100%; border-collapse: collapse;"> <tr><td style="width:10%;">1:</td><td style="width:15%;">9.9</td><td style="width:10%; text-align: center;">↓</td></tr> <tr><td>2:</td><td>9.8</td><td style="text-align: center;">↙</td></tr> <tr><td>3:</td><td>10.1</td><td style="text-align: center;">↙</td></tr> <tr><td>4:</td><td>10.3</td><td style="text-align: center;">↓</td></tr> <tr><td>5:</td><td>*10.7</td><td style="text-align: center;">↓</td></tr> <tr><td>6:</td><td>10.0</td><td style="text-align: center;">↗</td></tr> <tr><td>7:</td><td>10.4</td><td style="text-align: center;">↘</td></tr> <tr><td>8:</td><td>9.5</td><td style="text-align: center;">↙</td></tr> <tr><td>9:</td><td>*10.6</td><td style="text-align: center;">↓</td></tr> <tr><td>10:</td><td>*10.7</td><td style="text-align: center;">↙</td></tr> </table> | 1: | 9.9 | ↓ | 2: | 9.8 | ↙ | 3: | 10.1 | ↙ | 4: | 10.3 | ↓ | 5: | *10.7 | ↓ | 6: | 10.0 | ↗ | 7: | 10.4 | ↘ | 8: | 9.5 | ↙ | 9: | *10.6 | ↓ | 10: | *10.7 | ↙ |
| 1: | 9.9 | ↓ | | | | | | | | | | | | | | | | | | | | | | | | | | | | | |
| 2: | 9.8 | ↙ | | | | | | | | | | | | | | | | | | | | | | | | | | | | | |
| 3: | 10.1 | ↙ | | | | | | | | | | | | | | | | | | | | | | | | | | | | | |
| 4: | 10.3 | ↓ | | | | | | | | | | | | | | | | | | | | | | | | | | | | | |
| 5: | *10.7 | ↓ | | | | | | | | | | | | | | | | | | | | | | | | | | | | | |
| 6: | 10.0 | ↗ | | | | | | | | | | | | | | | | | | | | | | | | | | | | | |
| 7: | 10.4 | ↘ | | | | | | | | | | | | | | | | | | | | | | | | | | | | | |
| 8: | 9.5 | ↙ | | | | | | | | | | | | | | | | | | | | | | | | | | | | | |
| 9: | *10.6 | ↓ | | | | | | | | | | | | | | | | | | | | | | | | | | | | | |
| 10: | *10.7 | ↙ | | | | | | | | | | | | | | | | | | | | | | | | | | | | | |
| <table style="width:100%; border-collapse: collapse;"> <tr> <td style="width:10%;">Serie</td> <td style="width:15%;"></td> <td style="width:10%; text-align: right;">97.0</td> </tr> <tr> <td>Total</td> <td></td> <td style="text-align: right;">0.0</td> </tr> </table> | | Serie | | 97.0 | Total | | 0.0 | | | | | | | | | | | | | | | | | | | | | | | | |
| Serie | | 97.0 | | | | | | | | | | | | | | | | | | | | | | | | | | | | | |
| Total | | 0.0 | | | | | | | | | | | | | | | | | | | | | | | | | | | | | |

| | | | | | | | | | | | | | | | | | | | | | | | | | | | | | | | |
|--|--|-------|------|------|-------|-------|------|----|-----|---|----|------|---|----|------|---|----|-------|---|----|-------|---|----|-------|---|----|------|---|-----|------|---|
| <p>20 Skud</p> | <table style="width:100%; border-collapse: collapse;"> <tr><td style="width:10%;">1:</td><td style="width:15%;">10.3</td><td style="width:10%; text-align: center;">↓</td></tr> <tr><td>2:</td><td>*10.8</td><td style="text-align: center;">↑</td></tr> <tr><td>3:</td><td>9.8</td><td style="text-align: center;">↙</td></tr> <tr><td>4:</td><td>10.4</td><td style="text-align: center;">↓</td></tr> <tr><td>5:</td><td>10.1</td><td style="text-align: center;">↓</td></tr> <tr><td>6:</td><td>*10.7</td><td style="text-align: center;">↙</td></tr> <tr><td>7:</td><td>*10.6</td><td style="text-align: center;">↙</td></tr> <tr><td>8:</td><td>*10.9</td><td style="text-align: center;">↙</td></tr> <tr><td>9:</td><td>10.4</td><td style="text-align: center;">↓</td></tr> <tr><td>10:</td><td>10.4</td><td style="text-align: center;">↓</td></tr> </table> | 1: | 10.3 | ↓ | 2: | *10.8 | ↑ | 3: | 9.8 | ↙ | 4: | 10.4 | ↓ | 5: | 10.1 | ↓ | 6: | *10.7 | ↙ | 7: | *10.6 | ↙ | 8: | *10.9 | ↙ | 9: | 10.4 | ↓ | 10: | 10.4 | ↓ |
| 1: | 10.3 | ↓ | | | | | | | | | | | | | | | | | | | | | | | | | | | | | |
| 2: | *10.8 | ↑ | | | | | | | | | | | | | | | | | | | | | | | | | | | | | |
| 3: | 9.8 | ↙ | | | | | | | | | | | | | | | | | | | | | | | | | | | | | |
| 4: | 10.4 | ↓ | | | | | | | | | | | | | | | | | | | | | | | | | | | | | |
| 5: | 10.1 | ↓ | | | | | | | | | | | | | | | | | | | | | | | | | | | | | |
| 6: | *10.7 | ↙ | | | | | | | | | | | | | | | | | | | | | | | | | | | | | |
| 7: | *10.6 | ↙ | | | | | | | | | | | | | | | | | | | | | | | | | | | | | |
| 8: | *10.9 | ↙ | | | | | | | | | | | | | | | | | | | | | | | | | | | | | |
| 9: | 10.4 | ↓ | | | | | | | | | | | | | | | | | | | | | | | | | | | | | |
| 10: | 10.4 | ↓ | | | | | | | | | | | | | | | | | | | | | | | | | | | | | |
| <table style="width:100%; border-collapse: collapse;"> <tr> <td style="width:10%;">Serie</td> <td style="width:15%;"></td> <td style="width:10%; text-align: right;">99.0</td> </tr> <tr> <td>Total</td> <td></td> <td style="text-align: right;">99.0</td> </tr> </table> | | Serie | | 99.0 | Total | | 99.0 | | | | | | | | | | | | | | | | | | | | | | | | |
| Serie | | 99.0 | | | | | | | | | | | | | | | | | | | | | | | | | | | | | |
| Total | | 99.0 | | | | | | | | | | | | | | | | | | | | | | | | | | | | | |

| | | | | | | | | | | | | | | | | | | | | | | | | | | | | | | | |
|--|---|-------|------|-------|-------|------|-------|-----|------|---|-----|------|---|-----|-------|---|-----|-------|---|-----|-------|---|-----|------|---|-----|-------|---|-----|-------|---|
| <p>20 Skud</p> | <table style="width:100%; border-collapse: collapse;"> <tr><td style="width:10%;">11:</td><td style="width:15%;">10.3</td><td style="width:10%; text-align: center;">↓</td></tr> <tr><td>12:</td><td>10.4</td><td style="text-align: center;">↘</td></tr> <tr><td>13:</td><td>10.3</td><td style="text-align: center;">↙</td></tr> <tr><td>14:</td><td>10.2</td><td style="text-align: center;">↘</td></tr> <tr><td>15:</td><td>*10.8</td><td style="text-align: center;">↙</td></tr> <tr><td>16:</td><td>*10.6</td><td style="text-align: center;">↙</td></tr> <tr><td>17:</td><td>*10.6</td><td style="text-align: center;">↗</td></tr> <tr><td>18:</td><td>10.1</td><td style="text-align: center;">↙</td></tr> <tr><td>19:</td><td>*10.5</td><td style="text-align: center;">↙</td></tr> <tr><td>20:</td><td>*10.6</td><td style="text-align: center;">↓</td></tr> </table> | 11: | 10.3 | ↓ | 12: | 10.4 | ↘ | 13: | 10.3 | ↙ | 14: | 10.2 | ↘ | 15: | *10.8 | ↙ | 16: | *10.6 | ↙ | 17: | *10.6 | ↗ | 18: | 10.1 | ↙ | 19: | *10.5 | ↙ | 20: | *10.6 | ↓ |
| 11: | 10.3 | ↓ | | | | | | | | | | | | | | | | | | | | | | | | | | | | | |
| 12: | 10.4 | ↘ | | | | | | | | | | | | | | | | | | | | | | | | | | | | | |
| 13: | 10.3 | ↙ | | | | | | | | | | | | | | | | | | | | | | | | | | | | | |
| 14: | 10.2 | ↘ | | | | | | | | | | | | | | | | | | | | | | | | | | | | | |
| 15: | *10.8 | ↙ | | | | | | | | | | | | | | | | | | | | | | | | | | | | | |
| 16: | *10.6 | ↙ | | | | | | | | | | | | | | | | | | | | | | | | | | | | | |
| 17: | *10.6 | ↗ | | | | | | | | | | | | | | | | | | | | | | | | | | | | | |
| 18: | 10.1 | ↙ | | | | | | | | | | | | | | | | | | | | | | | | | | | | | |
| 19: | *10.5 | ↙ | | | | | | | | | | | | | | | | | | | | | | | | | | | | | |
| 20: | *10.6 | ↓ | | | | | | | | | | | | | | | | | | | | | | | | | | | | | |
| <table style="width:100%; border-collapse: collapse;"> <tr> <td style="width:10%;">Serie</td> <td style="width:15%;"></td> <td style="width:10%; text-align: right;">100.0</td> </tr> <tr> <td>Total</td> <td></td> <td style="text-align: right;">199.0</td> </tr> </table> | | Serie | | 100.0 | Total | | 199.0 | | | | | | | | | | | | | | | | | | | | | | | | |
| Serie | | 100.0 | | | | | | | | | | | | | | | | | | | | | | | | | | | | | |
| Total | | 199.0 | | | | | | | | | | | | | | | | | | | | | | | | | | | | | |

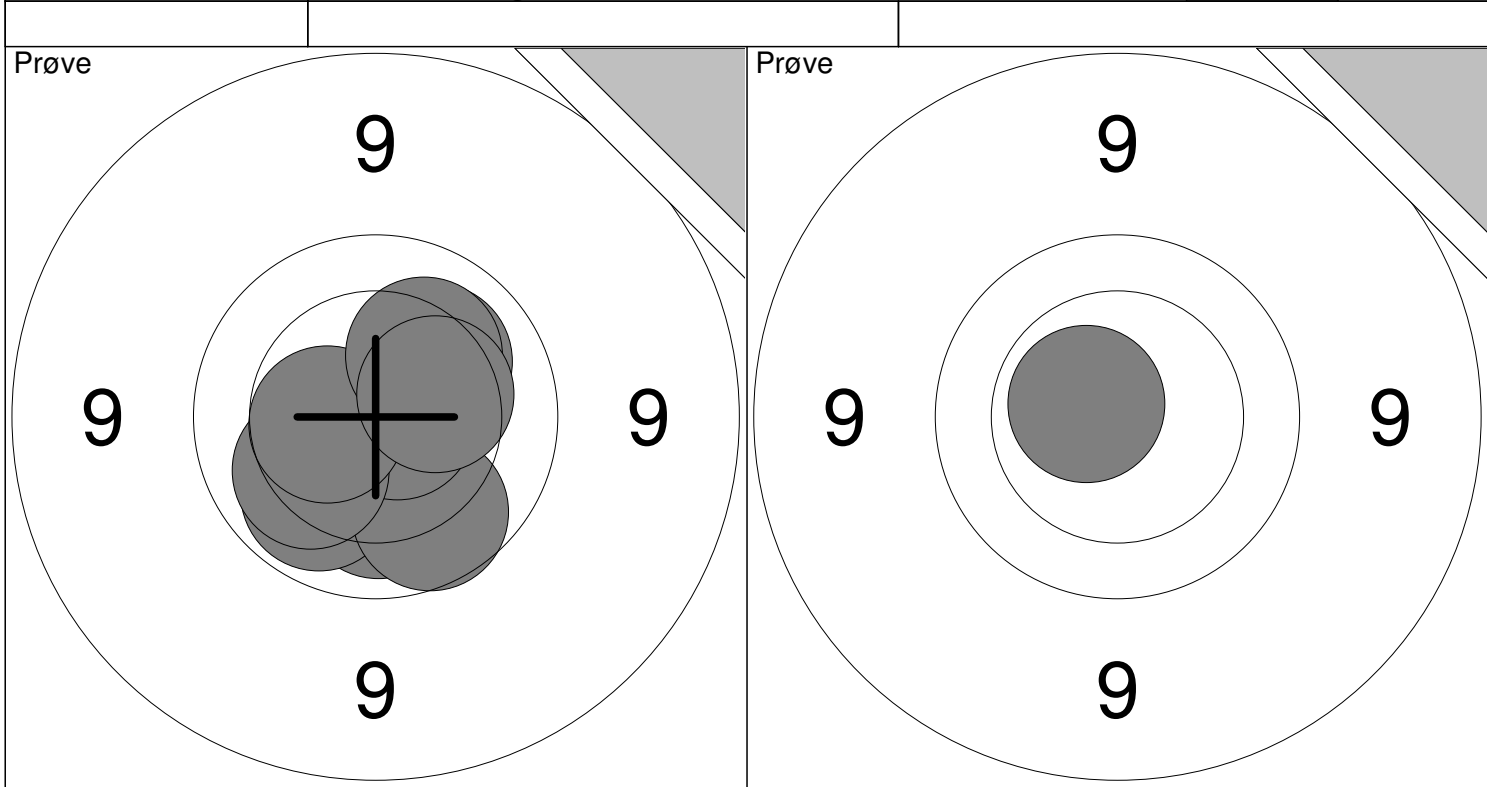

| | | | | | | |
|------------|------------|-------|------|-------------|-------|------|
| 1: 10.1 ↓ | 6: 10.1 ↙ | Serie | 99.0 | | Serie | 10.0 |
| 2: 10.0 ↙ | 7: 10.2 ↗ | | | | | |
| 3: *10.7 ↓ | 8: 10.5 ← | Total | 0.0 | | Total | 0.0 |
| 4: 9.9 ↓ | 9: 10.2 ↗ | | | | | |
| 5: *10.7 → | 10: 10.3 → | | | 11: *10.6 ↖ | | |

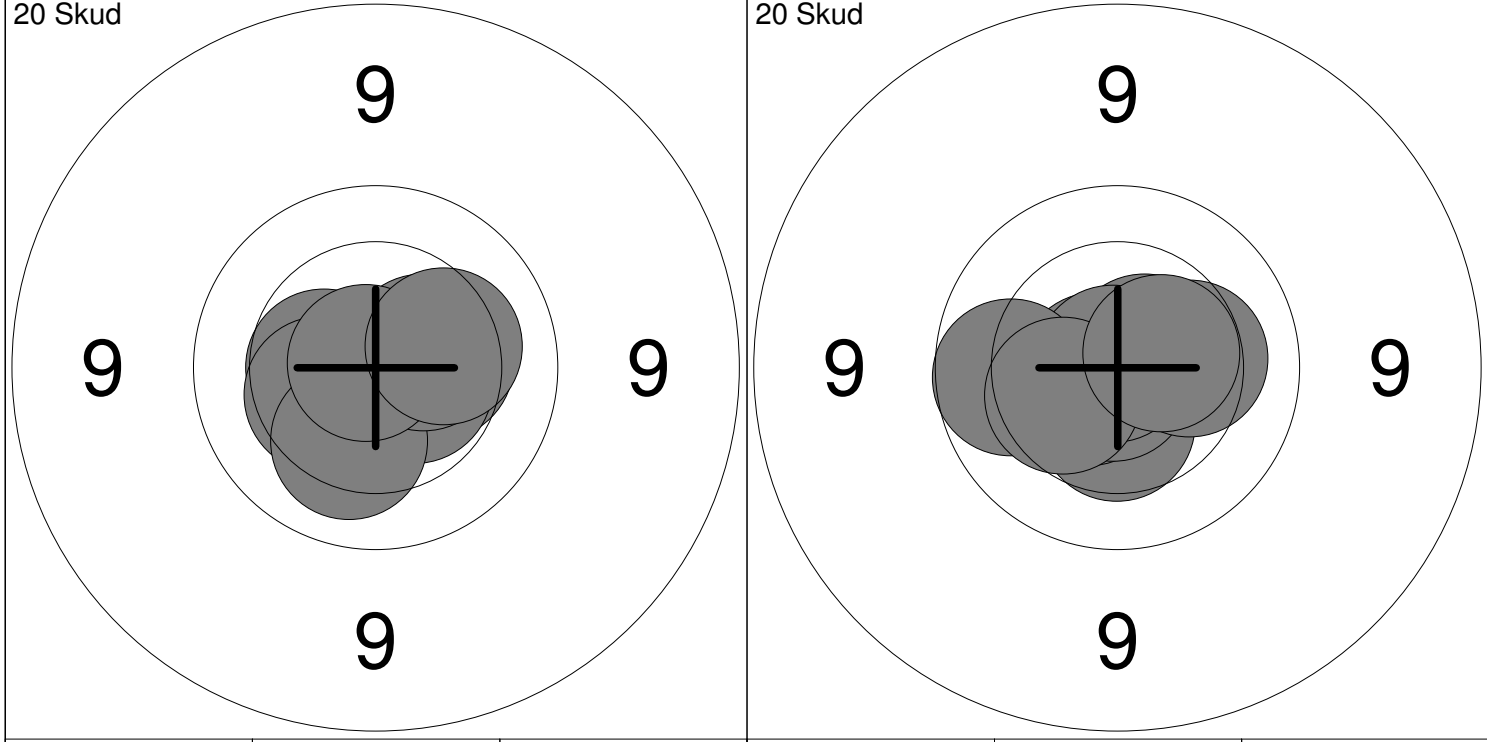

| | | | | | | | |
|------------|------------|-------|-------|-------------|-------------|-------|-------|
| 1: *10.7 ↖ | 6: *10.5 → | Serie | 100.0 | 11: 10.4 ↓ | 16: *10.9 ↖ | Serie | 99.0 |
| 2: 10.5 ← | 7: 10.2 ↓ | | | 12: *10.6 ↙ | 17: 9.9 ← | | |
| 3: 10.4 → | 8: 10.5 → | Total | 100.0 | 13: *10.8 ← | 18: 10.4 ← | Total | 199.0 |
| 4: *10.5 ↓ | 9: *10.8 ↖ | | | 14: *10.8 ↓ | 19: 10.3 → | | |
| 5: 10.4 ↖ | 10: 10.3 → | | | 15: *10.6 ↗ | 20: *10.5 → | | |

| | | | | | | | | | | | | | | | | | | | | | | | | | | | | | | | | | | | |
|---------------------|--|----|------|---|----|-----|---|----|-----|---|----|-----|---|----|-----|---|----|------|---|----|------|---|----|------|---|----|-------|---|-----|-------|---|-------|------|-------|-----|
| <p>Prøve</p> | <table style="width:100%; border-collapse: collapse;"> <tr><td style="text-align: right;">1:</td><td style="text-align: right;">10.5</td><td style="text-align: right;">↙</td></tr> <tr><td style="text-align: right;">2:</td><td style="text-align: right;">9.0</td><td style="text-align: right;">↓</td></tr> <tr><td style="text-align: right;">3:</td><td style="text-align: right;">9.9</td><td style="text-align: right;">↓</td></tr> <tr><td style="text-align: right;">4:</td><td style="text-align: right;">9.7</td><td style="text-align: right;">↓</td></tr> <tr><td style="text-align: right;">5:</td><td style="text-align: right;">9.8</td><td style="text-align: right;">↙</td></tr> <tr><td style="text-align: right;">6:</td><td style="text-align: right;">10.2</td><td style="text-align: right;">↓</td></tr> <tr><td style="text-align: right;">7:</td><td style="text-align: right;">10.5</td><td style="text-align: right;">↓</td></tr> <tr><td style="text-align: right;">8:</td><td style="text-align: right;">10.5</td><td style="text-align: right;">↗</td></tr> <tr><td style="text-align: right;">9:</td><td style="text-align: right;">*10.7</td><td style="text-align: right;">↓</td></tr> <tr><td style="text-align: right;">10:</td><td style="text-align: right;">*10.9</td><td style="text-align: right;">→</td></tr> </table> <table border="1" style="width:100%; border-collapse: collapse; margin-top: 5px;"> <tr> <td style="width:80%;">Serie</td> <td style="text-align: right;">96.0</td> </tr> <tr> <td>Total</td> <td style="text-align: right;">0.0</td> </tr> </table> | 1: | 10.5 | ↙ | 2: | 9.0 | ↓ | 3: | 9.9 | ↓ | 4: | 9.7 | ↓ | 5: | 9.8 | ↙ | 6: | 10.2 | ↓ | 7: | 10.5 | ↓ | 8: | 10.5 | ↗ | 9: | *10.7 | ↓ | 10: | *10.9 | → | Serie | 96.0 | Total | 0.0 |
| 1: | 10.5 | ↙ | | | | | | | | | | | | | | | | | | | | | | | | | | | | | | | | | |
| 2: | 9.0 | ↓ | | | | | | | | | | | | | | | | | | | | | | | | | | | | | | | | | |
| 3: | 9.9 | ↓ | | | | | | | | | | | | | | | | | | | | | | | | | | | | | | | | | |
| 4: | 9.7 | ↓ | | | | | | | | | | | | | | | | | | | | | | | | | | | | | | | | | |
| 5: | 9.8 | ↙ | | | | | | | | | | | | | | | | | | | | | | | | | | | | | | | | | |
| 6: | 10.2 | ↓ | | | | | | | | | | | | | | | | | | | | | | | | | | | | | | | | | |
| 7: | 10.5 | ↓ | | | | | | | | | | | | | | | | | | | | | | | | | | | | | | | | | |
| 8: | 10.5 | ↗ | | | | | | | | | | | | | | | | | | | | | | | | | | | | | | | | | |
| 9: | *10.7 | ↓ | | | | | | | | | | | | | | | | | | | | | | | | | | | | | | | | | |
| 10: | *10.9 | → | | | | | | | | | | | | | | | | | | | | | | | | | | | | | | | | | |
| Serie | 96.0 | | | | | | | | | | | | | | | | | | | | | | | | | | | | | | | | | | |
| Total | 0.0 | | | | | | | | | | | | | | | | | | | | | | | | | | | | | | | | | | |

| | | | | | | | | | | | | | | | | | | | | | | | | | | | | | | | | | | | |
|-----------------------|---|----|-------|---|----|-------|---|----|-------|---|----|------|---|----|-------|---|----|------|---|----|-------|---|----|------|---|----|-------|---|-----|------|---|-------|-------|-------|-------|
| <p>20 Skud</p> | <table style="width:100%; border-collapse: collapse;"> <tr><td style="text-align: right;">1:</td><td style="text-align: right;">*10.6</td><td style="text-align: right;">↓</td></tr> <tr><td style="text-align: right;">2:</td><td style="text-align: right;">*10.7</td><td style="text-align: right;">↙</td></tr> <tr><td style="text-align: right;">3:</td><td style="text-align: right;">*10.7</td><td style="text-align: right;">↗</td></tr> <tr><td style="text-align: right;">4:</td><td style="text-align: right;">10.2</td><td style="text-align: right;">↓</td></tr> <tr><td style="text-align: right;">5:</td><td style="text-align: right;">*10.6</td><td style="text-align: right;">↗</td></tr> <tr><td style="text-align: right;">6:</td><td style="text-align: right;">10.3</td><td style="text-align: right;">↓</td></tr> <tr><td style="text-align: right;">7:</td><td style="text-align: right;">*10.7</td><td style="text-align: right;">→</td></tr> <tr><td style="text-align: right;">8:</td><td style="text-align: right;">10.3</td><td style="text-align: right;">↓</td></tr> <tr><td style="text-align: right;">9:</td><td style="text-align: right;">*10.6</td><td style="text-align: right;">↓</td></tr> <tr><td style="text-align: right;">10:</td><td style="text-align: right;">10.5</td><td style="text-align: right;">→</td></tr> </table> <table border="1" style="width:100%; border-collapse: collapse; margin-top: 5px;"> <tr> <td style="width:80%;">Serie</td> <td style="text-align: right;">100.0</td> </tr> <tr> <td>Total</td> <td style="text-align: right;">100.0</td> </tr> </table> | 1: | *10.6 | ↓ | 2: | *10.7 | ↙ | 3: | *10.7 | ↗ | 4: | 10.2 | ↓ | 5: | *10.6 | ↗ | 6: | 10.3 | ↓ | 7: | *10.7 | → | 8: | 10.3 | ↓ | 9: | *10.6 | ↓ | 10: | 10.5 | → | Serie | 100.0 | Total | 100.0 |
| 1: | *10.6 | ↓ | | | | | | | | | | | | | | | | | | | | | | | | | | | | | | | | | |
| 2: | *10.7 | ↙ | | | | | | | | | | | | | | | | | | | | | | | | | | | | | | | | | |
| 3: | *10.7 | ↗ | | | | | | | | | | | | | | | | | | | | | | | | | | | | | | | | | |
| 4: | 10.2 | ↓ | | | | | | | | | | | | | | | | | | | | | | | | | | | | | | | | | |
| 5: | *10.6 | ↗ | | | | | | | | | | | | | | | | | | | | | | | | | | | | | | | | | |
| 6: | 10.3 | ↓ | | | | | | | | | | | | | | | | | | | | | | | | | | | | | | | | | |
| 7: | *10.7 | → | | | | | | | | | | | | | | | | | | | | | | | | | | | | | | | | | |
| 8: | 10.3 | ↓ | | | | | | | | | | | | | | | | | | | | | | | | | | | | | | | | | |
| 9: | *10.6 | ↓ | | | | | | | | | | | | | | | | | | | | | | | | | | | | | | | | | |
| 10: | 10.5 | → | | | | | | | | | | | | | | | | | | | | | | | | | | | | | | | | | |
| Serie | 100.0 | | | | | | | | | | | | | | | | | | | | | | | | | | | | | | | | | | |
| Total | 100.0 | | | | | | | | | | | | | | | | | | | | | | | | | | | | | | | | | | |

| | | | | | | | | | | | | | | | | | | | | | | | | | | | | | | | | | | | |
|-----------------------|---|-----|-------|---|-----|-------|---|-----|-------|---|-----|------|---|-----|-------|---|-----|------|---|-----|-------|---|-----|-----|---|-----|------|---|-----|------|---|-------|------|-------|-------|
| <p>20 Skud</p> | <table style="width:100%; border-collapse: collapse;"> <tr><td style="text-align: right;">11:</td><td style="text-align: right;">*10.5</td><td style="text-align: right;">↘</td></tr> <tr><td style="text-align: right;">12:</td><td style="text-align: right;">*10.5</td><td style="text-align: right;">↗</td></tr> <tr><td style="text-align: right;">13:</td><td style="text-align: right;">*10.7</td><td style="text-align: right;">↙</td></tr> <tr><td style="text-align: right;">14:</td><td style="text-align: right;">10.1</td><td style="text-align: right;">↘</td></tr> <tr><td style="text-align: right;">15:</td><td style="text-align: right;">*10.7</td><td style="text-align: right;">↗</td></tr> <tr><td style="text-align: right;">16:</td><td style="text-align: right;">10.3</td><td style="text-align: right;">↘</td></tr> <tr><td style="text-align: right;">17:</td><td style="text-align: right;">*10.6</td><td style="text-align: right;">↘</td></tr> <tr><td style="text-align: right;">18:</td><td style="text-align: right;">9.9</td><td style="text-align: right;">↘</td></tr> <tr><td style="text-align: right;">19:</td><td style="text-align: right;">10.1</td><td style="text-align: right;">↘</td></tr> <tr><td style="text-align: right;">20:</td><td style="text-align: right;">10.2</td><td style="text-align: right;">↓</td></tr> </table> <table border="1" style="width:100%; border-collapse: collapse; margin-top: 5px;"> <tr> <td style="width:80%;">Serie</td> <td style="text-align: right;">99.0</td> </tr> <tr> <td>Total</td> <td style="text-align: right;">199.0</td> </tr> </table> | 11: | *10.5 | ↘ | 12: | *10.5 | ↗ | 13: | *10.7 | ↙ | 14: | 10.1 | ↘ | 15: | *10.7 | ↗ | 16: | 10.3 | ↘ | 17: | *10.6 | ↘ | 18: | 9.9 | ↘ | 19: | 10.1 | ↘ | 20: | 10.2 | ↓ | Serie | 99.0 | Total | 199.0 |
| 11: | *10.5 | ↘ | | | | | | | | | | | | | | | | | | | | | | | | | | | | | | | | | |
| 12: | *10.5 | ↗ | | | | | | | | | | | | | | | | | | | | | | | | | | | | | | | | | |
| 13: | *10.7 | ↙ | | | | | | | | | | | | | | | | | | | | | | | | | | | | | | | | | |
| 14: | 10.1 | ↘ | | | | | | | | | | | | | | | | | | | | | | | | | | | | | | | | | |
| 15: | *10.7 | ↗ | | | | | | | | | | | | | | | | | | | | | | | | | | | | | | | | | |
| 16: | 10.3 | ↘ | | | | | | | | | | | | | | | | | | | | | | | | | | | | | | | | | |
| 17: | *10.6 | ↘ | | | | | | | | | | | | | | | | | | | | | | | | | | | | | | | | | |
| 18: | 9.9 | ↘ | | | | | | | | | | | | | | | | | | | | | | | | | | | | | | | | | |
| 19: | 10.1 | ↘ | | | | | | | | | | | | | | | | | | | | | | | | | | | | | | | | | |
| 20: | 10.2 | ↓ | | | | | | | | | | | | | | | | | | | | | | | | | | | | | | | | | |
| Serie | 99.0 | | | | | | | | | | | | | | | | | | | | | | | | | | | | | | | | | | |
| Total | 199.0 | | | | | | | | | | | | | | | | | | | | | | | | | | | | | | | | | | |

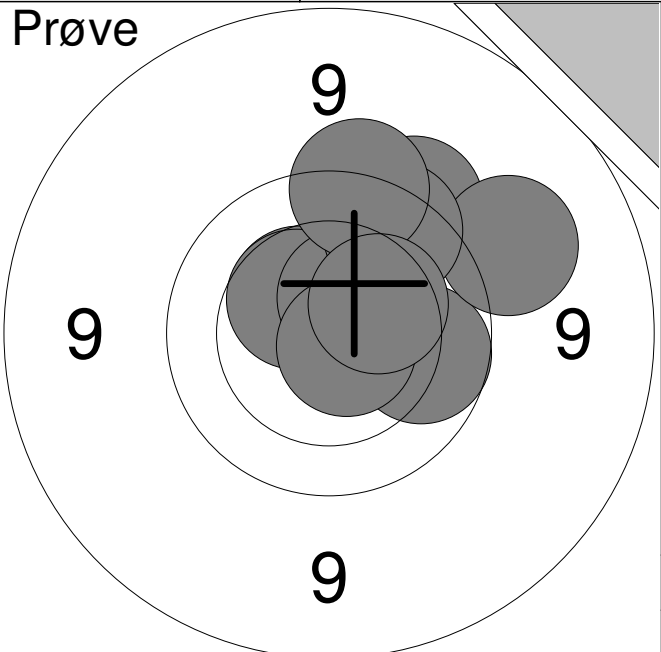
| | | | | | | | | | | | | | | | | | | | | | | | | | | | | | | | | | | | | | |
|--|--|------|-----|---|----|------|---|----|------|---|----|-----|---|----|-----|---|----|-------|---|----|-------|---|----|-----|---|----|-----|---|-----|------|---|-------|--|------|-------|--|-----|
| <p>Prøve</p>  | <table style="width:100%; border-collapse: collapse;"> <tr><td style="text-align: right;">1:</td><td style="text-align: right;">9.9</td><td style="text-align: right;">→</td></tr> <tr><td style="text-align: right;">2:</td><td style="text-align: right;">10.4</td><td style="text-align: right;">↗</td></tr> <tr><td style="text-align: right;">3:</td><td style="text-align: right;">10.4</td><td style="text-align: right;">↗</td></tr> <tr><td style="text-align: right;">4:</td><td style="text-align: right;">9.6</td><td style="text-align: right;">↗</td></tr> <tr><td style="text-align: right;">5:</td><td style="text-align: right;">9.3</td><td style="text-align: right;">↗</td></tr> <tr><td style="text-align: right;">6:</td><td style="text-align: right;">*10.5</td><td style="text-align: right;">↗</td></tr> <tr><td style="text-align: right;">7:</td><td style="text-align: right;">*10.7</td><td style="text-align: right;">↘</td></tr> <tr><td style="text-align: right;">8:</td><td style="text-align: right;">9.8</td><td style="text-align: right;">↗</td></tr> <tr><td style="text-align: right;">9:</td><td style="text-align: right;">9.6</td><td style="text-align: right;">↑</td></tr> <tr><td style="text-align: right;">10:</td><td style="text-align: right;">10.3</td><td style="text-align: right;">↗</td></tr> <tr><td colspan="2">Serie</td><td style="text-align: right;">95.0</td></tr> <tr><td colspan="2">Total</td><td style="text-align: right;">0.0</td></tr> </table> | 1: | 9.9 | → | 2: | 10.4 | ↗ | 3: | 10.4 | ↗ | 4: | 9.6 | ↗ | 5: | 9.3 | ↗ | 6: | *10.5 | ↗ | 7: | *10.7 | ↘ | 8: | 9.8 | ↗ | 9: | 9.6 | ↑ | 10: | 10.3 | ↗ | Serie | | 95.0 | Total | | 0.0 |
| 1: | 9.9 | → | | | | | | | | | | | | | | | | | | | | | | | | | | | | | | | | | | | |
| 2: | 10.4 | ↗ | | | | | | | | | | | | | | | | | | | | | | | | | | | | | | | | | | | |
| 3: | 10.4 | ↗ | | | | | | | | | | | | | | | | | | | | | | | | | | | | | | | | | | | |
| 4: | 9.6 | ↗ | | | | | | | | | | | | | | | | | | | | | | | | | | | | | | | | | | | |
| 5: | 9.3 | ↗ | | | | | | | | | | | | | | | | | | | | | | | | | | | | | | | | | | | |
| 6: | *10.5 | ↗ | | | | | | | | | | | | | | | | | | | | | | | | | | | | | | | | | | | |
| 7: | *10.7 | ↘ | | | | | | | | | | | | | | | | | | | | | | | | | | | | | | | | | | | |
| 8: | 9.8 | ↗ | | | | | | | | | | | | | | | | | | | | | | | | | | | | | | | | | | | |
| 9: | 9.6 | ↑ | | | | | | | | | | | | | | | | | | | | | | | | | | | | | | | | | | | |
| 10: | 10.3 | ↗ | | | | | | | | | | | | | | | | | | | | | | | | | | | | | | | | | | | |
| Serie | | 95.0 | | | | | | | | | | | | | | | | | | | | | | | | | | | | | | | | | | | |
| Total | | 0.0 | | | | | | | | | | | | | | | | | | | | | | | | | | | | | | | | | | | |

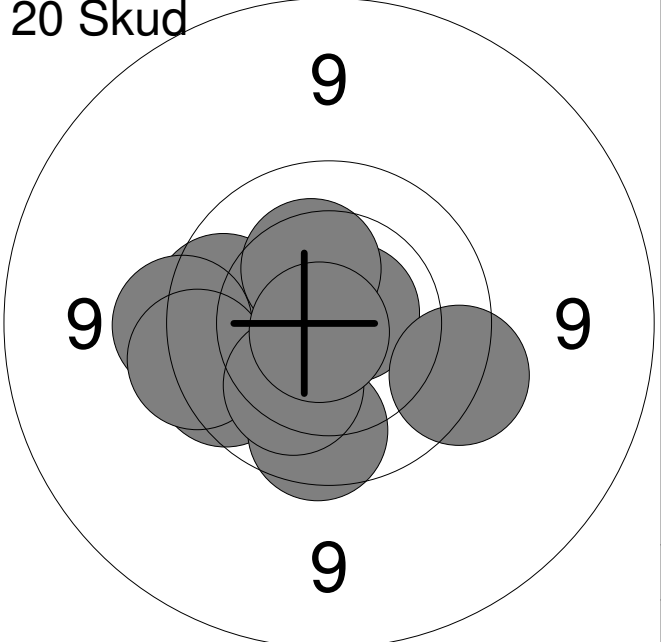
| | | | | | | | | | | | | | | | | | | | | | | | | | | | | | | | | | | | | | |
|---|--|------|-----|---|----|-------|---|----|-----|---|----|-----|---|----|-----|---|----|-----|---|----|------|---|----|-----|---|----|------|---|-----|-------|---|-------|--|------|-------|--|------|
| <p>20 Skud</p>  | <table style="width:100%; border-collapse: collapse;"> <tr><td style="text-align: right;">1:</td><td style="text-align: right;">9.8</td><td style="text-align: right;">↖</td></tr> <tr><td style="text-align: right;">2:</td><td style="text-align: right;">*10.7</td><td style="text-align: right;">↗</td></tr> <tr><td style="text-align: right;">3:</td><td style="text-align: right;">9.9</td><td style="text-align: right;">↖</td></tr> <tr><td style="text-align: right;">4:</td><td style="text-align: right;">9.6</td><td style="text-align: right;">←</td></tr> <tr><td style="text-align: right;">5:</td><td style="text-align: right;">9.9</td><td style="text-align: right;">↓</td></tr> <tr><td style="text-align: right;">6:</td><td style="text-align: right;">9.7</td><td style="text-align: right;">↖</td></tr> <tr><td style="text-align: right;">7:</td><td style="text-align: right;">10.3</td><td style="text-align: right;">↗</td></tr> <tr><td style="text-align: right;">8:</td><td style="text-align: right;">9.7</td><td style="text-align: right;">↗</td></tr> <tr><td style="text-align: right;">9:</td><td style="text-align: right;">10.2</td><td style="text-align: right;">↘</td></tr> <tr><td style="text-align: right;">10:</td><td style="text-align: right;">*10.8</td><td style="text-align: right;">↖</td></tr> <tr><td colspan="2">Serie</td><td style="text-align: right;">94.0</td></tr> <tr><td colspan="2">Total</td><td style="text-align: right;">94.0</td></tr> </table> | 1: | 9.8 | ↖ | 2: | *10.7 | ↗ | 3: | 9.9 | ↖ | 4: | 9.6 | ← | 5: | 9.9 | ↓ | 6: | 9.7 | ↖ | 7: | 10.3 | ↗ | 8: | 9.7 | ↗ | 9: | 10.2 | ↘ | 10: | *10.8 | ↖ | Serie | | 94.0 | Total | | 94.0 |
| 1: | 9.8 | ↖ | | | | | | | | | | | | | | | | | | | | | | | | | | | | | | | | | | | |
| 2: | *10.7 | ↗ | | | | | | | | | | | | | | | | | | | | | | | | | | | | | | | | | | | |
| 3: | 9.9 | ↖ | | | | | | | | | | | | | | | | | | | | | | | | | | | | | | | | | | | |
| 4: | 9.6 | ← | | | | | | | | | | | | | | | | | | | | | | | | | | | | | | | | | | | |
| 5: | 9.9 | ↓ | | | | | | | | | | | | | | | | | | | | | | | | | | | | | | | | | | | |
| 6: | 9.7 | ↖ | | | | | | | | | | | | | | | | | | | | | | | | | | | | | | | | | | | |
| 7: | 10.3 | ↗ | | | | | | | | | | | | | | | | | | | | | | | | | | | | | | | | | | | |
| 8: | 9.7 | ↗ | | | | | | | | | | | | | | | | | | | | | | | | | | | | | | | | | | | |
| 9: | 10.2 | ↘ | | | | | | | | | | | | | | | | | | | | | | | | | | | | | | | | | | | |
| 10: | *10.8 | ↖ | | | | | | | | | | | | | | | | | | | | | | | | | | | | | | | | | | | |
| Serie | | 94.0 | | | | | | | | | | | | | | | | | | | | | | | | | | | | | | | | | | | |
| Total | | 94.0 | | | | | | | | | | | | | | | | | | | | | | | | | | | | | | | | | | | |

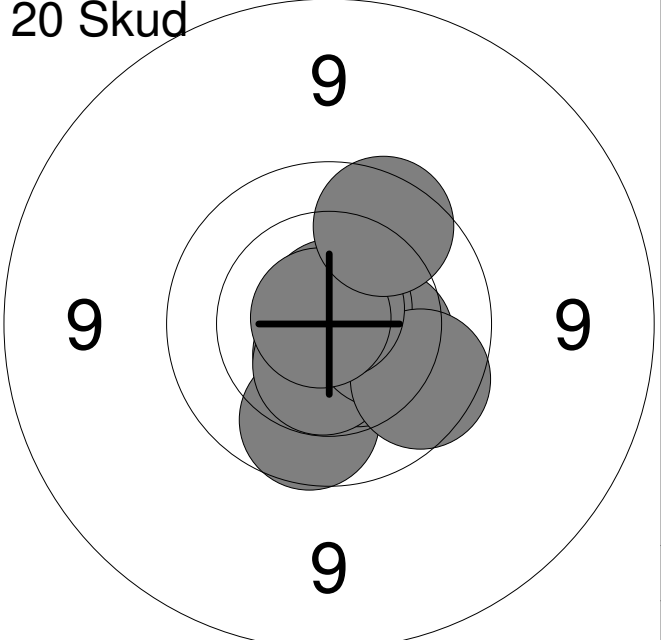
| | | | | | | | | | | | | | | | | | | | | | | | | | | | | | | | | | | | | | |
|--|--|-------|-------|---|-----|-----|---|-----|------|---|-----|-------|---|-----|------|---|-----|-------|---|-----|-----|---|-----|-------|---|-----|-------|---|-----|-----|---|-------|--|------|-------|--|-------|
| <p>20 Skud</p>  | <table style="width:100%; border-collapse: collapse;"> <tr><td style="text-align: right;">11:</td><td style="text-align: right;">*10.6</td><td style="text-align: right;">↓</td></tr> <tr><td style="text-align: right;">12:</td><td style="text-align: right;">9.9</td><td style="text-align: right;">↓</td></tr> <tr><td style="text-align: right;">13:</td><td style="text-align: right;">10.5</td><td style="text-align: right;">↘</td></tr> <tr><td style="text-align: right;">14:</td><td style="text-align: right;">*10.5</td><td style="text-align: right;">↓</td></tr> <tr><td style="text-align: right;">15:</td><td style="text-align: right;">10.3</td><td style="text-align: right;">↗</td></tr> <tr><td style="text-align: right;">16:</td><td style="text-align: right;">*10.7</td><td style="text-align: right;">↗</td></tr> <tr><td style="text-align: right;">17:</td><td style="text-align: right;">9.9</td><td style="text-align: right;">↘</td></tr> <tr><td style="text-align: right;">18:</td><td style="text-align: right;">*10.8</td><td style="text-align: right;">↗</td></tr> <tr><td style="text-align: right;">19:</td><td style="text-align: right;">*10.8</td><td style="text-align: right;">↗</td></tr> <tr><td style="text-align: right;">20:</td><td style="text-align: right;">9.8</td><td style="text-align: right;">↗</td></tr> <tr><td colspan="2">Serie</td><td style="text-align: right;">97.0</td></tr> <tr><td colspan="2">Total</td><td style="text-align: right;">191.0</td></tr> </table> | 11: | *10.6 | ↓ | 12: | 9.9 | ↓ | 13: | 10.5 | ↘ | 14: | *10.5 | ↓ | 15: | 10.3 | ↗ | 16: | *10.7 | ↗ | 17: | 9.9 | ↘ | 18: | *10.8 | ↗ | 19: | *10.8 | ↗ | 20: | 9.8 | ↗ | Serie | | 97.0 | Total | | 191.0 |
| 11: | *10.6 | ↓ | | | | | | | | | | | | | | | | | | | | | | | | | | | | | | | | | | | |
| 12: | 9.9 | ↓ | | | | | | | | | | | | | | | | | | | | | | | | | | | | | | | | | | | |
| 13: | 10.5 | ↘ | | | | | | | | | | | | | | | | | | | | | | | | | | | | | | | | | | | |
| 14: | *10.5 | ↓ | | | | | | | | | | | | | | | | | | | | | | | | | | | | | | | | | | | |
| 15: | 10.3 | ↗ | | | | | | | | | | | | | | | | | | | | | | | | | | | | | | | | | | | |
| 16: | *10.7 | ↗ | | | | | | | | | | | | | | | | | | | | | | | | | | | | | | | | | | | |
| 17: | 9.9 | ↘ | | | | | | | | | | | | | | | | | | | | | | | | | | | | | | | | | | | |
| 18: | *10.8 | ↗ | | | | | | | | | | | | | | | | | | | | | | | | | | | | | | | | | | | |
| 19: | *10.8 | ↗ | | | | | | | | | | | | | | | | | | | | | | | | | | | | | | | | | | | |
| 20: | 9.8 | ↗ | | | | | | | | | | | | | | | | | | | | | | | | | | | | | | | | | | | |
| Serie | | 97.0 | | | | | | | | | | | | | | | | | | | | | | | | | | | | | | | | | | | |
| Total | | 191.0 | | | | | | | | | | | | | | | | | | | | | | | | | | | | | | | | | | | |

| | | | | | | | | | | | | | | | | | | | | | | |
|---------------------|--|----|-------|---|----|-----|---|----|-------|---|----|------|---|----|------|---|----|------|---|----|------|---|
| <p>Prøve</p> | <table style="width:100%; border-collapse: collapse;"> <tr><td style="width:10%;">1:</td><td style="width:80%;">*10.7</td><td style="width:10%; text-align: right;">↓</td></tr> <tr><td>2:</td><td>9.2</td><td style="text-align: right;">→</td></tr> <tr><td>3:</td><td>*10.7</td><td style="text-align: right;">↗</td></tr> <tr><td>4:</td><td>10.0</td><td style="text-align: right;">↖</td></tr> <tr><td>5:</td><td>10.5</td><td style="text-align: right;">↗</td></tr> <tr><td>6:</td><td>10.2</td><td style="text-align: right;">↑</td></tr> <tr><td>7:</td><td>10.5</td><td style="text-align: right;">↑</td></tr> </table> | 1: | *10.7 | ↓ | 2: | 9.2 | → | 3: | *10.7 | ↗ | 4: | 10.0 | ↖ | 5: | 10.5 | ↗ | 6: | 10.2 | ↑ | 7: | 10.5 | ↑ |
| 1: | *10.7 | ↓ | | | | | | | | | | | | | | | | | | | | |
| 2: | 9.2 | → | | | | | | | | | | | | | | | | | | | | |
| 3: | *10.7 | ↗ | | | | | | | | | | | | | | | | | | | | |
| 4: | 10.0 | ↖ | | | | | | | | | | | | | | | | | | | | |
| 5: | 10.5 | ↗ | | | | | | | | | | | | | | | | | | | | |
| 6: | 10.2 | ↑ | | | | | | | | | | | | | | | | | | | | |
| 7: | 10.5 | ↑ | | | | | | | | | | | | | | | | | | | | |

| | |
|-------|------|
| Serie | 69.0 |
| Total | 0.0 |

| | | | | | | | | | | | | | | | | | | | | | | | | | | | | | | | |
|-----------------------|---|----|------|---|----|------|---|----|-----|---|----|-------|---|----|------|---|----|------|---|----|------|---|----|------|---|----|-------|---|-----|-------|---|
| <p>20 Skud</p> | <table style="width:100%; border-collapse: collapse;"> <tr><td style="width:10%;">1:</td><td style="width:80%;">10.4</td><td style="width:10%; text-align: right;">↖</td></tr> <tr><td>2:</td><td>10.3</td><td style="text-align: right;">↓</td></tr> <tr><td>3:</td><td>9.6</td><td style="text-align: right;">↖</td></tr> <tr><td>4:</td><td>*10.6</td><td style="text-align: right;">↓</td></tr> <tr><td>5:</td><td>10.2</td><td style="text-align: right;">↑</td></tr> <tr><td>6:</td><td>10.0</td><td style="text-align: right;">↖</td></tr> <tr><td>7:</td><td>10.1</td><td style="text-align: right;">↖</td></tr> <tr><td>8:</td><td>10.2</td><td style="text-align: right;">↖</td></tr> <tr><td>9:</td><td>*10.7</td><td style="text-align: right;">↖</td></tr> <tr><td>10:</td><td>*10.6</td><td style="text-align: right;">↘</td></tr> </table> | 1: | 10.4 | ↖ | 2: | 10.3 | ↓ | 3: | 9.6 | ↖ | 4: | *10.6 | ↓ | 5: | 10.2 | ↑ | 6: | 10.0 | ↖ | 7: | 10.1 | ↖ | 8: | 10.2 | ↖ | 9: | *10.7 | ↖ | 10: | *10.6 | ↘ |
| 1: | 10.4 | ↖ | | | | | | | | | | | | | | | | | | | | | | | | | | | | | |
| 2: | 10.3 | ↓ | | | | | | | | | | | | | | | | | | | | | | | | | | | | | |
| 3: | 9.6 | ↖ | | | | | | | | | | | | | | | | | | | | | | | | | | | | | |
| 4: | *10.6 | ↓ | | | | | | | | | | | | | | | | | | | | | | | | | | | | | |
| 5: | 10.2 | ↑ | | | | | | | | | | | | | | | | | | | | | | | | | | | | | |
| 6: | 10.0 | ↖ | | | | | | | | | | | | | | | | | | | | | | | | | | | | | |
| 7: | 10.1 | ↖ | | | | | | | | | | | | | | | | | | | | | | | | | | | | | |
| 8: | 10.2 | ↖ | | | | | | | | | | | | | | | | | | | | | | | | | | | | | |
| 9: | *10.7 | ↖ | | | | | | | | | | | | | | | | | | | | | | | | | | | | | |
| 10: | *10.6 | ↘ | | | | | | | | | | | | | | | | | | | | | | | | | | | | | |

| | |
|-------|------|
| Serie | 99.0 |
| Total | 99.0 |

| | | | | | | | | | | | | | | | | | | | | | | | | | | | | | | | |
|-----------------------|---|-----|-----|---|-----|-----|---|-----|-------|---|-----|------|---|-----|-------|---|-----|------|---|-----|-----|---|-----|------|---|-----|------|---|-----|------|---|
| <p>20 Skud</p> | <table style="width:100%; border-collapse: collapse;"> <tr><td style="width:10%;">11:</td><td style="width:80%;">9.9</td><td style="width:10%; text-align: right;">↓</td></tr> <tr><td>12:</td><td>9.8</td><td style="text-align: right;">↘</td></tr> <tr><td>13:</td><td>*10.8</td><td style="text-align: right;">↖</td></tr> <tr><td>14:</td><td>10.6</td><td style="text-align: right;">↗</td></tr> <tr><td>15:</td><td>*10.7</td><td style="text-align: right;">→</td></tr> <tr><td>16:</td><td>10.2</td><td style="text-align: right;">↓</td></tr> <tr><td>17:</td><td>9.6</td><td style="text-align: right;">→</td></tr> <tr><td>18:</td><td>10.5</td><td style="text-align: right;">↖</td></tr> <tr><td>19:</td><td>10.1</td><td style="text-align: right;">↓</td></tr> <tr><td>20:</td><td>10.4</td><td style="text-align: right;">→</td></tr> </table> | 11: | 9.9 | ↓ | 12: | 9.8 | ↘ | 13: | *10.8 | ↖ | 14: | 10.6 | ↗ | 15: | *10.7 | → | 16: | 10.2 | ↓ | 17: | 9.6 | → | 18: | 10.5 | ↖ | 19: | 10.1 | ↓ | 20: | 10.4 | → |
| 11: | 9.9 | ↓ | | | | | | | | | | | | | | | | | | | | | | | | | | | | | |
| 12: | 9.8 | ↘ | | | | | | | | | | | | | | | | | | | | | | | | | | | | | |
| 13: | *10.8 | ↖ | | | | | | | | | | | | | | | | | | | | | | | | | | | | | |
| 14: | 10.6 | ↗ | | | | | | | | | | | | | | | | | | | | | | | | | | | | | |
| 15: | *10.7 | → | | | | | | | | | | | | | | | | | | | | | | | | | | | | | |
| 16: | 10.2 | ↓ | | | | | | | | | | | | | | | | | | | | | | | | | | | | | |
| 17: | 9.6 | → | | | | | | | | | | | | | | | | | | | | | | | | | | | | | |
| 18: | 10.5 | ↖ | | | | | | | | | | | | | | | | | | | | | | | | | | | | | |
| 19: | 10.1 | ↓ | | | | | | | | | | | | | | | | | | | | | | | | | | | | | |
| 20: | 10.4 | → | | | | | | | | | | | | | | | | | | | | | | | | | | | | | |

| | |
|-------|-------|
| Serie | 97.0 |
| Total | 196.0 |

| | | | | | | | | | | | | | | | | | | | | | | |
|--|---|-------|-------|-------|-----|-------|---|----|-----|---|----|------|---|----|------|---|----|------|---|----|-------|---|
| <p>Prøve</p> | <table style="width:100%; border-collapse: collapse;"> <tr><td style="width:10%;">1:</td><td style="width:15%;">*10.6</td><td style="width:10%; text-align: right;">↗</td></tr> <tr><td>2:</td><td>*10.7</td><td style="text-align: right;">↘</td></tr> <tr><td>3:</td><td>9.9</td><td style="text-align: right;">↘</td></tr> <tr><td>4:</td><td>10.1</td><td style="text-align: right;">↘</td></tr> <tr><td>5:</td><td>10.2</td><td style="text-align: right;">↗</td></tr> <tr><td>6:</td><td>10.2</td><td style="text-align: right;">↗</td></tr> <tr><td>7:</td><td>*10.8</td><td style="text-align: right;">↘</td></tr> </table> | 1: | *10.6 | ↗ | 2: | *10.7 | ↘ | 3: | 9.9 | ↘ | 4: | 10.1 | ↘ | 5: | 10.2 | ↗ | 6: | 10.2 | ↗ | 7: | *10.8 | ↘ |
| 1: | *10.6 | ↗ | | | | | | | | | | | | | | | | | | | | |
| 2: | *10.7 | ↘ | | | | | | | | | | | | | | | | | | | | |
| 3: | 9.9 | ↘ | | | | | | | | | | | | | | | | | | | | |
| 4: | 10.1 | ↘ | | | | | | | | | | | | | | | | | | | | |
| 5: | 10.2 | ↗ | | | | | | | | | | | | | | | | | | | | |
| 6: | 10.2 | ↗ | | | | | | | | | | | | | | | | | | | | |
| 7: | *10.8 | ↘ | | | | | | | | | | | | | | | | | | | | |
| <table style="width:100%; border-collapse: collapse;"> <tr> <td style="width:90%;">Serie</td> <td style="width:10%; text-align: right;">69.0</td> </tr> <tr> <td>Total</td> <td style="text-align: right;">0.0</td> </tr> </table> | | Serie | 69.0 | Total | 0.0 | | | | | | | | | | | | | | | | | |
| Serie | 69.0 | | | | | | | | | | | | | | | | | | | | | |
| Total | 0.0 | | | | | | | | | | | | | | | | | | | | | |

| | | | | | | | | | | | | | | | | | | | | | | | | | | | | | | | |
|---|---|-------|-------|-------|-------|------|---|----|------|---|----|------|---|----|-------|---|----|------|---|----|------|---|----|-------|---|----|-------|---|-----|-------|---|
| <p>20 Skud</p> | <table style="width:100%; border-collapse: collapse;"> <tr><td style="width:10%;">1:</td><td style="width:15%;">10.3</td><td style="width:10%; text-align: right;">↗</td></tr> <tr><td>2:</td><td>10.0</td><td style="text-align: right;">→</td></tr> <tr><td>3:</td><td>10.5</td><td style="text-align: right;">↗</td></tr> <tr><td>4:</td><td>10.2</td><td style="text-align: right;">↘</td></tr> <tr><td>5:</td><td>*10.6</td><td style="text-align: right;">↗</td></tr> <tr><td>6:</td><td>10.4</td><td style="text-align: right;">↘</td></tr> <tr><td>7:</td><td>10.1</td><td style="text-align: right;">↗</td></tr> <tr><td>8:</td><td>*10.6</td><td style="text-align: right;">↗</td></tr> <tr><td>9:</td><td>*10.6</td><td style="text-align: right;">↗</td></tr> <tr><td>10:</td><td>*10.7</td><td style="text-align: right;">↗</td></tr> </table> | 1: | 10.3 | ↗ | 2: | 10.0 | → | 3: | 10.5 | ↗ | 4: | 10.2 | ↘ | 5: | *10.6 | ↗ | 6: | 10.4 | ↘ | 7: | 10.1 | ↗ | 8: | *10.6 | ↗ | 9: | *10.6 | ↗ | 10: | *10.7 | ↗ |
| 1: | 10.3 | ↗ | | | | | | | | | | | | | | | | | | | | | | | | | | | | | |
| 2: | 10.0 | → | | | | | | | | | | | | | | | | | | | | | | | | | | | | | |
| 3: | 10.5 | ↗ | | | | | | | | | | | | | | | | | | | | | | | | | | | | | |
| 4: | 10.2 | ↘ | | | | | | | | | | | | | | | | | | | | | | | | | | | | | |
| 5: | *10.6 | ↗ | | | | | | | | | | | | | | | | | | | | | | | | | | | | | |
| 6: | 10.4 | ↘ | | | | | | | | | | | | | | | | | | | | | | | | | | | | | |
| 7: | 10.1 | ↗ | | | | | | | | | | | | | | | | | | | | | | | | | | | | | |
| 8: | *10.6 | ↗ | | | | | | | | | | | | | | | | | | | | | | | | | | | | | |
| 9: | *10.6 | ↗ | | | | | | | | | | | | | | | | | | | | | | | | | | | | | |
| 10: | *10.7 | ↗ | | | | | | | | | | | | | | | | | | | | | | | | | | | | | |
| <table style="width:100%; border-collapse: collapse;"> <tr> <td style="width:90%;">Serie</td> <td style="width:10%; text-align: right;">100.0</td> </tr> <tr> <td>Total</td> <td style="text-align: right;">100.0</td> </tr> </table> | | Serie | 100.0 | Total | 100.0 | | | | | | | | | | | | | | | | | | | | | | | | | | |
| Serie | 100.0 | | | | | | | | | | | | | | | | | | | | | | | | | | | | | | |
| Total | 100.0 | | | | | | | | | | | | | | | | | | | | | | | | | | | | | | |

| | | | | | | | | | | | | | | | | | | | | | | | | | | | | | | | |
|--|--|-------|------|-------|-------|-------|---|-----|-------|---|-----|------|---|-----|-------|---|-----|------|---|-----|-----|---|-----|-------|---|-----|-------|---|-----|------|---|
| <p>20 Skud</p> | <table style="width:100%; border-collapse: collapse;"> <tr><td style="width:10%;">11:</td><td style="width:15%;">10.3</td><td style="width:10%; text-align: right;">→</td></tr> <tr><td>12:</td><td>*10.9</td><td style="text-align: right;">↗</td></tr> <tr><td>13:</td><td>*10.8</td><td style="text-align: right;">←</td></tr> <tr><td>14:</td><td>10.5</td><td style="text-align: right;">↗</td></tr> <tr><td>15:</td><td>*10.9</td><td style="text-align: right;">↘</td></tr> <tr><td>16:</td><td>10.5</td><td style="text-align: right;">←</td></tr> <tr><td>17:</td><td>9.9</td><td style="text-align: right;">↗</td></tr> <tr><td>18:</td><td>*10.6</td><td style="text-align: right;">↗</td></tr> <tr><td>19:</td><td>*10.6</td><td style="text-align: right;">↗</td></tr> <tr><td>20:</td><td>10.2</td><td style="text-align: right;">↗</td></tr> </table> | 11: | 10.3 | → | 12: | *10.9 | ↗ | 13: | *10.8 | ← | 14: | 10.5 | ↗ | 15: | *10.9 | ↘ | 16: | 10.5 | ← | 17: | 9.9 | ↗ | 18: | *10.6 | ↗ | 19: | *10.6 | ↗ | 20: | 10.2 | ↗ |
| 11: | 10.3 | → | | | | | | | | | | | | | | | | | | | | | | | | | | | | | |
| 12: | *10.9 | ↗ | | | | | | | | | | | | | | | | | | | | | | | | | | | | | |
| 13: | *10.8 | ← | | | | | | | | | | | | | | | | | | | | | | | | | | | | | |
| 14: | 10.5 | ↗ | | | | | | | | | | | | | | | | | | | | | | | | | | | | | |
| 15: | *10.9 | ↘ | | | | | | | | | | | | | | | | | | | | | | | | | | | | | |
| 16: | 10.5 | ← | | | | | | | | | | | | | | | | | | | | | | | | | | | | | |
| 17: | 9.9 | ↗ | | | | | | | | | | | | | | | | | | | | | | | | | | | | | |
| 18: | *10.6 | ↗ | | | | | | | | | | | | | | | | | | | | | | | | | | | | | |
| 19: | *10.6 | ↗ | | | | | | | | | | | | | | | | | | | | | | | | | | | | | |
| 20: | 10.2 | ↗ | | | | | | | | | | | | | | | | | | | | | | | | | | | | | |
| <table style="width:100%; border-collapse: collapse;"> <tr> <td style="width:90%;">Serie</td> <td style="width:10%; text-align: right;">99.0</td> </tr> <tr> <td>Total</td> <td style="text-align: right;">199.0</td> </tr> </table> | | Serie | 99.0 | Total | 199.0 | | | | | | | | | | | | | | | | | | | | | | | | | | |
| Serie | 99.0 | | | | | | | | | | | | | | | | | | | | | | | | | | | | | | |
| Total | 199.0 | | | | | | | | | | | | | | | | | | | | | | | | | | | | | | |

Hold
24

Skive
6

Simon Mejdahl

Vilsted Skf.

MB2

Prøve

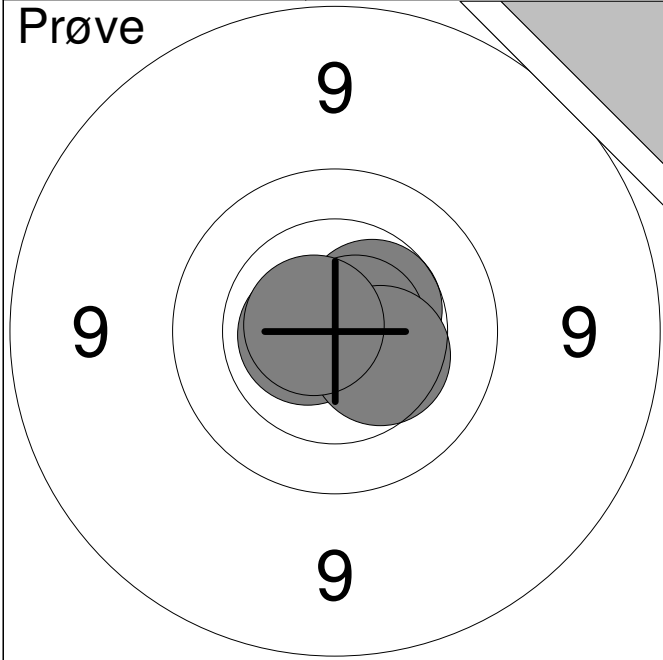

| | | |
|----|-------|---|
| 1: | 10.5 | ↗ |
| 2: | *10.7 | ↖ |
| 3: | *10.7 | ↗ |
| 4: | 10.4 | ↘ |
| 5: | *10.7 | ↖ |

| | |
|-------|------|
| Serie | 50.0 |
| Total | 0.0 |

20 Skud

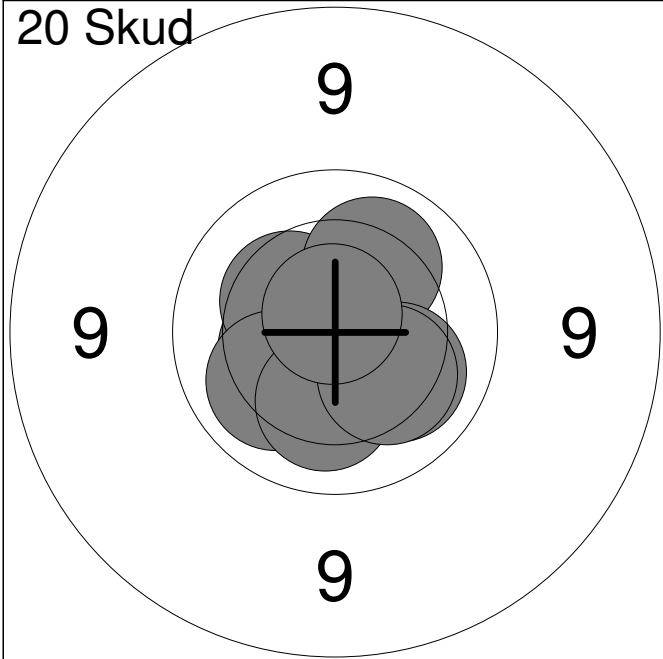

| | | |
|-----|-------|---|
| 1: | 10.4 | ↖ |
| 2: | *10.6 | ↘ |
| 3: | 10.3 | ↘ |
| 4: | 10.4 | ↗ |
| 5: | 10.1 | ↗ |
| 6: | 10.1 | ↖ |
| 7: | 10.2 | ↘ |
| 8: | 10.2 | ↘ |
| 9: | 10.2 | ↘ |
| 10: | *10.8 | ↗ |

| | |
|-------|-------|
| Serie | 100.0 |
| Total | 100.0 |

20 Skud

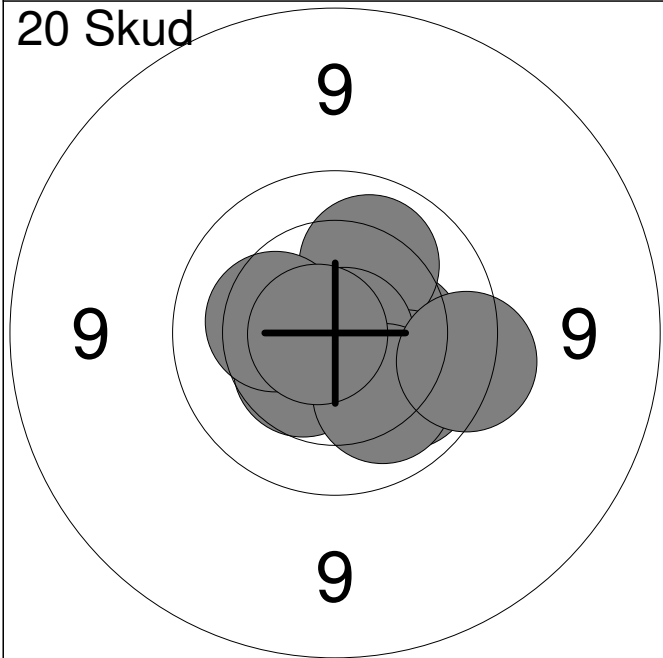

| | | |
|-----|-------|---|
| 11: | 10.3 | ↗ |
| 12: | 10.4 | ↖ |
| 13: | 10.4 | ↖ |
| 14: | 10.1 | ↗ |
| 15: | 10.3 | ↖ |
| 16: | 10.1 | ↘ |
| 17: | *10.8 | ↘ |
| 18: | 10.1 | ↘ |
| 19: | 9.7 | ↗ |
| 20: | *10.8 | ↖ |

| | |
|-------|-------|
| Serie | 99.0 |
| Total | 199.0 |

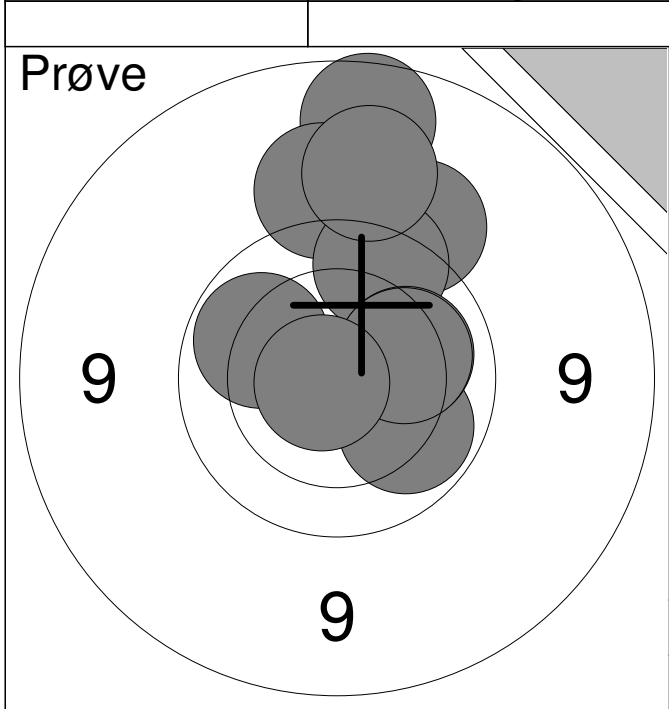

| | | |
|-------|-------|------|
| 1: | 9.4 | ↗ |
| 2: | 8.9 | ↑ |
| 3: | 9.3 | ↑ |
| 4: | 9.7 | ↗ |
| 5: | 9.2 | ↑ |
| 6: | 10.0 | ↘ |
| 7: | 10.1 | → |
| 8: | 10.2 | → |
| 9: | 10.0 | ↖ |
| 10: | *10.8 | ← |
| Serie | | 94.0 |
| Total | | 0.0 |

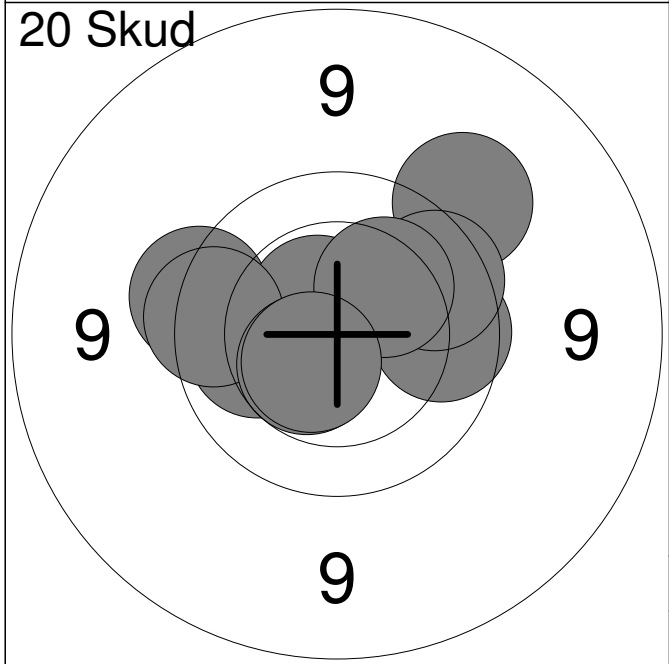

| | | |
|-------|-------|------|
| 1: | 9.6 | ← |
| 2: | 9.4 | ↗ |
| 3: | 10.1 | ← |
| 4: | *10.6 | ↗ |
| 5: | 9.8 | ← |
| 6: | 10.5 | ↘ |
| 7: | 9.9 | → |
| 8: | 9.8 | ↗ |
| 9: | 10.2 | ↗ |
| 10: | *10.5 | ↘ |
| Serie | | 95.0 |
| Total | | 95.0 |

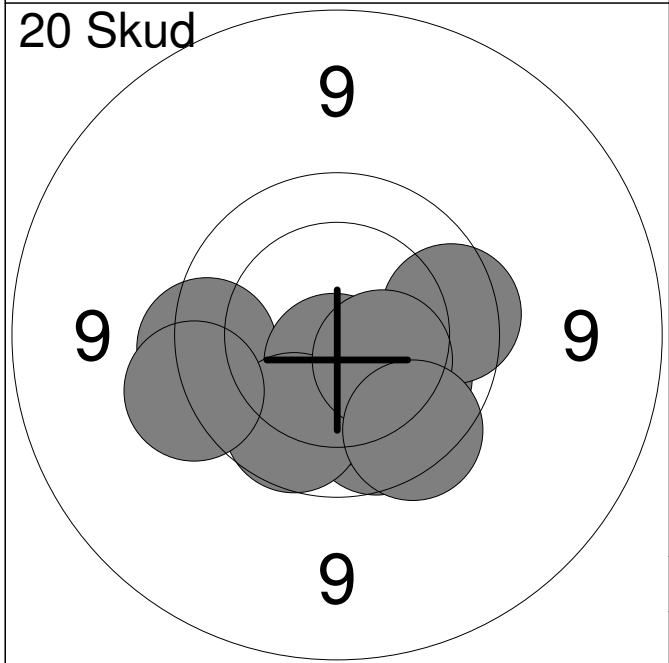

| | | |
|-------|-------|-------|
| 11: | 10.1 | ↘ |
| 12: | 9.8 | → |
| 13: | 9.9 | ↘ |
| 14: | 10.3 | ↘ |
| 15: | 9.7 | ← |
| 16: | *10.6 | ↘ |
| 17: | 9.9 | ↘ |
| 18: | 10.4 | ↘ |
| 19: | 9.8 | ↘ |
| 20: | 9.6 | ← |
| Serie | | 94.0 |
| Total | | 189.0 |

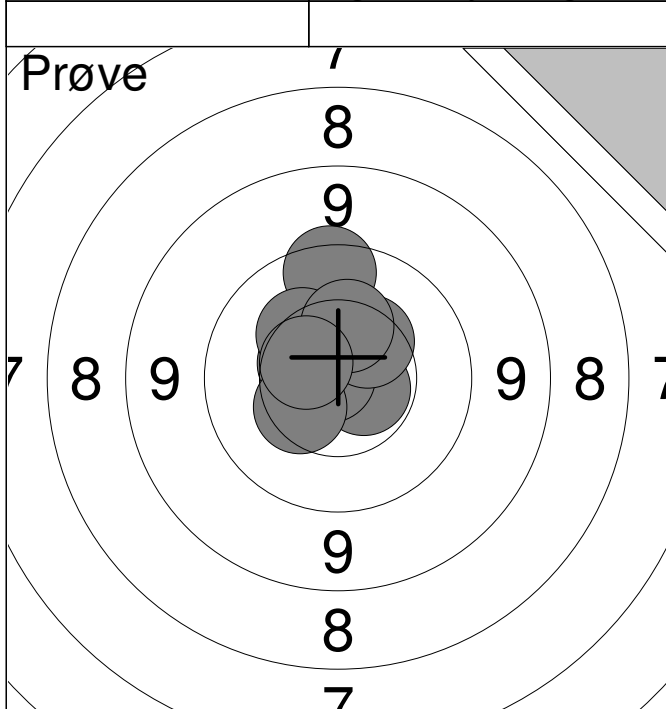

| | | |
|-------|-------|------|
| 1: | 10.5 | ↖ |
| 2: | 9.7 | ↑ |
| 3: | 10.3 | ↗ |
| 4: | *10.6 | ↘ |
| 5: | *10.8 | ← |
| 6: | 10.4 | ↗ |
| 7: | 10.3 | ↑ |
| 8: | 10.4 | ↖ |
| 9: | 10.5 | ↖ |
| Serie | | 89.0 |
| Total | | 0.0 |

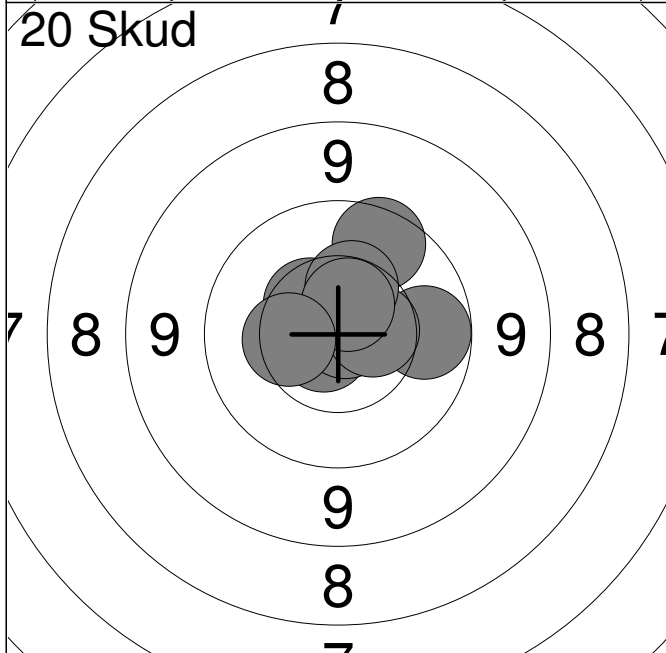

| | | |
|-------|-------|------|
| 1: | *10.7 | ↖ |
| 2: | *10.7 | ↗ |
| 3: | 10.5 | ↗ |
| 4: | 9.8 | ↗ |
| 5: | 10.0 | → |
| 6: | *10.9 | → |
| 7: | 10.5 | → |
| 8: | 10.4 | ↑ |
| 9: | *10.6 | ↑ |
| 10: | 10.4 | ← |
| Serie | | 99.0 |
| Total | | 99.0 |

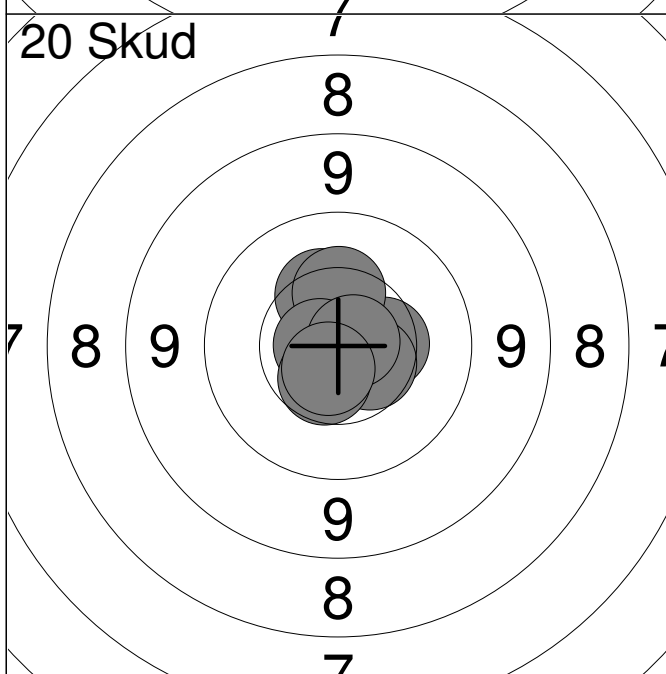

| | | |
|-------|-------|-------|
| 11: | *10.9 | ↖ |
| 12: | 10.3 | ↑ |
| 13: | 10.4 | → |
| 14: | 10.3 | ↑ |
| 15: | *10.9 | ↘ |
| 16: | 10.5 | ↘ |
| 17: | *10.7 | ← |
| 18: | *10.8 | → |
| 19: | 10.5 | ↘ |
| 20: | *10.7 | ↘ |
| Serie | | 100.0 |
| Total | | 199.0 |

Hold
24Skive
9**Rasmus Mikkelsen**

Vadum Skf.

BK2

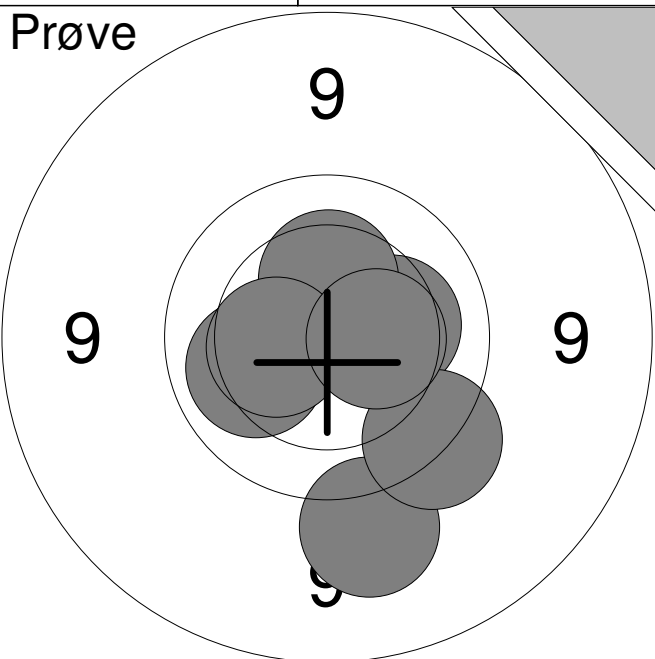
Prøve

| | |
|----|------|
| 1: | 9.3 |
| 2: | 10.2 |
| 3: | 9.6 |
| 4: | 10.3 |
| 5: | 10.1 |
| 6: | 10.4 |
| 7: | 10.4 |

| |
|---|
| ↓ |
| → |
| ↓ |
| ↑ |
| ← |
| ← |
| → |

Serie 68.0

Total 0.0

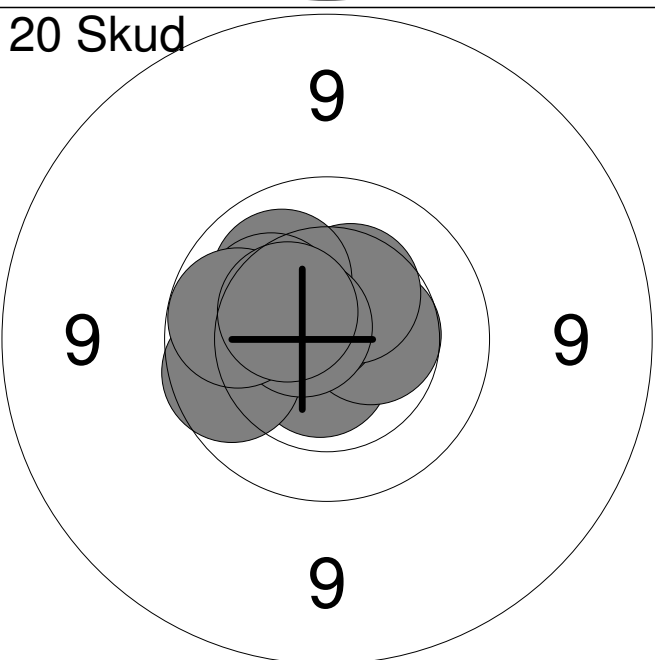
20 Skud

| | |
|-----|-------|
| 1: | *10.6 |
| 2: | 10.5 |
| 3: | *10.6 |
| 4: | 10.4 |
| 5: | 10.1 |
| 6: | 9.9 |
| 7: | 10.2 |
| 8: | *10.7 |
| 9: | 10.0 |
| 10: | 10.4 |

| |
|---|
| ↓ |
| → |
| ↗ |
| ↗ |
| ↗ |
| ← |
| ↗ |
| ↗ |
| ↗ |
| ↗ |

Serie 99.0

Total 99.0

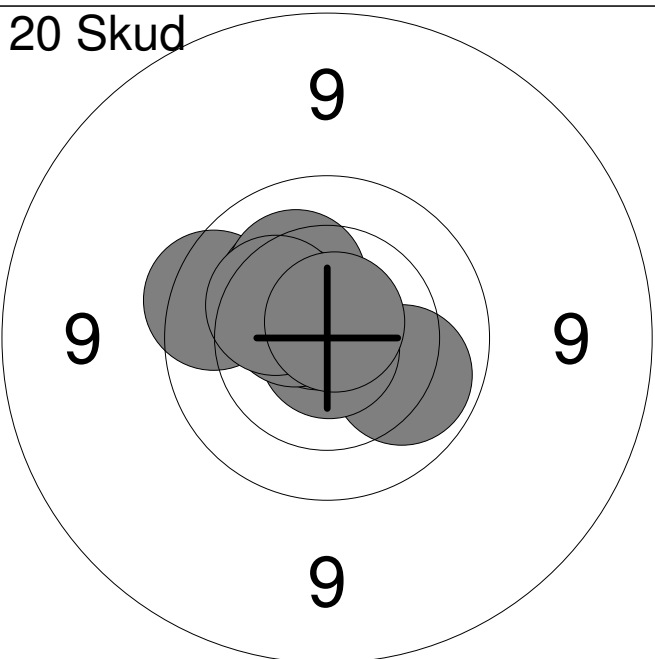
20 Skud

| | |
|-----|-------|
| 11: | 10.4 |
| 12: | 9.8 |
| 13: | 10.1 |
| 14: | *10.8 |
| 15: | 10.3 |
| 16: | *10.7 |
| 17: | 10.2 |
| 18: | *10.5 |
| 19: | 10.3 |
| 20: | *10.8 |

| |
|---|
| ↗ |
| ↗ |
| ↓ |
| ← |
| ↗ |
| ↗ |
| ↗ |
| ↗ |
| ↗ |
| ↗ |

Serie 99.0

Total 198.0

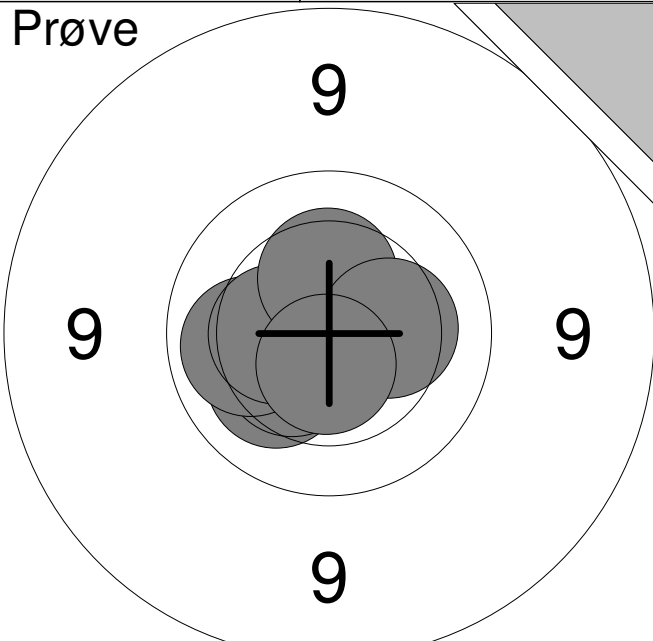
| | | | | | | | | | | | | | | | | | | | | | | | | | | | | | | | | |
|--|---|----|------|---|----|-------|---|----|------|---|----|-------|---|----|------|---|----|------|---|----|------|---|----|------|---|----|-------|---|-------|------|-------|-----|
| <p>Prøve</p>  | <table style="width:100%; border-collapse: collapse;"> <tr><td style="text-align: right;">1:</td><td style="text-align: right;">10.2</td><td style="text-align: right;">↙</td></tr> <tr><td style="text-align: right;">2:</td><td style="text-align: right;">*10.7</td><td style="text-align: right;">↗</td></tr> <tr><td style="text-align: right;">3:</td><td style="text-align: right;">10.4</td><td style="text-align: right;">↙</td></tr> <tr><td style="text-align: right;">4:</td><td style="text-align: right;">*10.8</td><td style="text-align: right;">↘</td></tr> <tr><td style="text-align: right;">5:</td><td style="text-align: right;">10.1</td><td style="text-align: right;">←</td></tr> <tr><td style="text-align: right;">6:</td><td style="text-align: right;">10.4</td><td style="text-align: right;">←</td></tr> <tr><td style="text-align: right;">7:</td><td style="text-align: right;">10.4</td><td style="text-align: right;">↑</td></tr> <tr><td style="text-align: right;">8:</td><td style="text-align: right;">10.3</td><td style="text-align: right;">→</td></tr> <tr><td style="text-align: right;">9:</td><td style="text-align: right;">*10.6</td><td style="text-align: right;">↓</td></tr> </table> <table border="1" style="width:100%; border-collapse: collapse; margin-top: 5px;"> <tr> <td style="width:80%;">Serie</td> <td style="text-align: right;">90.0</td> </tr> <tr> <td>Total</td> <td style="text-align: right;">0.0</td> </tr> </table> | 1: | 10.2 | ↙ | 2: | *10.7 | ↗ | 3: | 10.4 | ↙ | 4: | *10.8 | ↘ | 5: | 10.1 | ← | 6: | 10.4 | ← | 7: | 10.4 | ↑ | 8: | 10.3 | → | 9: | *10.6 | ↓ | Serie | 90.0 | Total | 0.0 |
| 1: | 10.2 | ↙ | | | | | | | | | | | | | | | | | | | | | | | | | | | | | | |
| 2: | *10.7 | ↗ | | | | | | | | | | | | | | | | | | | | | | | | | | | | | | |
| 3: | 10.4 | ↙ | | | | | | | | | | | | | | | | | | | | | | | | | | | | | | |
| 4: | *10.8 | ↘ | | | | | | | | | | | | | | | | | | | | | | | | | | | | | | |
| 5: | 10.1 | ← | | | | | | | | | | | | | | | | | | | | | | | | | | | | | | |
| 6: | 10.4 | ← | | | | | | | | | | | | | | | | | | | | | | | | | | | | | | |
| 7: | 10.4 | ↑ | | | | | | | | | | | | | | | | | | | | | | | | | | | | | | |
| 8: | 10.3 | → | | | | | | | | | | | | | | | | | | | | | | | | | | | | | | |
| 9: | *10.6 | ↓ | | | | | | | | | | | | | | | | | | | | | | | | | | | | | | |
| Serie | 90.0 | | | | | | | | | | | | | | | | | | | | | | | | | | | | | | | |
| Total | 0.0 | | | | | | | | | | | | | | | | | | | | | | | | | | | | | | | |

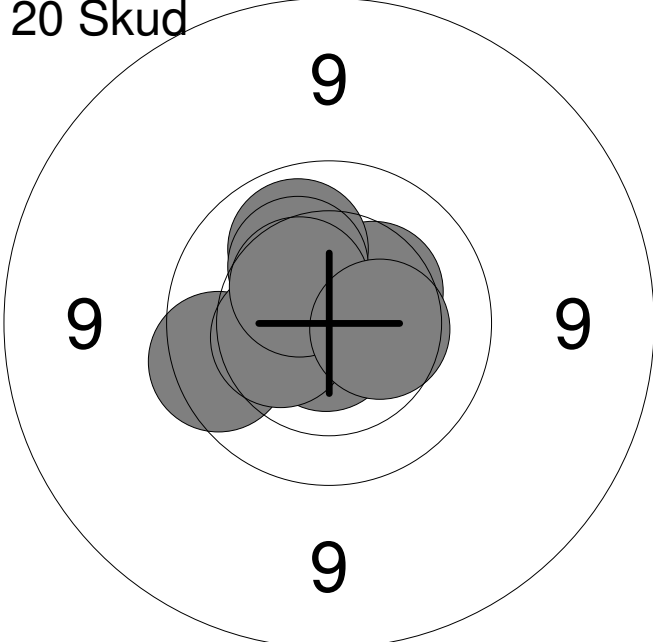
| | | | | | | | | | | | | | | | | | | | | | | | | | | | | | | | | | | | |
|---|---|----|-------|---|----|-------|---|----|------|---|----|-------|---|----|-----|---|----|------|---|----|------|---|----|------|---|----|------|---|-----|------|---|-------|------|-------|------|
| <p>20 Skud</p>  | <table style="width:100%; border-collapse: collapse;"> <tr><td style="text-align: right;">1:</td><td style="text-align: right;">*10.7</td><td style="text-align: right;">↓</td></tr> <tr><td style="text-align: right;">2:</td><td style="text-align: right;">*10.8</td><td style="text-align: right;">↑</td></tr> <tr><td style="text-align: right;">3:</td><td style="text-align: right;">10.4</td><td style="text-align: right;">↗</td></tr> <tr><td style="text-align: right;">4:</td><td style="text-align: right;">*10.6</td><td style="text-align: right;">←</td></tr> <tr><td style="text-align: right;">5:</td><td style="text-align: right;">9.8</td><td style="text-align: right;">←</td></tr> <tr><td style="text-align: right;">6:</td><td style="text-align: right;">10.4</td><td style="text-align: right;">←</td></tr> <tr><td style="text-align: right;">7:</td><td style="text-align: right;">10.1</td><td style="text-align: right;">↑</td></tr> <tr><td style="text-align: right;">8:</td><td style="text-align: right;">10.3</td><td style="text-align: right;">↗</td></tr> <tr><td style="text-align: right;">9:</td><td style="text-align: right;">10.4</td><td style="text-align: right;">↗</td></tr> <tr><td style="text-align: right;">10:</td><td style="text-align: right;">10.4</td><td style="text-align: right;">→</td></tr> </table> <table border="1" style="width:100%; border-collapse: collapse; margin-top: 5px;"> <tr> <td style="width:80%;">Serie</td> <td style="text-align: right;">99.0</td> </tr> <tr> <td>Total</td> <td style="text-align: right;">99.0</td> </tr> </table> | 1: | *10.7 | ↓ | 2: | *10.8 | ↑ | 3: | 10.4 | ↗ | 4: | *10.6 | ← | 5: | 9.8 | ← | 6: | 10.4 | ← | 7: | 10.1 | ↑ | 8: | 10.3 | ↗ | 9: | 10.4 | ↗ | 10: | 10.4 | → | Serie | 99.0 | Total | 99.0 |
| 1: | *10.7 | ↓ | | | | | | | | | | | | | | | | | | | | | | | | | | | | | | | | | |
| 2: | *10.8 | ↑ | | | | | | | | | | | | | | | | | | | | | | | | | | | | | | | | | |
| 3: | 10.4 | ↗ | | | | | | | | | | | | | | | | | | | | | | | | | | | | | | | | | |
| 4: | *10.6 | ← | | | | | | | | | | | | | | | | | | | | | | | | | | | | | | | | | |
| 5: | 9.8 | ← | | | | | | | | | | | | | | | | | | | | | | | | | | | | | | | | | |
| 6: | 10.4 | ← | | | | | | | | | | | | | | | | | | | | | | | | | | | | | | | | | |
| 7: | 10.1 | ↑ | | | | | | | | | | | | | | | | | | | | | | | | | | | | | | | | | |
| 8: | 10.3 | ↗ | | | | | | | | | | | | | | | | | | | | | | | | | | | | | | | | | |
| 9: | 10.4 | ↗ | | | | | | | | | | | | | | | | | | | | | | | | | | | | | | | | | |
| 10: | 10.4 | → | | | | | | | | | | | | | | | | | | | | | | | | | | | | | | | | | |
| Serie | 99.0 | | | | | | | | | | | | | | | | | | | | | | | | | | | | | | | | | | |
| Total | 99.0 | | | | | | | | | | | | | | | | | | | | | | | | | | | | | | | | | | |

| | | | | | | | | | | | | | | | | | | | | | | | | | | | | | | | | | | | |
|--|--|-----|-------|---|-----|-------|---|-----|------|---|-----|-------|---|-----|-------|---|-----|------|---|-----|-------|---|-----|-------|---|-----|-------|---|-----|-------|---|-------|-------|-------|-------|
| <p>20 Skud</p>  | <table style="width:100%; border-collapse: collapse;"> <tr><td style="text-align: right;">11:</td><td style="text-align: right;">*10.5</td><td style="text-align: right;">↓</td></tr> <tr><td style="text-align: right;">12:</td><td style="text-align: right;">*10.7</td><td style="text-align: right;">↘</td></tr> <tr><td style="text-align: right;">13:</td><td style="text-align: right;">10.4</td><td style="text-align: right;">↗</td></tr> <tr><td style="text-align: right;">14:</td><td style="text-align: right;">*10.5</td><td style="text-align: right;">↑</td></tr> <tr><td style="text-align: right;">15:</td><td style="text-align: right;">*10.8</td><td style="text-align: right;">↗</td></tr> <tr><td style="text-align: right;">16:</td><td style="text-align: right;">10.5</td><td style="text-align: right;">←</td></tr> <tr><td style="text-align: right;">17:</td><td style="text-align: right;">*10.8</td><td style="text-align: right;">↘</td></tr> <tr><td style="text-align: right;">18:</td><td style="text-align: right;">*10.8</td><td style="text-align: right;">↙</td></tr> <tr><td style="text-align: right;">19:</td><td style="text-align: right;">*10.5</td><td style="text-align: right;">↗</td></tr> <tr><td style="text-align: right;">20:</td><td style="text-align: right;">*10.6</td><td style="text-align: right;">↗</td></tr> </table> <table border="1" style="width:100%; border-collapse: collapse; margin-top: 5px;"> <tr> <td style="width:80%;">Serie</td> <td style="text-align: right;">100.0</td> </tr> <tr> <td>Total</td> <td style="text-align: right;">199.0</td> </tr> </table> | 11: | *10.5 | ↓ | 12: | *10.7 | ↘ | 13: | 10.4 | ↗ | 14: | *10.5 | ↑ | 15: | *10.8 | ↗ | 16: | 10.5 | ← | 17: | *10.8 | ↘ | 18: | *10.8 | ↙ | 19: | *10.5 | ↗ | 20: | *10.6 | ↗ | Serie | 100.0 | Total | 199.0 |
| 11: | *10.5 | ↓ | | | | | | | | | | | | | | | | | | | | | | | | | | | | | | | | | |
| 12: | *10.7 | ↘ | | | | | | | | | | | | | | | | | | | | | | | | | | | | | | | | | |
| 13: | 10.4 | ↗ | | | | | | | | | | | | | | | | | | | | | | | | | | | | | | | | | |
| 14: | *10.5 | ↑ | | | | | | | | | | | | | | | | | | | | | | | | | | | | | | | | | |
| 15: | *10.8 | ↗ | | | | | | | | | | | | | | | | | | | | | | | | | | | | | | | | | |
| 16: | 10.5 | ← | | | | | | | | | | | | | | | | | | | | | | | | | | | | | | | | | |
| 17: | *10.8 | ↘ | | | | | | | | | | | | | | | | | | | | | | | | | | | | | | | | | |
| 18: | *10.8 | ↙ | | | | | | | | | | | | | | | | | | | | | | | | | | | | | | | | | |
| 19: | *10.5 | ↗ | | | | | | | | | | | | | | | | | | | | | | | | | | | | | | | | | |
| 20: | *10.6 | ↗ | | | | | | | | | | | | | | | | | | | | | | | | | | | | | | | | | |
| Serie | 100.0 | | | | | | | | | | | | | | | | | | | | | | | | | | | | | | | | | | |
| Total | 199.0 | | | | | | | | | | | | | | | | | | | | | | | | | | | | | | | | | | |

Hold
24

Skive
11

Emma Myrup Langgaard

Løgstør Skyttelaug

BK2

Prøve

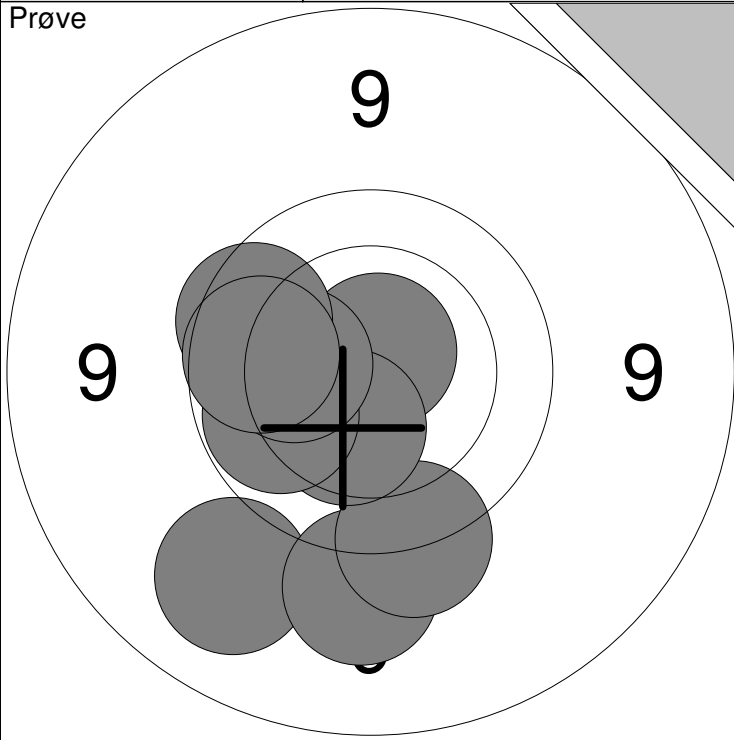

Prøve

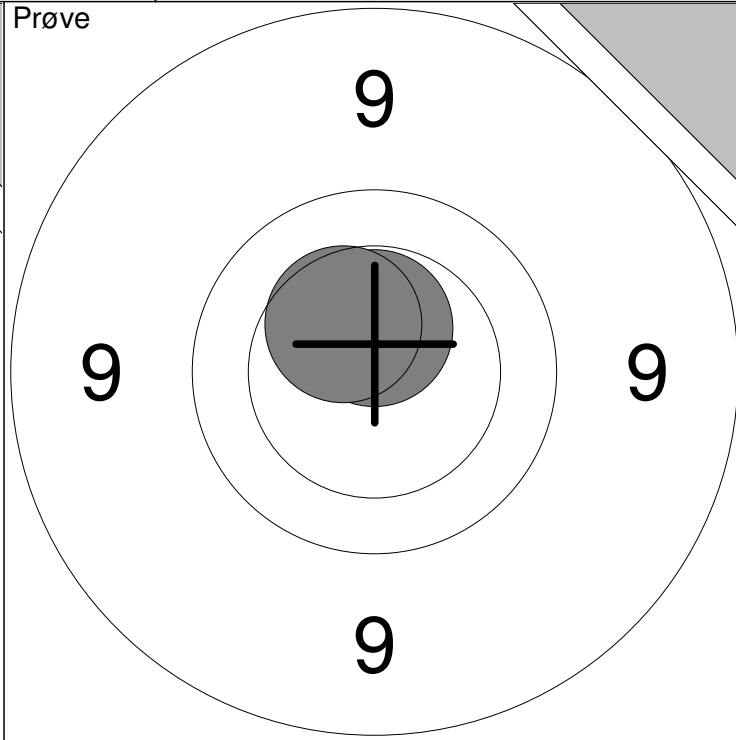

| | |
|------------|-----------|
| 1: 9.2 ↘ | 6: 10.4 ↓ |
| 2: 9.3 ↓ | 7: 10.0 ↙ |
| 3: 9.6 ↓ | 8: 10.2 ← |
| 4: 10.3 ↙ | 9: 9.8 ↖ |
| 5: *10.7 ↑ | 10: 9.9 ← |

| | |
|-------|------|
| Serie | 95.0 |
| Total | 0.0 |

| |
|-------------|
| 11: *10.5 ↑ |
| 12: 10.4 ↖ |

| | |
|-------|------|
| Serie | 20.0 |
| Total | 0.0 |

20 Skud

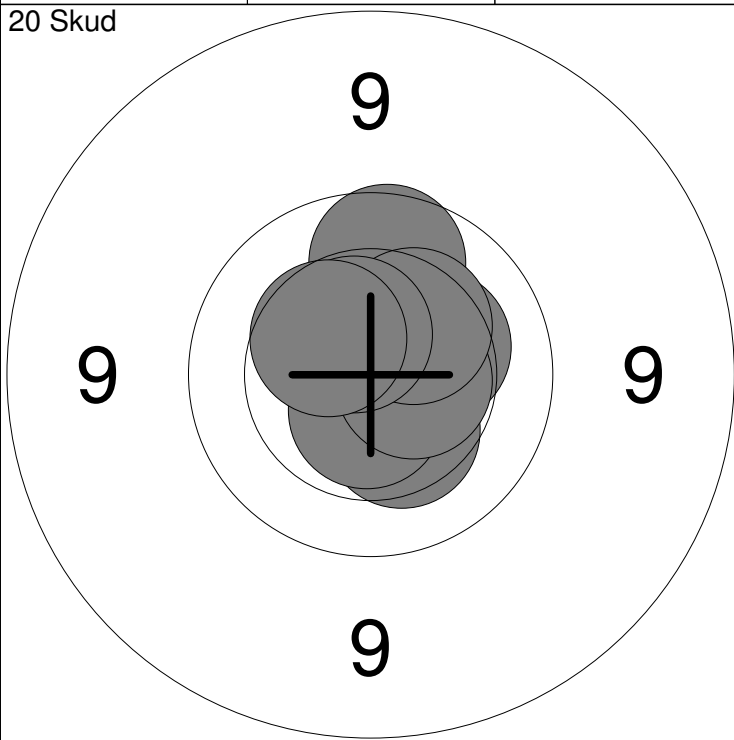

20 Skud

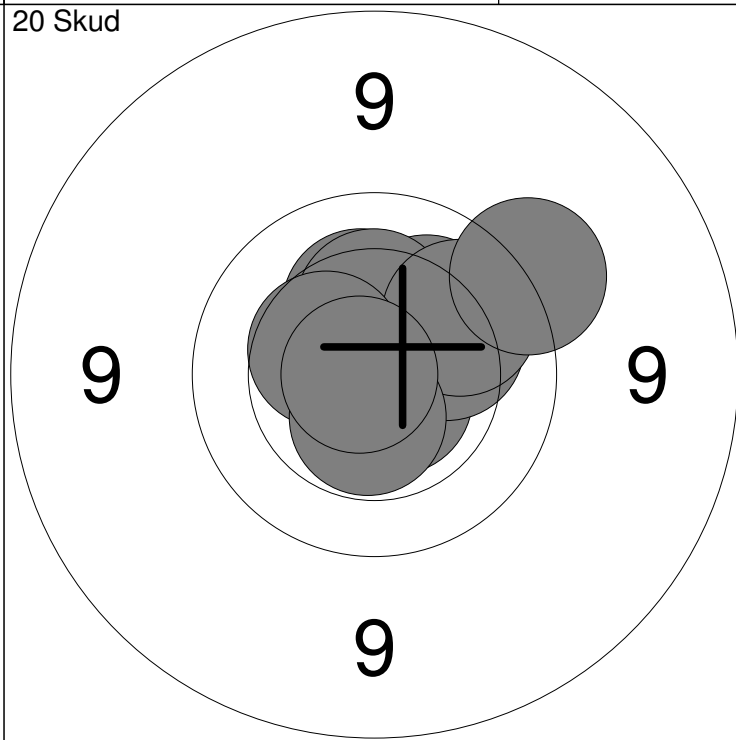

| | |
|------------|------------|
| 1: 10.4 ↗ | 6: *10.5 → |
| 2: 10.3 → | 7: 9.9 ↑ |
| 3: *10.5 ↑ | 8: 10.3 ↗ |
| 4: 10.3 ↓ | 9: *10.5 ↑ |
| 5: *10.6 ↓ | 10: 10.4 ↖ |

| | |
|-------|------|
| Serie | 99.0 |
| Total | 99.0 |

| | |
|-------------|-------------|
| 11: *10.7 ↓ | 16: 10.0 ↗ |
| 12: 10.3 ↑ | 17: 10.4 ↖ |
| 13: 10.2 → | 18: *10.5 ↓ |
| 14: 10.2 ↗ | 19: *10.8 ← |
| 15: 10.3 ↑ | 20: 9.5 ↗ |

| | |
|-------|-------|
| Serie | 99.0 |
| Total | 198.0 |

Hold
24

Skive
12

Frederik B. Sørensen

Løgstør Skyttelaug

BK1

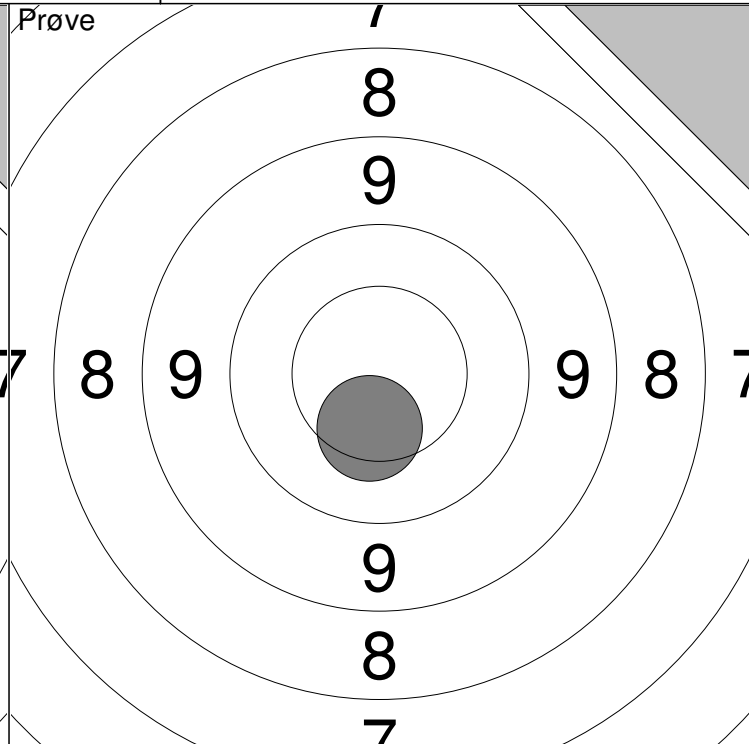
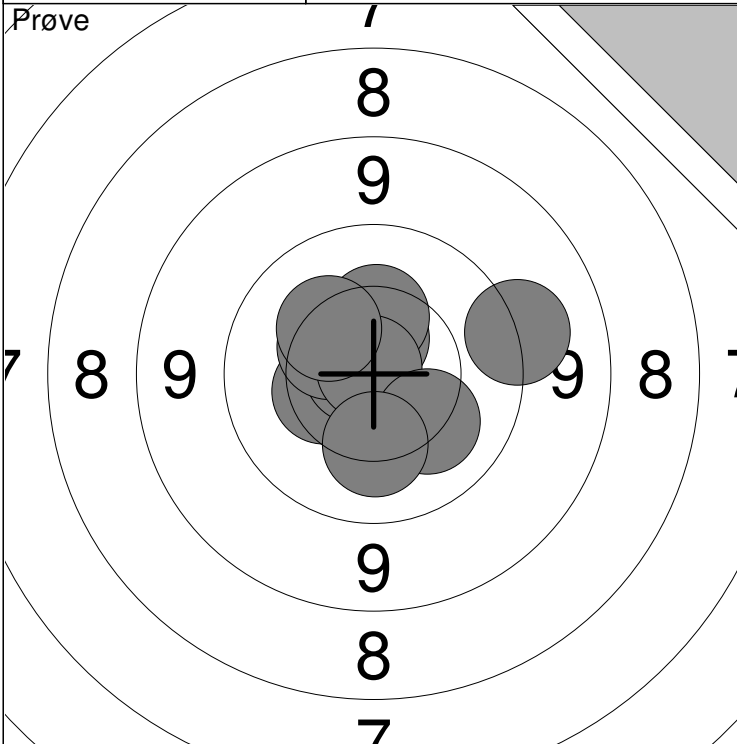

1: 10.6 ↑
 2: 10.4 ↑
 3: 10.4 ←
 4: *10.8 ←
 5: 10.4 ↖

6: *10.9 ↗
 7: 10.2 ↘
 8: 10.2 ↓
 9: 9.4 →
 10: 10.3 ↗

Serie 99.0
 Total 0.0

11: 10.4 ↓

Serie 10.0
 Total 0.0

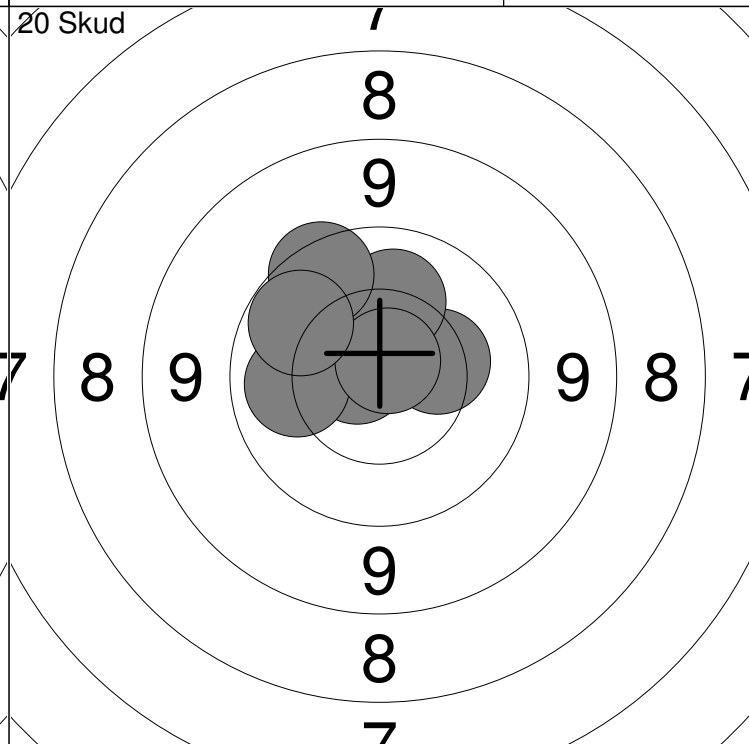
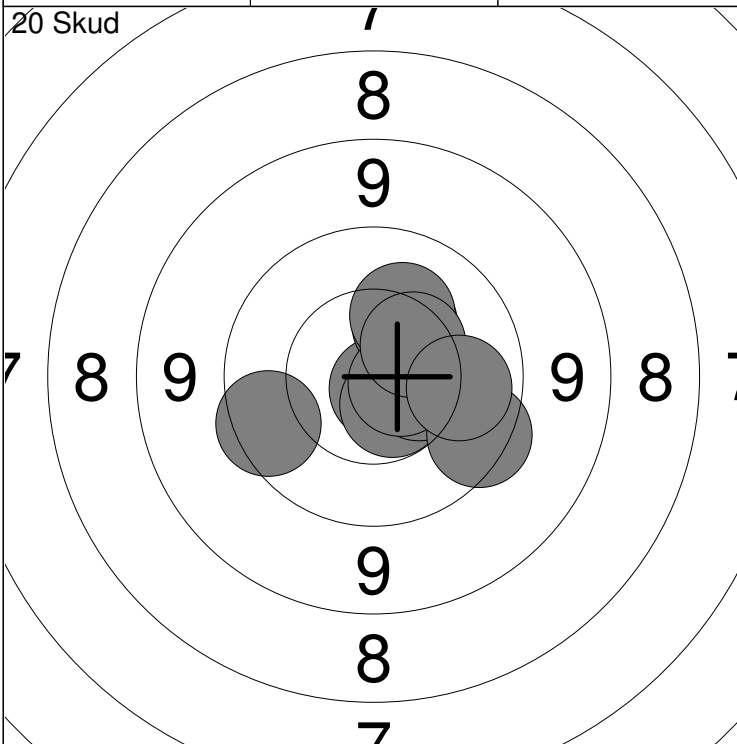

1: *10.8 ↓
 2: 9.7 ←
 3: 10.3 ↗
 4: *10.6 ↓
 5: 10.5 →

6: 10.3 ↗
 7: 9.7 ↘
 8: *10.7 →
 9: 10.4 ↗
 10: 10.1 →

Serie 98.0
 Total 98.0

11: 10.3 →
 12: *10.7 ↑
 13: *10.7 ↗
 14: 10.4 ↗
 15: *10.7 ←

16: 10.1 ←
 17: 10.2 ↑
 18: 9.7 ↗
 19: *10.8 ↗
 20: 10.0 ←

Serie 99.0
 Total 197.0

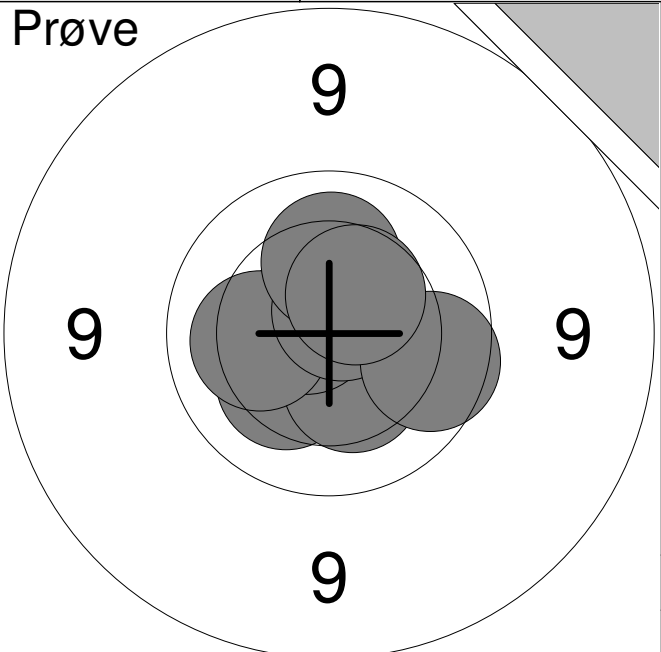
| | | | | | | | | | | | | | | | | | | | | | | | | | |
|--|--|----|------|---|----|------|---|----|-------|---|----|------|---|----|-------|---|----|-----|---|----|------|---|----|------|---|
| <p>Prøve</p>  | <table style="width:100%; border-collapse: collapse;"> <tr><td style="width:5%;">1:</td><td style="width:15%;">10.3</td><td style="width:10%; text-align: center;">↙</td></tr> <tr><td>2:</td><td>10.4</td><td style="text-align: center;">↓</td></tr> <tr><td>3:</td><td>*10.7</td><td style="text-align: center;">↖</td></tr> <tr><td>4:</td><td>10.2</td><td style="text-align: center;">←</td></tr> <tr><td>5:</td><td>*10.7</td><td style="text-align: center;">↗</td></tr> <tr><td>6:</td><td>9.9</td><td style="text-align: center;">→</td></tr> <tr><td>7:</td><td>10.2</td><td style="text-align: center;">↑</td></tr> <tr><td>8:</td><td>10.4</td><td style="text-align: center;">↗</td></tr> </table> | 1: | 10.3 | ↙ | 2: | 10.4 | ↓ | 3: | *10.7 | ↖ | 4: | 10.2 | ← | 5: | *10.7 | ↗ | 6: | 9.9 | → | 7: | 10.2 | ↑ | 8: | 10.4 | ↗ |
| 1: | 10.3 | ↙ | | | | | | | | | | | | | | | | | | | | | | | |
| 2: | 10.4 | ↓ | | | | | | | | | | | | | | | | | | | | | | | |
| 3: | *10.7 | ↖ | | | | | | | | | | | | | | | | | | | | | | | |
| 4: | 10.2 | ← | | | | | | | | | | | | | | | | | | | | | | | |
| 5: | *10.7 | ↗ | | | | | | | | | | | | | | | | | | | | | | | |
| 6: | 9.9 | → | | | | | | | | | | | | | | | | | | | | | | | |
| 7: | 10.2 | ↑ | | | | | | | | | | | | | | | | | | | | | | | |
| 8: | 10.4 | ↗ | | | | | | | | | | | | | | | | | | | | | | | |
| | Serie 79.0 | | | | | | | | | | | | | | | | | | | | | | | | |
| | Total 0.0 | | | | | | | | | | | | | | | | | | | | | | | | |

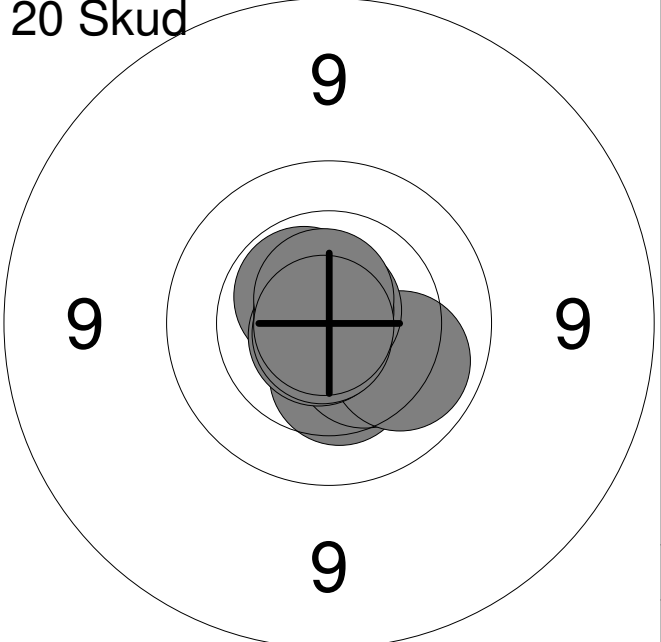
| | | | | | | | | | | | | | | | | | | | | | | | | | | | | | | | |
|---|---|----|-------|---|----|------|---|----|------|---|----|------|---|----|-------|---|----|-------|---|----|-------|---|----|-------|---|----|-------|---|-----|-------|---|
| <p>20 Skud</p>  | <table style="width:100%; border-collapse: collapse;"> <tr><td style="width:5%;">1:</td><td style="width:15%;">*10.6</td><td style="width:10%; text-align: center;">↗</td></tr> <tr><td>2:</td><td>10.4</td><td style="text-align: center;">↓</td></tr> <tr><td>3:</td><td>10.4</td><td style="text-align: center;">↓</td></tr> <tr><td>4:</td><td>10.1</td><td style="text-align: center;">↓</td></tr> <tr><td>5:</td><td>*10.8</td><td style="text-align: center;">↙</td></tr> <tr><td>6:</td><td>*10.8</td><td style="text-align: center;">↑</td></tr> <tr><td>7:</td><td>*10.8</td><td style="text-align: center;">↙</td></tr> <tr><td>8:</td><td>*10.8</td><td style="text-align: center;">↑</td></tr> <tr><td>9:</td><td>*10.7</td><td style="text-align: center;">↑</td></tr> <tr><td>10:</td><td>*10.9</td><td style="text-align: center;">←</td></tr> </table> | 1: | *10.6 | ↗ | 2: | 10.4 | ↓ | 3: | 10.4 | ↓ | 4: | 10.1 | ↓ | 5: | *10.8 | ↙ | 6: | *10.8 | ↑ | 7: | *10.8 | ↙ | 8: | *10.8 | ↑ | 9: | *10.7 | ↑ | 10: | *10.9 | ← |
| 1: | *10.6 | ↗ | | | | | | | | | | | | | | | | | | | | | | | | | | | | | |
| 2: | 10.4 | ↓ | | | | | | | | | | | | | | | | | | | | | | | | | | | | | |
| 3: | 10.4 | ↓ | | | | | | | | | | | | | | | | | | | | | | | | | | | | | |
| 4: | 10.1 | ↓ | | | | | | | | | | | | | | | | | | | | | | | | | | | | | |
| 5: | *10.8 | ↙ | | | | | | | | | | | | | | | | | | | | | | | | | | | | | |
| 6: | *10.8 | ↑ | | | | | | | | | | | | | | | | | | | | | | | | | | | | | |
| 7: | *10.8 | ↙ | | | | | | | | | | | | | | | | | | | | | | | | | | | | | |
| 8: | *10.8 | ↑ | | | | | | | | | | | | | | | | | | | | | | | | | | | | | |
| 9: | *10.7 | ↑ | | | | | | | | | | | | | | | | | | | | | | | | | | | | | |
| 10: | *10.9 | ← | | | | | | | | | | | | | | | | | | | | | | | | | | | | | |
| | Serie 100.0 | | | | | | | | | | | | | | | | | | | | | | | | | | | | | | |
| | Total 100.0 | | | | | | | | | | | | | | | | | | | | | | | | | | | | | | |

| | | | | | | | | | | | | | | | | | | | | | | | | | | | | | | | |
|--|---|-----|------|---|-----|------|---|-----|-------|---|-----|-------|---|-----|-----|---|-----|-------|---|-----|-------|---|-----|-------|---|-----|------|---|-----|------|---|
| <p>20 Skud</p>  | <table style="width:100%; border-collapse: collapse;"> <tr><td style="width:5%;">11:</td><td style="width:15%;">10.4</td><td style="width:10%; text-align: center;">↓</td></tr> <tr><td>12:</td><td>10.5</td><td style="text-align: center;">←</td></tr> <tr><td>13:</td><td>*10.7</td><td style="text-align: center;">←</td></tr> <tr><td>14:</td><td>*10.7</td><td style="text-align: center;">→</td></tr> <tr><td>15:</td><td>9.8</td><td style="text-align: center;">↙</td></tr> <tr><td>16:</td><td>*10.6</td><td style="text-align: center;">↙</td></tr> <tr><td>17:</td><td>*10.6</td><td style="text-align: center;">→</td></tr> <tr><td>18:</td><td>*10.6</td><td style="text-align: center;">↓</td></tr> <tr><td>19:</td><td>10.5</td><td style="text-align: center;">↓</td></tr> <tr><td>20:</td><td>10.2</td><td style="text-align: center;">↓</td></tr> </table> | 11: | 10.4 | ↓ | 12: | 10.5 | ← | 13: | *10.7 | ← | 14: | *10.7 | → | 15: | 9.8 | ↙ | 16: | *10.6 | ↙ | 17: | *10.6 | → | 18: | *10.6 | ↓ | 19: | 10.5 | ↓ | 20: | 10.2 | ↓ |
| 11: | 10.4 | ↓ | | | | | | | | | | | | | | | | | | | | | | | | | | | | | |
| 12: | 10.5 | ← | | | | | | | | | | | | | | | | | | | | | | | | | | | | | |
| 13: | *10.7 | ← | | | | | | | | | | | | | | | | | | | | | | | | | | | | | |
| 14: | *10.7 | → | | | | | | | | | | | | | | | | | | | | | | | | | | | | | |
| 15: | 9.8 | ↙ | | | | | | | | | | | | | | | | | | | | | | | | | | | | | |
| 16: | *10.6 | ↙ | | | | | | | | | | | | | | | | | | | | | | | | | | | | | |
| 17: | *10.6 | → | | | | | | | | | | | | | | | | | | | | | | | | | | | | | |
| 18: | *10.6 | ↓ | | | | | | | | | | | | | | | | | | | | | | | | | | | | | |
| 19: | 10.5 | ↓ | | | | | | | | | | | | | | | | | | | | | | | | | | | | | |
| 20: | 10.2 | ↓ | | | | | | | | | | | | | | | | | | | | | | | | | | | | | |
| | Serie 99.0 | | | | | | | | | | | | | | | | | | | | | | | | | | | | | | |
| | Total 199.0 | | | | | | | | | | | | | | | | | | | | | | | | | | | | | | |

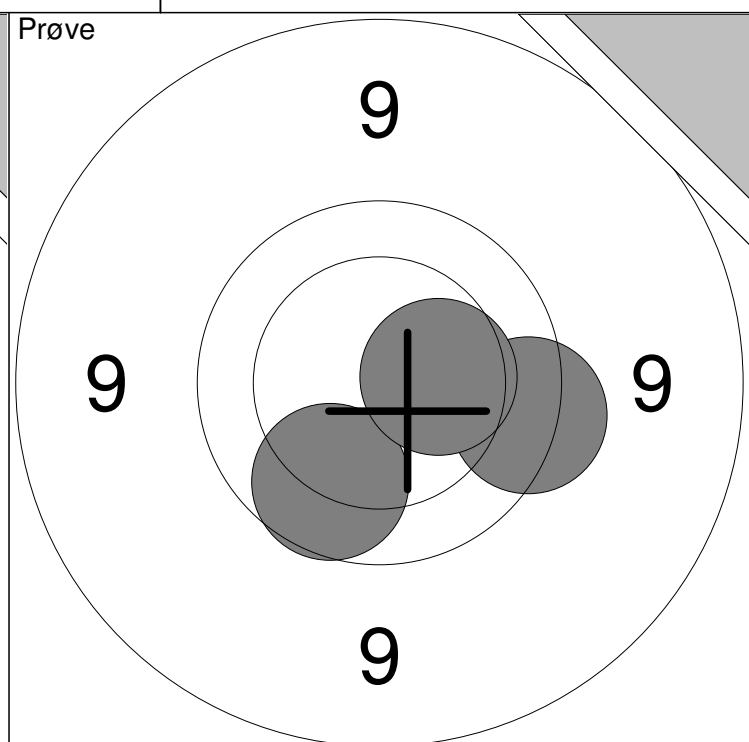
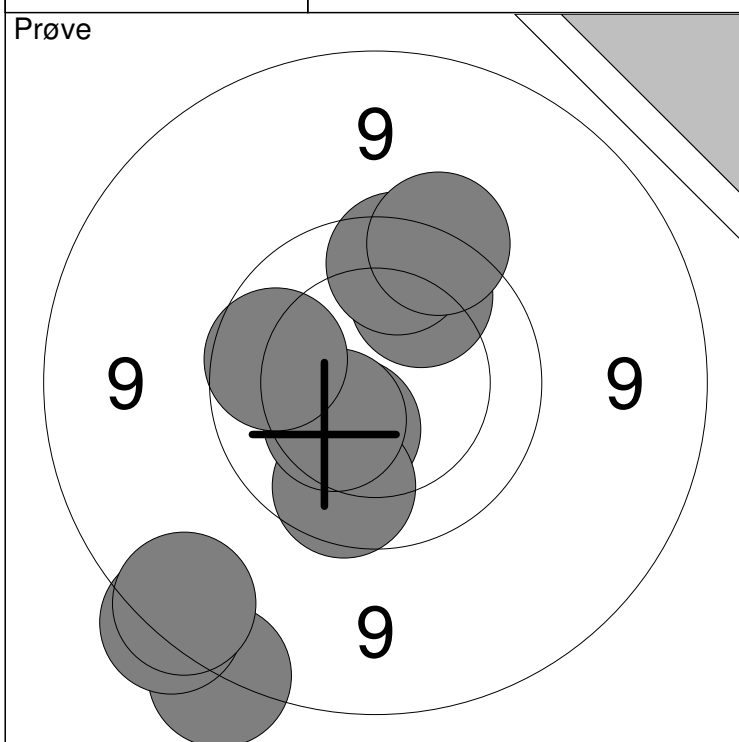

| | | | |
|-----------|-----------|-------|------|
| 1: 8.7 ↘ | 6: 10.4 ↙ | Serie | 89.0 |
| 2: 8.7 ↘ | 7: 9.9 ← | | |
| 3: 10.4 ↘ | 8: 9.9 ↗ | Total | 0.0 |
| 4: 8.8 ↘ | 9: 9.8 ↗ | | |
| 5: 9.9 ↘ | 10: 9.6 ↗ | | |

| | | |
|------------|-------|------|
| 11: 9.7 → | Serie | 28.0 |
| 12: 9.9 ↘ | | |
| 13: 10.4 → | Total | 0.0 |

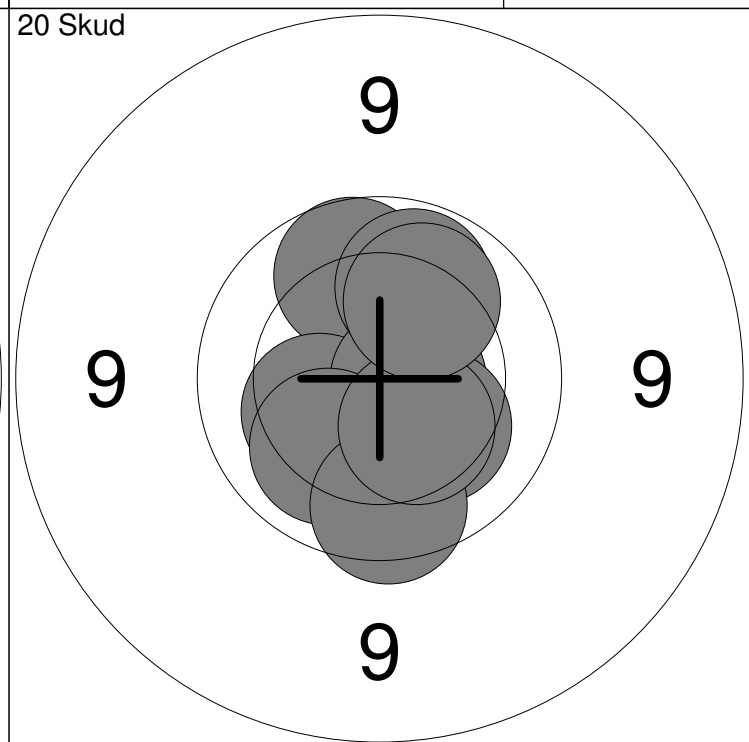
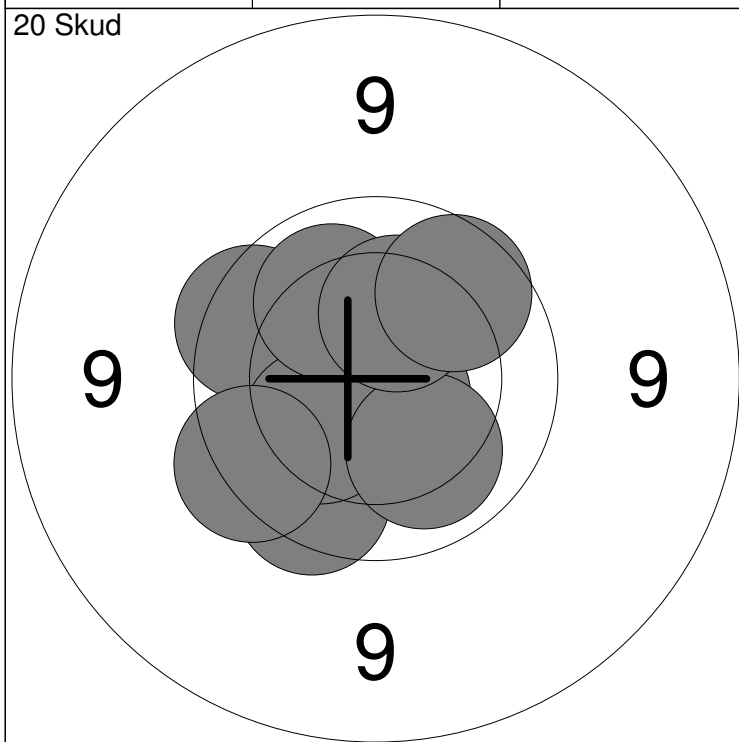

| | | | |
|------------|-----------|-------|------|
| 1: 9.8 ↘ | 6: 9.7 ↙ | Serie | 96.0 |
| 2: 10.3 ← | 7: 10.1 ↘ | | |
| 3: *10.7 ↘ | 8: 10.1 ↗ | Total | 96.0 |
| 4: 9.8 ← | 9: 10.3 ↗ | | |
| 5: 10.3 ↘ | 10: 9.9 ↗ | | |

| | | |
|-------------|-------|-------|
| 11: 9.9 ↗ | Serie | 98.0 |
| 12: 10.3 ↘ | | |
| 13: 10.3 ← | Total | 194.0 |
| 14: *10.7 → | | |
| 15: 10.3 ↘ | | |

| | | | | | | | | | | | | | | | | | | | | | | | |
|---------------------|--|----|------|---|----|-----|---|----|------|---|----|-------|---|----|-------|---|----|-------|---|-------|------|-------|-----|
| <p>Prøve</p> | <table style="width:100%; border-collapse: collapse;"> <tr><td style="width:10%;">1:</td><td style="width:15%;">10.2</td><td style="width:10%; text-align: right;">↙</td></tr> <tr><td>2:</td><td>9.9</td><td style="text-align: right;">↙</td></tr> <tr><td>3:</td><td>10.4</td><td style="text-align: right;">↙</td></tr> <tr><td>4:</td><td>*10.8</td><td style="text-align: right;">↗</td></tr> <tr><td>5:</td><td>*10.7</td><td style="text-align: right;">↗</td></tr> <tr><td>6:</td><td>*10.8</td><td style="text-align: right;">→</td></tr> </table> <table border="1" style="width:100%; border-collapse: collapse; margin-top: 5px;"> <tr> <td style="width:80%;">Serie</td> <td style="text-align: right;">59.0</td> </tr> <tr> <td>Total</td> <td style="text-align: right;">0.0</td> </tr> </table> | 1: | 10.2 | ↙ | 2: | 9.9 | ↙ | 3: | 10.4 | ↙ | 4: | *10.8 | ↗ | 5: | *10.7 | ↗ | 6: | *10.8 | → | Serie | 59.0 | Total | 0.0 |
| 1: | 10.2 | ↙ | | | | | | | | | | | | | | | | | | | | | |
| 2: | 9.9 | ↙ | | | | | | | | | | | | | | | | | | | | | |
| 3: | 10.4 | ↙ | | | | | | | | | | | | | | | | | | | | | |
| 4: | *10.8 | ↗ | | | | | | | | | | | | | | | | | | | | | |
| 5: | *10.7 | ↗ | | | | | | | | | | | | | | | | | | | | | |
| 6: | *10.8 | → | | | | | | | | | | | | | | | | | | | | | |
| Serie | 59.0 | | | | | | | | | | | | | | | | | | | | | | |
| Total | 0.0 | | | | | | | | | | | | | | | | | | | | | | |

| | | | | | | | | | | | | | | | | | | | | | | | | | | | | | | | | | | | |
|-----------------------|---|----|------|---|----|------|---|----|------|---|----|------|---|----|------|---|----|-------|---|----|------|---|----|------|---|----|-------|---|-----|-------|---|-------|-------|-------|-------|
| <p>20 Skud</p> | <table style="width:100%; border-collapse: collapse;"> <tr><td style="width:10%;">1:</td><td style="width:15%;">10.3</td><td style="width:10%; text-align: right;">↙</td></tr> <tr><td>2:</td><td>10.0</td><td style="text-align: right;">↑</td></tr> <tr><td>3:</td><td>10.0</td><td style="text-align: right;">↙</td></tr> <tr><td>4:</td><td>10.2</td><td style="text-align: right;">↑</td></tr> <tr><td>5:</td><td>10.4</td><td style="text-align: right;">→</td></tr> <tr><td>6:</td><td>*10.8</td><td style="text-align: right;">↙</td></tr> <tr><td>7:</td><td>10.0</td><td style="text-align: right;">→</td></tr> <tr><td>8:</td><td>10.4</td><td style="text-align: right;">↙</td></tr> <tr><td>9:</td><td>*10.8</td><td style="text-align: right;">↗</td></tr> <tr><td>10:</td><td>*10.5</td><td style="text-align: right;">↘</td></tr> </table> <table border="1" style="width:100%; border-collapse: collapse; margin-top: 5px;"> <tr> <td style="width:80%;">Serie</td> <td style="text-align: right;">100.0</td> </tr> <tr> <td>Total</td> <td style="text-align: right;">100.0</td> </tr> </table> | 1: | 10.3 | ↙ | 2: | 10.0 | ↑ | 3: | 10.0 | ↙ | 4: | 10.2 | ↑ | 5: | 10.4 | → | 6: | *10.8 | ↙ | 7: | 10.0 | → | 8: | 10.4 | ↙ | 9: | *10.8 | ↗ | 10: | *10.5 | ↘ | Serie | 100.0 | Total | 100.0 |
| 1: | 10.3 | ↙ | | | | | | | | | | | | | | | | | | | | | | | | | | | | | | | | | |
| 2: | 10.0 | ↑ | | | | | | | | | | | | | | | | | | | | | | | | | | | | | | | | | |
| 3: | 10.0 | ↙ | | | | | | | | | | | | | | | | | | | | | | | | | | | | | | | | | |
| 4: | 10.2 | ↑ | | | | | | | | | | | | | | | | | | | | | | | | | | | | | | | | | |
| 5: | 10.4 | → | | | | | | | | | | | | | | | | | | | | | | | | | | | | | | | | | |
| 6: | *10.8 | ↙ | | | | | | | | | | | | | | | | | | | | | | | | | | | | | | | | | |
| 7: | 10.0 | → | | | | | | | | | | | | | | | | | | | | | | | | | | | | | | | | | |
| 8: | 10.4 | ↙ | | | | | | | | | | | | | | | | | | | | | | | | | | | | | | | | | |
| 9: | *10.8 | ↗ | | | | | | | | | | | | | | | | | | | | | | | | | | | | | | | | | |
| 10: | *10.5 | ↘ | | | | | | | | | | | | | | | | | | | | | | | | | | | | | | | | | |
| Serie | 100.0 | | | | | | | | | | | | | | | | | | | | | | | | | | | | | | | | | | |
| Total | 100.0 | | | | | | | | | | | | | | | | | | | | | | | | | | | | | | | | | | |

| | | | | | | | | | | | | | | | | | | | | | | | | | | | | | | | | | | | |
|-----------------------|---|-----|-------|---|-----|------|---|-----|-------|---|-----|-------|---|-----|-------|---|-----|------|---|-----|------|---|-----|-------|---|-----|-------|---|-----|------|---|-------|-------|-------|-------|
| <p>20 Skud</p> | <table style="width:100%; border-collapse: collapse;"> <tr><td style="width:10%;">11:</td><td style="width:15%;">*10.6</td><td style="width:10%; text-align: right;">↙</td></tr> <tr><td>12:</td><td>10.4</td><td style="text-align: right;">↙</td></tr> <tr><td>13:</td><td>*10.5</td><td style="text-align: right;">←</td></tr> <tr><td>14:</td><td>*10.6</td><td style="text-align: right;">↑</td></tr> <tr><td>15:</td><td>*10.5</td><td style="text-align: right;">↑</td></tr> <tr><td>16:</td><td>10.4</td><td style="text-align: right;">↗</td></tr> <tr><td>17:</td><td>10.4</td><td style="text-align: right;">↙</td></tr> <tr><td>18:</td><td>*10.5</td><td style="text-align: right;">↘</td></tr> <tr><td>19:</td><td>*10.6</td><td style="text-align: right;">↙</td></tr> <tr><td>20:</td><td>10.3</td><td style="text-align: right;">↙</td></tr> </table> <table border="1" style="width:100%; border-collapse: collapse; margin-top: 5px;"> <tr> <td style="width:80%;">Serie</td> <td style="text-align: right;">100.0</td> </tr> <tr> <td>Total</td> <td style="text-align: right;">200.0</td> </tr> </table> | 11: | *10.6 | ↙ | 12: | 10.4 | ↙ | 13: | *10.5 | ← | 14: | *10.6 | ↑ | 15: | *10.5 | ↑ | 16: | 10.4 | ↗ | 17: | 10.4 | ↙ | 18: | *10.5 | ↘ | 19: | *10.6 | ↙ | 20: | 10.3 | ↙ | Serie | 100.0 | Total | 200.0 |
| 11: | *10.6 | ↙ | | | | | | | | | | | | | | | | | | | | | | | | | | | | | | | | | |
| 12: | 10.4 | ↙ | | | | | | | | | | | | | | | | | | | | | | | | | | | | | | | | | |
| 13: | *10.5 | ← | | | | | | | | | | | | | | | | | | | | | | | | | | | | | | | | | |
| 14: | *10.6 | ↑ | | | | | | | | | | | | | | | | | | | | | | | | | | | | | | | | | |
| 15: | *10.5 | ↑ | | | | | | | | | | | | | | | | | | | | | | | | | | | | | | | | | |
| 16: | 10.4 | ↗ | | | | | | | | | | | | | | | | | | | | | | | | | | | | | | | | | |
| 17: | 10.4 | ↙ | | | | | | | | | | | | | | | | | | | | | | | | | | | | | | | | | |
| 18: | *10.5 | ↘ | | | | | | | | | | | | | | | | | | | | | | | | | | | | | | | | | |
| 19: | *10.6 | ↙ | | | | | | | | | | | | | | | | | | | | | | | | | | | | | | | | | |
| 20: | 10.3 | ↙ | | | | | | | | | | | | | | | | | | | | | | | | | | | | | | | | | |
| Serie | 100.0 | | | | | | | | | | | | | | | | | | | | | | | | | | | | | | | | | | |
| Total | 200.0 | | | | | | | | | | | | | | | | | | | | | | | | | | | | | | | | | | |

| | | | | | | | | | | | | | | | | | | | |
|---|--|-------|------|-------|-----|-----|---|----|-----|---|----|-------|---|----|-----|---|----|------|---|
| <p>Prøve</p> | <table style="width:100%; border-collapse: collapse;"> <tr><td style="width:10%;">1:</td><td style="width:15%;">10.5</td><td style="width:10%; text-align: center;">→</td></tr> <tr><td>2:</td><td>9.9</td><td style="text-align: center;">↑</td></tr> <tr><td>3:</td><td>9.7</td><td style="text-align: center;">←</td></tr> <tr><td>4:</td><td>*10.7</td><td style="text-align: center;">↗</td></tr> <tr><td>5:</td><td>9.7</td><td style="text-align: center;">↗</td></tr> <tr><td>6:</td><td>10.4</td><td style="text-align: center;">↑</td></tr> </table> | 1: | 10.5 | → | 2: | 9.9 | ↑ | 3: | 9.7 | ← | 4: | *10.7 | ↗ | 5: | 9.7 | ↗ | 6: | 10.4 | ↑ |
| 1: | 10.5 | → | | | | | | | | | | | | | | | | | |
| 2: | 9.9 | ↑ | | | | | | | | | | | | | | | | | |
| 3: | 9.7 | ← | | | | | | | | | | | | | | | | | |
| 4: | *10.7 | ↗ | | | | | | | | | | | | | | | | | |
| 5: | 9.7 | ↗ | | | | | | | | | | | | | | | | | |
| 6: | 10.4 | ↑ | | | | | | | | | | | | | | | | | |
| <table style="width:100%; border-collapse: collapse;"> <tr> <td style="width:90%;">Serie</td> <td style="text-align: right;">57.0</td> </tr> <tr> <td>Total</td> <td style="text-align: right;">0.0</td> </tr> </table> | | Serie | 57.0 | Total | 0.0 | | | | | | | | | | | | | | |
| Serie | 57.0 | | | | | | | | | | | | | | | | | | |
| Total | 0.0 | | | | | | | | | | | | | | | | | | |

| | | | | | | | | | | | | | | | | | | | | | | | | | | | | | | | |
|--|--|-------|------|-------|------|------|---|----|------|---|----|------|---|----|-------|---|----|-----|---|----|-----|---|----|------|---|----|------|---|-----|------|---|
| <p>20 Skud</p> | <table style="width:100%; border-collapse: collapse;"> <tr><td style="width:10%;">1:</td><td style="width:15%;">10.2</td><td style="width:10%; text-align: center;">↖</td></tr> <tr><td>2:</td><td>10.1</td><td style="text-align: center;">↑</td></tr> <tr><td>3:</td><td>10.2</td><td style="text-align: center;">↗</td></tr> <tr><td>4:</td><td>10.3</td><td style="text-align: center;">↓</td></tr> <tr><td>5:</td><td>*10.7</td><td style="text-align: center;">→</td></tr> <tr><td>6:</td><td>9.9</td><td style="text-align: center;">→</td></tr> <tr><td>7:</td><td>9.9</td><td style="text-align: center;">↗</td></tr> <tr><td>8:</td><td>10.4</td><td style="text-align: center;">↗</td></tr> <tr><td>9:</td><td>10.0</td><td style="text-align: center;">↑</td></tr> <tr><td>10:</td><td>10.0</td><td style="text-align: center;">→</td></tr> </table> | 1: | 10.2 | ↖ | 2: | 10.1 | ↑ | 3: | 10.2 | ↗ | 4: | 10.3 | ↓ | 5: | *10.7 | → | 6: | 9.9 | → | 7: | 9.9 | ↗ | 8: | 10.4 | ↗ | 9: | 10.0 | ↑ | 10: | 10.0 | → |
| 1: | 10.2 | ↖ | | | | | | | | | | | | | | | | | | | | | | | | | | | | | |
| 2: | 10.1 | ↑ | | | | | | | | | | | | | | | | | | | | | | | | | | | | | |
| 3: | 10.2 | ↗ | | | | | | | | | | | | | | | | | | | | | | | | | | | | | |
| 4: | 10.3 | ↓ | | | | | | | | | | | | | | | | | | | | | | | | | | | | | |
| 5: | *10.7 | → | | | | | | | | | | | | | | | | | | | | | | | | | | | | | |
| 6: | 9.9 | → | | | | | | | | | | | | | | | | | | | | | | | | | | | | | |
| 7: | 9.9 | ↗ | | | | | | | | | | | | | | | | | | | | | | | | | | | | | |
| 8: | 10.4 | ↗ | | | | | | | | | | | | | | | | | | | | | | | | | | | | | |
| 9: | 10.0 | ↑ | | | | | | | | | | | | | | | | | | | | | | | | | | | | | |
| 10: | 10.0 | → | | | | | | | | | | | | | | | | | | | | | | | | | | | | | |
| <table style="width:100%; border-collapse: collapse;"> <tr> <td style="width:90%;">Serie</td> <td style="text-align: right;">98.0</td> </tr> <tr> <td>Total</td> <td style="text-align: right;">98.0</td> </tr> </table> | | Serie | 98.0 | Total | 98.0 | | | | | | | | | | | | | | | | | | | | | | | | | | |
| Serie | 98.0 | | | | | | | | | | | | | | | | | | | | | | | | | | | | | | |
| Total | 98.0 | | | | | | | | | | | | | | | | | | | | | | | | | | | | | | |

| | | | | | | | | | | | | | | | | | | | | | | | | | | | | | | | |
|---|---|-------|------|-------|-------|-------|---|-----|-----|---|-----|------|---|-----|-------|---|-----|-------|---|-----|------|---|-----|------|---|-----|------|---|-----|-------|---|
| <p>20 Skud</p> | <table style="width:100%; border-collapse: collapse;"> <tr><td style="width:10%;">11:</td><td style="width:15%;">10.4</td><td style="width:10%; text-align: center;">↖</td></tr> <tr><td>12:</td><td>*10.7</td><td style="text-align: center;">→</td></tr> <tr><td>13:</td><td>9.7</td><td style="text-align: center;">↗</td></tr> <tr><td>14:</td><td>10.0</td><td style="text-align: center;">↖</td></tr> <tr><td>15:</td><td>*10.5</td><td style="text-align: center;">↖</td></tr> <tr><td>16:</td><td>*10.6</td><td style="text-align: center;">↑</td></tr> <tr><td>17:</td><td>10.5</td><td style="text-align: center;">↗</td></tr> <tr><td>18:</td><td>10.4</td><td style="text-align: center;">↑</td></tr> <tr><td>19:</td><td>10.4</td><td style="text-align: center;">←</td></tr> <tr><td>20:</td><td>*10.6</td><td style="text-align: center;">←</td></tr> </table> | 11: | 10.4 | ↖ | 12: | *10.7 | → | 13: | 9.7 | ↗ | 14: | 10.0 | ↖ | 15: | *10.5 | ↖ | 16: | *10.6 | ↑ | 17: | 10.5 | ↗ | 18: | 10.4 | ↑ | 19: | 10.4 | ← | 20: | *10.6 | ← |
| 11: | 10.4 | ↖ | | | | | | | | | | | | | | | | | | | | | | | | | | | | | |
| 12: | *10.7 | → | | | | | | | | | | | | | | | | | | | | | | | | | | | | | |
| 13: | 9.7 | ↗ | | | | | | | | | | | | | | | | | | | | | | | | | | | | | |
| 14: | 10.0 | ↖ | | | | | | | | | | | | | | | | | | | | | | | | | | | | | |
| 15: | *10.5 | ↖ | | | | | | | | | | | | | | | | | | | | | | | | | | | | | |
| 16: | *10.6 | ↑ | | | | | | | | | | | | | | | | | | | | | | | | | | | | | |
| 17: | 10.5 | ↗ | | | | | | | | | | | | | | | | | | | | | | | | | | | | | |
| 18: | 10.4 | ↑ | | | | | | | | | | | | | | | | | | | | | | | | | | | | | |
| 19: | 10.4 | ← | | | | | | | | | | | | | | | | | | | | | | | | | | | | | |
| 20: | *10.6 | ← | | | | | | | | | | | | | | | | | | | | | | | | | | | | | |
| <table style="width:100%; border-collapse: collapse;"> <tr> <td style="width:90%;">Serie</td> <td style="text-align: right;">99.0</td> </tr> <tr> <td>Total</td> <td style="text-align: right;">197.0</td> </tr> </table> | | Serie | 99.0 | Total | 197.0 | | | | | | | | | | | | | | | | | | | | | | | | | | |
| Serie | 99.0 | | | | | | | | | | | | | | | | | | | | | | | | | | | | | | |
| Total | 197.0 | | | | | | | | | | | | | | | | | | | | | | | | | | | | | | |

| | | | | | | | | | | | | | | | | | | | | | | | | | |
|---|--|-------|-----|------|-------|------|-----|----|-------|---|----|-------|---|----|-------|---|----|-------|---|----|------|---|----|-------|---|
| <p>Prøve</p> | <table style="width:100%; border-collapse: collapse;"> <tr><td style="width:10%;">1:</td><td style="width:10%;">9.7</td><td style="width:10%; text-align: center;">↖</td></tr> <tr><td>2:</td><td>10.0</td><td style="text-align: center;">→</td></tr> <tr><td>3:</td><td>*10.6</td><td style="text-align: center;">↙</td></tr> <tr><td>4:</td><td>*10.9</td><td style="text-align: center;">↑</td></tr> <tr><td>5:</td><td>*10.5</td><td style="text-align: center;">↖</td></tr> <tr><td>6:</td><td>*10.6</td><td style="text-align: center;">↗</td></tr> <tr><td>7:</td><td>10.1</td><td style="text-align: center;">→</td></tr> <tr><td>8:</td><td>*10.8</td><td style="text-align: center;">↘</td></tr> </table> | 1: | 9.7 | ↖ | 2: | 10.0 | → | 3: | *10.6 | ↙ | 4: | *10.9 | ↑ | 5: | *10.5 | ↖ | 6: | *10.6 | ↗ | 7: | 10.1 | → | 8: | *10.8 | ↘ |
| 1: | 9.7 | ↖ | | | | | | | | | | | | | | | | | | | | | | | |
| 2: | 10.0 | → | | | | | | | | | | | | | | | | | | | | | | | |
| 3: | *10.6 | ↙ | | | | | | | | | | | | | | | | | | | | | | | |
| 4: | *10.9 | ↑ | | | | | | | | | | | | | | | | | | | | | | | |
| 5: | *10.5 | ↖ | | | | | | | | | | | | | | | | | | | | | | | |
| 6: | *10.6 | ↗ | | | | | | | | | | | | | | | | | | | | | | | |
| 7: | 10.1 | → | | | | | | | | | | | | | | | | | | | | | | | |
| 8: | *10.8 | ↘ | | | | | | | | | | | | | | | | | | | | | | | |
| <table style="width:100%; border-collapse: collapse;"> <tr> <td style="width:10%; text-align: left;">Serie</td> <td style="width:80%;"></td> <td style="width:10%; text-align: right;">79.0</td> </tr> <tr> <td style="text-align: left;">Total</td> <td></td> <td style="text-align: right;">0.0</td> </tr> </table> | | Serie | | 79.0 | Total | | 0.0 | | | | | | | | | | | | | | | | | | |
| Serie | | 79.0 | | | | | | | | | | | | | | | | | | | | | | | |
| Total | | 0.0 | | | | | | | | | | | | | | | | | | | | | | | |

| | | | | | | | | | | | | | | | | | | | | | | | | | | | | | | | |
|--|--|-------|-------|-------|-------|-------|-------|----|-------|---|----|-------|---|----|-------|---|----|-------|---|----|------|---|----|-------|---|----|-------|---|-----|-------|---|
| <p>20 Skud</p> | <table style="width:100%; border-collapse: collapse;"> <tr><td style="width:10%;">1:</td><td style="width:10%;">*10.6</td><td style="width:10%; text-align: center;">↓</td></tr> <tr><td>2:</td><td>*10.7</td><td style="text-align: center;">→</td></tr> <tr><td>3:</td><td>*10.7</td><td style="text-align: center;">↙</td></tr> <tr><td>4:</td><td>*10.6</td><td style="text-align: center;">↘</td></tr> <tr><td>5:</td><td>*10.9</td><td style="text-align: center;">→</td></tr> <tr><td>6:</td><td>*10.7</td><td style="text-align: center;">↙</td></tr> <tr><td>7:</td><td>10.1</td><td style="text-align: center;">↓</td></tr> <tr><td>8:</td><td>*10.8</td><td style="text-align: center;">↖</td></tr> <tr><td>9:</td><td>*10.7</td><td style="text-align: center;">↓</td></tr> <tr><td>10:</td><td>*10.6</td><td style="text-align: center;">↗</td></tr> </table> | 1: | *10.6 | ↓ | 2: | *10.7 | → | 3: | *10.7 | ↙ | 4: | *10.6 | ↘ | 5: | *10.9 | → | 6: | *10.7 | ↙ | 7: | 10.1 | ↓ | 8: | *10.8 | ↖ | 9: | *10.7 | ↓ | 10: | *10.6 | ↗ |
| 1: | *10.6 | ↓ | | | | | | | | | | | | | | | | | | | | | | | | | | | | | |
| 2: | *10.7 | → | | | | | | | | | | | | | | | | | | | | | | | | | | | | | |
| 3: | *10.7 | ↙ | | | | | | | | | | | | | | | | | | | | | | | | | | | | | |
| 4: | *10.6 | ↘ | | | | | | | | | | | | | | | | | | | | | | | | | | | | | |
| 5: | *10.9 | → | | | | | | | | | | | | | | | | | | | | | | | | | | | | | |
| 6: | *10.7 | ↙ | | | | | | | | | | | | | | | | | | | | | | | | | | | | | |
| 7: | 10.1 | ↓ | | | | | | | | | | | | | | | | | | | | | | | | | | | | | |
| 8: | *10.8 | ↖ | | | | | | | | | | | | | | | | | | | | | | | | | | | | | |
| 9: | *10.7 | ↓ | | | | | | | | | | | | | | | | | | | | | | | | | | | | | |
| 10: | *10.6 | ↗ | | | | | | | | | | | | | | | | | | | | | | | | | | | | | |
| <table style="width:100%; border-collapse: collapse;"> <tr> <td style="width:10%; text-align: left;">Serie</td> <td style="width:80%;"></td> <td style="width:10%; text-align: right;">100.0</td> </tr> <tr> <td style="text-align: left;">Total</td> <td></td> <td style="text-align: right;">100.0</td> </tr> </table> | | Serie | | 100.0 | Total | | 100.0 | | | | | | | | | | | | | | | | | | | | | | | | |
| Serie | | 100.0 | | | | | | | | | | | | | | | | | | | | | | | | | | | | | |
| Total | | 100.0 | | | | | | | | | | | | | | | | | | | | | | | | | | | | | |

| | | | | | | | | | | | | | | | | | | | | | | | | | | | | | | | |
|--|---|-------|-------|-------|-------|------|-------|-----|------|---|-----|------|---|-----|-------|---|-----|-------|---|-----|------|---|-----|-------|---|-----|------|---|-----|-------|---|
| <p>20 Skud</p> | <table style="width:100%; border-collapse: collapse;"> <tr><td style="width:10%;">11:</td><td style="width:10%;">*10.7</td><td style="width:10%; text-align: center;">→</td></tr> <tr><td>12:</td><td>10.1</td><td style="text-align: center;">→</td></tr> <tr><td>13:</td><td>10.3</td><td style="text-align: center;">↙</td></tr> <tr><td>14:</td><td>10.0</td><td style="text-align: center;">→</td></tr> <tr><td>15:</td><td>*10.8</td><td style="text-align: center;">↖</td></tr> <tr><td>16:</td><td>*10.7</td><td style="text-align: center;">↙</td></tr> <tr><td>17:</td><td>10.4</td><td style="text-align: center;">↘</td></tr> <tr><td>18:</td><td>*10.8</td><td style="text-align: center;">↖</td></tr> <tr><td>19:</td><td>10.0</td><td style="text-align: center;">↓</td></tr> <tr><td>20:</td><td>*10.7</td><td style="text-align: center;">↑</td></tr> </table> | 11: | *10.7 | → | 12: | 10.1 | → | 13: | 10.3 | ↙ | 14: | 10.0 | → | 15: | *10.8 | ↖ | 16: | *10.7 | ↙ | 17: | 10.4 | ↘ | 18: | *10.8 | ↖ | 19: | 10.0 | ↓ | 20: | *10.7 | ↑ |
| 11: | *10.7 | → | | | | | | | | | | | | | | | | | | | | | | | | | | | | | |
| 12: | 10.1 | → | | | | | | | | | | | | | | | | | | | | | | | | | | | | | |
| 13: | 10.3 | ↙ | | | | | | | | | | | | | | | | | | | | | | | | | | | | | |
| 14: | 10.0 | → | | | | | | | | | | | | | | | | | | | | | | | | | | | | | |
| 15: | *10.8 | ↖ | | | | | | | | | | | | | | | | | | | | | | | | | | | | | |
| 16: | *10.7 | ↙ | | | | | | | | | | | | | | | | | | | | | | | | | | | | | |
| 17: | 10.4 | ↘ | | | | | | | | | | | | | | | | | | | | | | | | | | | | | |
| 18: | *10.8 | ↖ | | | | | | | | | | | | | | | | | | | | | | | | | | | | | |
| 19: | 10.0 | ↓ | | | | | | | | | | | | | | | | | | | | | | | | | | | | | |
| 20: | *10.7 | ↑ | | | | | | | | | | | | | | | | | | | | | | | | | | | | | |
| <table style="width:100%; border-collapse: collapse;"> <tr> <td style="width:10%; text-align: left;">Serie</td> <td style="width:80%;"></td> <td style="width:10%; text-align: right;">100.0</td> </tr> <tr> <td style="text-align: left;">Total</td> <td></td> <td style="text-align: right;">200.0</td> </tr> </table> | | Serie | | 100.0 | Total | | 200.0 | | | | | | | | | | | | | | | | | | | | | | | | |
| Serie | | 100.0 | | | | | | | | | | | | | | | | | | | | | | | | | | | | | |
| Total | | 200.0 | | | | | | | | | | | | | | | | | | | | | | | | | | | | | |

Hold
25

Skive
6

Anders Riisgaard

Vilsted Skf.

MB2

Prøve

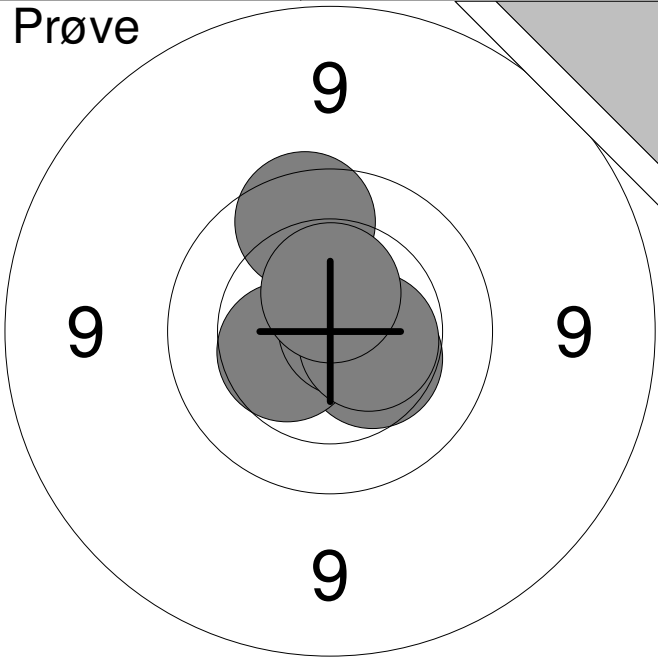

| | | |
|----|-------|---|
| 1: | 10.4 | ↘ |
| 2: | 9.8 | ↑ |
| 3: | 10.4 | ↙ |
| 4: | *10.7 | → |
| 5: | *10.5 | → |
| 6: | *10.5 | ↑ |

| | |
|-------|------|
| Serie | 59.0 |
| Total | 0.0 |

20 Skud

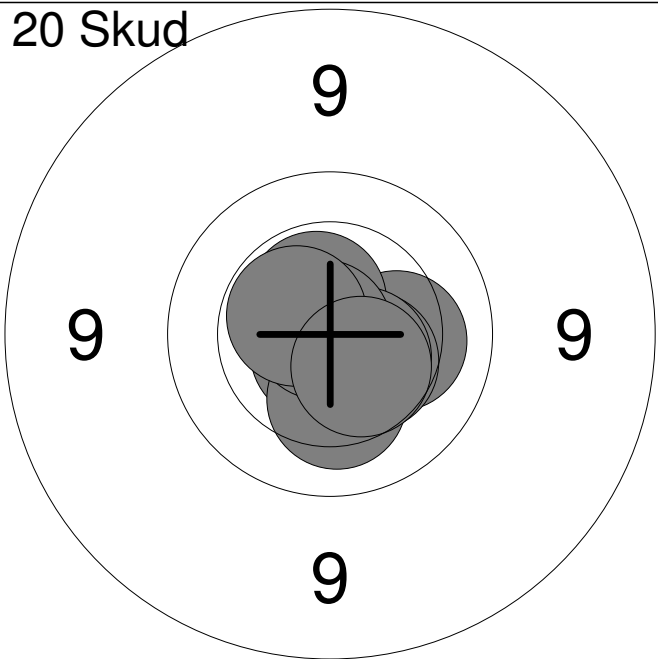

| | | |
|-----|-------|---|
| 1: | *10.7 | ↙ |
| 2: | 10.2 | → |
| 3: | *10.7 | ↗ |
| 4: | *10.6 | ↗ |
| 5: | 10.4 | ↘ |
| 6: | *10.5 | ↘ |
| 7: | 10.2 | ↘ |
| 8: | *10.9 | ↗ |
| 9: | *10.5 | ↗ |
| 10: | 10.5 | ↘ |

| | |
|-------|-------|
| Serie | 100.0 |
| Total | 100.0 |

20 Skud

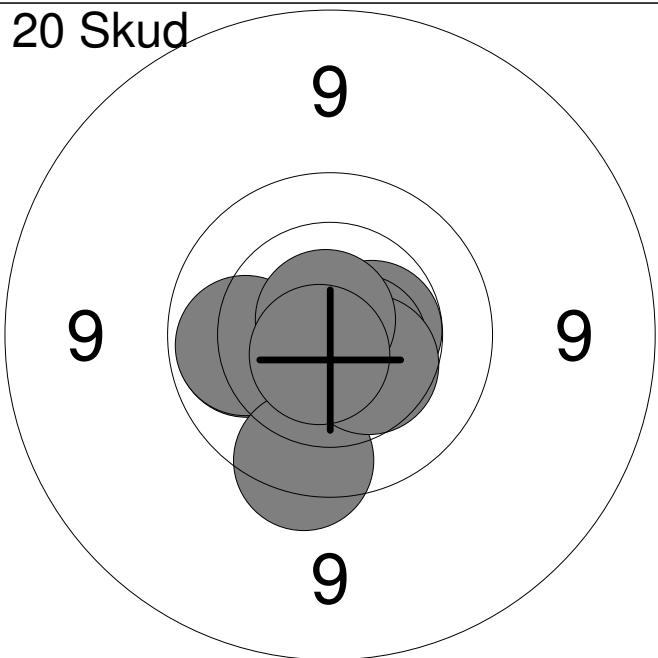

| | | |
|-----|-------|---|
| 11: | 10.0 | ↙ |
| 12: | *10.5 | ↓ |
| 13: | 10.0 | ↙ |
| 14: | *10.5 | → |
| 15: | *10.6 | → |
| 16: | *10.6 | ↓ |
| 17: | 9.7 | ↓ |
| 18: | 10.4 | ↘ |
| 19: | *10.8 | ↗ |
| 20: | *10.7 | ↙ |

| | |
|-------|-------|
| Serie | 99.0 |
| Total | 199.0 |

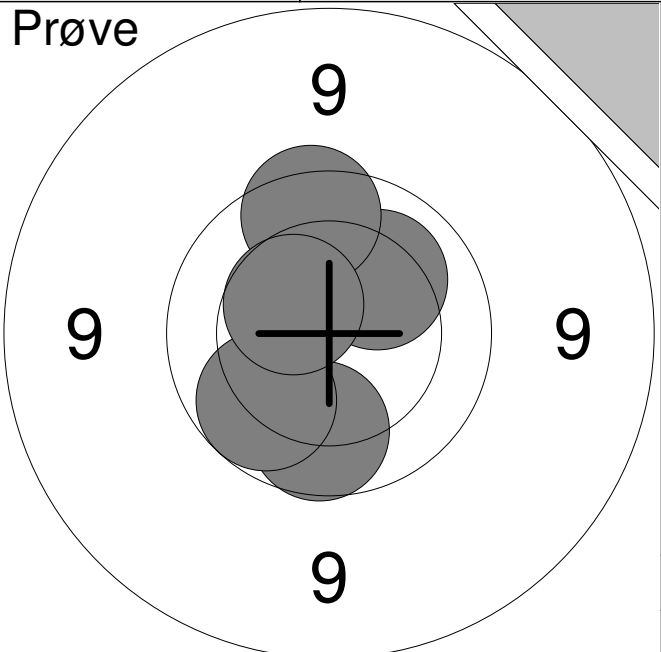
| | | | | | | | | | | | | | | | | |
|--|--|-------|------|-------|-----|------|---|----|------|---|----|-----|---|----|------|---|
| <p>Prøve</p>  | <table style="width:100%; border-collapse: collapse;"> <tr><td style="width:10%;">1:</td><td style="width:30%;">9.9</td><td style="width:10%; text-align: center;">↓</td></tr> <tr><td>2:</td><td>10.0</td><td style="text-align: center;">↙</td></tr> <tr><td>3:</td><td>10.2</td><td style="text-align: center;">↗</td></tr> <tr><td>4:</td><td>9.8</td><td style="text-align: center;">↑</td></tr> <tr><td>5:</td><td>10.5</td><td style="text-align: center;">↗</td></tr> </table> | 1: | 9.9 | ↓ | 2: | 10.0 | ↙ | 3: | 10.2 | ↗ | 4: | 9.8 | ↑ | 5: | 10.5 | ↗ |
| 1: | 9.9 | ↓ | | | | | | | | | | | | | | |
| 2: | 10.0 | ↙ | | | | | | | | | | | | | | |
| 3: | 10.2 | ↗ | | | | | | | | | | | | | | |
| 4: | 9.8 | ↑ | | | | | | | | | | | | | | |
| 5: | 10.5 | ↗ | | | | | | | | | | | | | | |
| <table style="width:100%; border-collapse: collapse;"> <tr> <td style="width:45%;">Serie</td> <td style="width:55%; text-align: right;">48.0</td> </tr> <tr> <td>Total</td> <td style="text-align: right;">0.0</td> </tr> </table> | | Serie | 48.0 | Total | 0.0 | | | | | | | | | | | |
| Serie | 48.0 | | | | | | | | | | | | | | | |
| Total | 0.0 | | | | | | | | | | | | | | | |

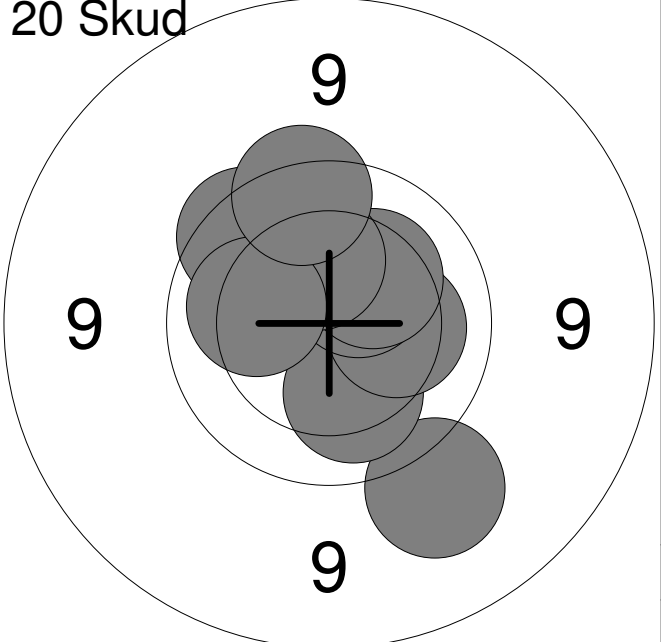
| | | | | | | | | | | | | | | | | | | | | | | | | | | | | | | | |
|---|---|-------|-------|-------|------|-----|---|----|------|---|----|------|---|----|------|---|----|------|---|----|------|---|----|-----|---|----|------|---|-----|-----|---|
| <p>20 Skud</p>  | <table style="width:100%; border-collapse: collapse;"> <tr><td style="width:10%;">1:</td><td style="width:30%;">*10.6</td><td style="width:10%; text-align: center;">→</td></tr> <tr><td>2:</td><td>9.3</td><td style="text-align: center;">↓</td></tr> <tr><td>3:</td><td>10.2</td><td style="text-align: center;">↓</td></tr> <tr><td>4:</td><td>10.2</td><td style="text-align: center;">→</td></tr> <tr><td>5:</td><td>10.4</td><td style="text-align: center;">↗</td></tr> <tr><td>6:</td><td>10.3</td><td style="text-align: center;">↗</td></tr> <tr><td>7:</td><td>10.3</td><td style="text-align: center;">↑</td></tr> <tr><td>8:</td><td>9.8</td><td style="text-align: center;">↗</td></tr> <tr><td>9:</td><td>10.1</td><td style="text-align: center;">←</td></tr> <tr><td>10:</td><td>9.7</td><td style="text-align: center;">↑</td></tr> </table> | 1: | *10.6 | → | 2: | 9.3 | ↓ | 3: | 10.2 | ↓ | 4: | 10.2 | → | 5: | 10.4 | ↗ | 6: | 10.3 | ↗ | 7: | 10.3 | ↑ | 8: | 9.8 | ↗ | 9: | 10.1 | ← | 10: | 9.7 | ↑ |
| 1: | *10.6 | → | | | | | | | | | | | | | | | | | | | | | | | | | | | | | |
| 2: | 9.3 | ↓ | | | | | | | | | | | | | | | | | | | | | | | | | | | | | |
| 3: | 10.2 | ↓ | | | | | | | | | | | | | | | | | | | | | | | | | | | | | |
| 4: | 10.2 | → | | | | | | | | | | | | | | | | | | | | | | | | | | | | | |
| 5: | 10.4 | ↗ | | | | | | | | | | | | | | | | | | | | | | | | | | | | | |
| 6: | 10.3 | ↗ | | | | | | | | | | | | | | | | | | | | | | | | | | | | | |
| 7: | 10.3 | ↑ | | | | | | | | | | | | | | | | | | | | | | | | | | | | | |
| 8: | 9.8 | ↗ | | | | | | | | | | | | | | | | | | | | | | | | | | | | | |
| 9: | 10.1 | ← | | | | | | | | | | | | | | | | | | | | | | | | | | | | | |
| 10: | 9.7 | ↑ | | | | | | | | | | | | | | | | | | | | | | | | | | | | | |
| <table style="width:100%; border-collapse: collapse;"> <tr> <td style="width:45%;">Serie</td> <td style="width:55%; text-align: right;">97.0</td> </tr> <tr> <td>Total</td> <td style="text-align: right;">97.0</td> </tr> </table> | | Serie | 97.0 | Total | 97.0 | | | | | | | | | | | | | | | | | | | | | | | | | | |
| Serie | 97.0 | | | | | | | | | | | | | | | | | | | | | | | | | | | | | | |
| Total | 97.0 | | | | | | | | | | | | | | | | | | | | | | | | | | | | | | |

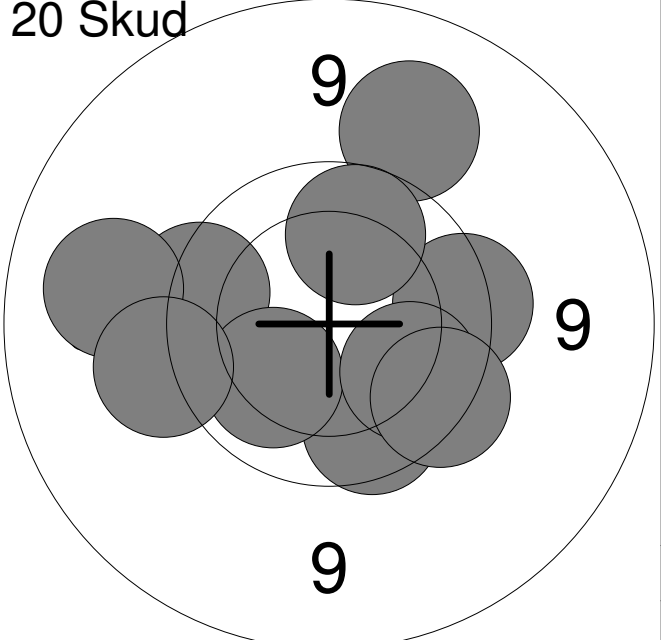
| | | | | | | | | | | | | | | | | | | | | | | | | | | | | | | | |
|--|---|-------|------|-------|-------|-----|---|-----|------|---|-----|-----|---|-----|-----|---|-----|-----|---|-----|-----|---|-----|-----|---|-----|-----|---|-----|-----|---|
| <p>20 Skud</p>  | <table style="width:100%; border-collapse: collapse;"> <tr><td style="width:10%;">11:</td><td style="width:30%;">9.8</td><td style="width:10%; text-align: center;">↓</td></tr> <tr><td>12:</td><td>9.7</td><td style="text-align: center;">←</td></tr> <tr><td>13:</td><td>10.1</td><td style="text-align: center;">↙</td></tr> <tr><td>14:</td><td>9.2</td><td style="text-align: center;">←</td></tr> <tr><td>15:</td><td>9.5</td><td style="text-align: center;">←</td></tr> <tr><td>16:</td><td>9.7</td><td style="text-align: center;">→</td></tr> <tr><td>17:</td><td>9.9</td><td style="text-align: center;">↘</td></tr> <tr><td>18:</td><td>9.2</td><td style="text-align: center;">↗</td></tr> <tr><td>19:</td><td>9.7</td><td style="text-align: center;">↘</td></tr> <tr><td>20:</td><td>9.9</td><td style="text-align: center;">↑</td></tr> </table> | 11: | 9.8 | ↓ | 12: | 9.7 | ← | 13: | 10.1 | ↙ | 14: | 9.2 | ← | 15: | 9.5 | ← | 16: | 9.7 | → | 17: | 9.9 | ↘ | 18: | 9.2 | ↗ | 19: | 9.7 | ↘ | 20: | 9.9 | ↑ |
| 11: | 9.8 | ↓ | | | | | | | | | | | | | | | | | | | | | | | | | | | | | |
| 12: | 9.7 | ← | | | | | | | | | | | | | | | | | | | | | | | | | | | | | |
| 13: | 10.1 | ↙ | | | | | | | | | | | | | | | | | | | | | | | | | | | | | |
| 14: | 9.2 | ← | | | | | | | | | | | | | | | | | | | | | | | | | | | | | |
| 15: | 9.5 | ← | | | | | | | | | | | | | | | | | | | | | | | | | | | | | |
| 16: | 9.7 | → | | | | | | | | | | | | | | | | | | | | | | | | | | | | | |
| 17: | 9.9 | ↘ | | | | | | | | | | | | | | | | | | | | | | | | | | | | | |
| 18: | 9.2 | ↗ | | | | | | | | | | | | | | | | | | | | | | | | | | | | | |
| 19: | 9.7 | ↘ | | | | | | | | | | | | | | | | | | | | | | | | | | | | | |
| 20: | 9.9 | ↑ | | | | | | | | | | | | | | | | | | | | | | | | | | | | | |
| <table style="width:100%; border-collapse: collapse;"> <tr> <td style="width:45%;">Serie</td> <td style="width:55%; text-align: right;">91.0</td> </tr> <tr> <td>Total</td> <td style="text-align: right;">188.0</td> </tr> </table> | | Serie | 91.0 | Total | 188.0 | | | | | | | | | | | | | | | | | | | | | | | | | | |
| Serie | 91.0 | | | | | | | | | | | | | | | | | | | | | | | | | | | | | | |
| Total | 188.0 | | | | | | | | | | | | | | | | | | | | | | | | | | | | | | |

| | | | | | | | | | | | | | | | | | | | | |
|---------------------|--|----|------|---|----|-------|---|----|-----|---|----|------|---|----|-------|---|-------|------|-------|-----|
| <p>Prøve</p> | <table style="width:100%; border-collapse: collapse;"> <tr><td style="width:10%;">1:</td><td style="width:15%;">10.0</td><td style="width:10%; text-align: right;">→</td></tr> <tr><td>2:</td><td>*10.8</td><td style="text-align: right;">←</td></tr> <tr><td>3:</td><td>9.7</td><td style="text-align: right;">→</td></tr> <tr><td>4:</td><td>10.4</td><td style="text-align: right;">←</td></tr> <tr><td>5:</td><td>*10.5</td><td style="text-align: right;">←</td></tr> </table> <table border="1" style="width:100%; border-collapse: collapse; margin-top: 5px;"> <tr> <td style="width:80%;">Serie</td> <td style="text-align: right;">49.0</td> </tr> <tr> <td>Total</td> <td style="text-align: right;">0.0</td> </tr> </table> | 1: | 10.0 | → | 2: | *10.8 | ← | 3: | 9.7 | → | 4: | 10.4 | ← | 5: | *10.5 | ← | Serie | 49.0 | Total | 0.0 |
| 1: | 10.0 | → | | | | | | | | | | | | | | | | | | |
| 2: | *10.8 | ← | | | | | | | | | | | | | | | | | | |
| 3: | 9.7 | → | | | | | | | | | | | | | | | | | | |
| 4: | 10.4 | ← | | | | | | | | | | | | | | | | | | |
| 5: | *10.5 | ← | | | | | | | | | | | | | | | | | | |
| Serie | 49.0 | | | | | | | | | | | | | | | | | | | |
| Total | 0.0 | | | | | | | | | | | | | | | | | | | |

| | | | | | | | | | | | | | | | | | | | | | | | | | | | | | | | | | | | |
|-----------------------|---|----|-----|---|----|------|---|----|------|---|----|------|---|----|-----|---|----|-----|---|----|-----|---|----|------|---|----|-----|---|-----|------|---|-------|------|-------|------|
| <p>20 Skud</p> | <table style="width:100%; border-collapse: collapse;"> <tr><td style="width:10%;">1:</td><td style="width:15%;">9.6</td><td style="width:10%; text-align: right;">→</td></tr> <tr><td>2:</td><td>10.3</td><td style="text-align: right;">←</td></tr> <tr><td>3:</td><td>10.0</td><td style="text-align: right;">←</td></tr> <tr><td>4:</td><td>10.4</td><td style="text-align: right;">↗</td></tr> <tr><td>5:</td><td>9.7</td><td style="text-align: right;">↗</td></tr> <tr><td>6:</td><td>9.6</td><td style="text-align: right;">↗</td></tr> <tr><td>7:</td><td>9.6</td><td style="text-align: right;">↗</td></tr> <tr><td>8:</td><td>10.5</td><td style="text-align: right;">↗</td></tr> <tr><td>9:</td><td>9.6</td><td style="text-align: right;">→</td></tr> <tr><td>10:</td><td>10.3</td><td style="text-align: right;">↗</td></tr> </table> <table border="1" style="width:100%; border-collapse: collapse; margin-top: 5px;"> <tr> <td style="width:80%;">Serie</td> <td style="text-align: right;">95.0</td> </tr> <tr> <td>Total</td> <td style="text-align: right;">95.0</td> </tr> </table> | 1: | 9.6 | → | 2: | 10.3 | ← | 3: | 10.0 | ← | 4: | 10.4 | ↗ | 5: | 9.7 | ↗ | 6: | 9.6 | ↗ | 7: | 9.6 | ↗ | 8: | 10.5 | ↗ | 9: | 9.6 | → | 10: | 10.3 | ↗ | Serie | 95.0 | Total | 95.0 |
| 1: | 9.6 | → | | | | | | | | | | | | | | | | | | | | | | | | | | | | | | | | | |
| 2: | 10.3 | ← | | | | | | | | | | | | | | | | | | | | | | | | | | | | | | | | | |
| 3: | 10.0 | ← | | | | | | | | | | | | | | | | | | | | | | | | | | | | | | | | | |
| 4: | 10.4 | ↗ | | | | | | | | | | | | | | | | | | | | | | | | | | | | | | | | | |
| 5: | 9.7 | ↗ | | | | | | | | | | | | | | | | | | | | | | | | | | | | | | | | | |
| 6: | 9.6 | ↗ | | | | | | | | | | | | | | | | | | | | | | | | | | | | | | | | | |
| 7: | 9.6 | ↗ | | | | | | | | | | | | | | | | | | | | | | | | | | | | | | | | | |
| 8: | 10.5 | ↗ | | | | | | | | | | | | | | | | | | | | | | | | | | | | | | | | | |
| 9: | 9.6 | → | | | | | | | | | | | | | | | | | | | | | | | | | | | | | | | | | |
| 10: | 10.3 | ↗ | | | | | | | | | | | | | | | | | | | | | | | | | | | | | | | | | |
| Serie | 95.0 | | | | | | | | | | | | | | | | | | | | | | | | | | | | | | | | | | |
| Total | 95.0 | | | | | | | | | | | | | | | | | | | | | | | | | | | | | | | | | | |

| | | | | | | | | | | | | | | | | | | | | | | | | | | | | | | | | | | | |
|-----------------------|---|-----|------|---|-----|------|---|-----|------|---|-----|-----|---|-----|-----|---|-----|------|---|-----|-----|---|-----|-------|---|-----|-----|---|-----|------|---|-------|------|-------|-------|
| <p>20 Skud</p> | <table style="width:100%; border-collapse: collapse;"> <tr><td style="width:10%;">11:</td><td style="width:15%;">10.0</td><td style="width:10%; text-align: right;">↗</td></tr> <tr><td>12:</td><td>10.3</td><td style="text-align: right;">↑</td></tr> <tr><td>13:</td><td>10.2</td><td style="text-align: right;">↘</td></tr> <tr><td>14:</td><td>9.8</td><td style="text-align: right;">↑</td></tr> <tr><td>15:</td><td>9.7</td><td style="text-align: right;">↗</td></tr> <tr><td>16:</td><td>10.0</td><td style="text-align: right;">←</td></tr> <tr><td>17:</td><td>9.8</td><td style="text-align: right;">→</td></tr> <tr><td>18:</td><td>*10.8</td><td style="text-align: right;">←</td></tr> <tr><td>19:</td><td>9.9</td><td style="text-align: right;">↗</td></tr> <tr><td>20:</td><td>10.3</td><td style="text-align: right;">→</td></tr> </table> <table border="1" style="width:100%; border-collapse: collapse; margin-top: 5px;"> <tr> <td style="width:80%;">Serie</td> <td style="text-align: right;">96.0</td> </tr> <tr> <td>Total</td> <td style="text-align: right;">191.0</td> </tr> </table> | 11: | 10.0 | ↗ | 12: | 10.3 | ↑ | 13: | 10.2 | ↘ | 14: | 9.8 | ↑ | 15: | 9.7 | ↗ | 16: | 10.0 | ← | 17: | 9.8 | → | 18: | *10.8 | ← | 19: | 9.9 | ↗ | 20: | 10.3 | → | Serie | 96.0 | Total | 191.0 |
| 11: | 10.0 | ↗ | | | | | | | | | | | | | | | | | | | | | | | | | | | | | | | | | |
| 12: | 10.3 | ↑ | | | | | | | | | | | | | | | | | | | | | | | | | | | | | | | | | |
| 13: | 10.2 | ↘ | | | | | | | | | | | | | | | | | | | | | | | | | | | | | | | | | |
| 14: | 9.8 | ↑ | | | | | | | | | | | | | | | | | | | | | | | | | | | | | | | | | |
| 15: | 9.7 | ↗ | | | | | | | | | | | | | | | | | | | | | | | | | | | | | | | | | |
| 16: | 10.0 | ← | | | | | | | | | | | | | | | | | | | | | | | | | | | | | | | | | |
| 17: | 9.8 | → | | | | | | | | | | | | | | | | | | | | | | | | | | | | | | | | | |
| 18: | *10.8 | ← | | | | | | | | | | | | | | | | | | | | | | | | | | | | | | | | | |
| 19: | 9.9 | ↗ | | | | | | | | | | | | | | | | | | | | | | | | | | | | | | | | | |
| 20: | 10.3 | → | | | | | | | | | | | | | | | | | | | | | | | | | | | | | | | | | |
| Serie | 96.0 | | | | | | | | | | | | | | | | | | | | | | | | | | | | | | | | | | |
| Total | 191.0 | | | | | | | | | | | | | | | | | | | | | | | | | | | | | | | | | | |

| | | | | | | | | | | | | | | | | | | | | | | | |
|---------------------|--|----|-------|---|----|-------|---|----|-------|---|----|------|---|----|------|---|----|-------|---|-------|------|-------|-----|
| <p>Prøve</p> | <table style="width:100%; border-collapse: collapse;"> <tr><td style="width:10%;">1:</td><td style="width:15%;">*10.7</td><td style="width:10%; text-align: right;">↘</td></tr> <tr><td>2:</td><td>*10.6</td><td style="text-align: right;">↗</td></tr> <tr><td>3:</td><td>*10.6</td><td style="text-align: right;">↘</td></tr> <tr><td>4:</td><td>10.5</td><td style="text-align: right;">↘</td></tr> <tr><td>5:</td><td>10.0</td><td style="text-align: right;">→</td></tr> <tr><td>6:</td><td>*10.6</td><td style="text-align: right;">↘</td></tr> </table> <table border="1" style="width:100%; border-collapse: collapse; margin-top: 5px;"> <tr> <td style="width:80%;">Serie</td> <td style="text-align: right;">60.0</td> </tr> <tr> <td>Total</td> <td style="text-align: right;">0.0</td> </tr> </table> | 1: | *10.7 | ↘ | 2: | *10.6 | ↗ | 3: | *10.6 | ↘ | 4: | 10.5 | ↘ | 5: | 10.0 | → | 6: | *10.6 | ↘ | Serie | 60.0 | Total | 0.0 |
| 1: | *10.7 | ↘ | | | | | | | | | | | | | | | | | | | | | |
| 2: | *10.6 | ↗ | | | | | | | | | | | | | | | | | | | | | |
| 3: | *10.6 | ↘ | | | | | | | | | | | | | | | | | | | | | |
| 4: | 10.5 | ↘ | | | | | | | | | | | | | | | | | | | | | |
| 5: | 10.0 | → | | | | | | | | | | | | | | | | | | | | | |
| 6: | *10.6 | ↘ | | | | | | | | | | | | | | | | | | | | | |
| Serie | 60.0 | | | | | | | | | | | | | | | | | | | | | | |
| Total | 0.0 | | | | | | | | | | | | | | | | | | | | | | |

| | | | | | | | | | | | | | | | | | | | | | | | | | | | | | | | | | | | |
|-----------------------|--|----|------|---|----|------|---|----|------|---|----|------|---|----|------|---|----|-------|---|----|------|---|----|------|---|----|------|---|-----|-------|---|-------|-------|-------|-------|
| <p>20 Skud</p> | <table style="width:100%; border-collapse: collapse;"> <tr><td style="width:10%;">1:</td><td style="width:15%;">10.4</td><td style="width:10%; text-align: right;">↗</td></tr> <tr><td>2:</td><td>10.4</td><td style="text-align: right;">↗</td></tr> <tr><td>3:</td><td>10.4</td><td style="text-align: right;">↘</td></tr> <tr><td>4:</td><td>10.4</td><td style="text-align: right;">↘</td></tr> <tr><td>5:</td><td>10.0</td><td style="text-align: right;">↘</td></tr> <tr><td>6:</td><td>*10.5</td><td style="text-align: right;">↘</td></tr> <tr><td>7:</td><td>10.3</td><td style="text-align: right;">↗</td></tr> <tr><td>8:</td><td>10.4</td><td style="text-align: right;">←</td></tr> <tr><td>9:</td><td>10.2</td><td style="text-align: right;">↗</td></tr> <tr><td>10:</td><td>*10.6</td><td style="text-align: right;">→</td></tr> </table> <table border="1" style="width:100%; border-collapse: collapse; margin-top: 5px;"> <tr> <td style="width:80%;">Serie</td> <td style="text-align: right;">100.0</td> </tr> <tr> <td>Total</td> <td style="text-align: right;">100.0</td> </tr> </table> | 1: | 10.4 | ↗ | 2: | 10.4 | ↗ | 3: | 10.4 | ↘ | 4: | 10.4 | ↘ | 5: | 10.0 | ↘ | 6: | *10.5 | ↘ | 7: | 10.3 | ↗ | 8: | 10.4 | ← | 9: | 10.2 | ↗ | 10: | *10.6 | → | Serie | 100.0 | Total | 100.0 |
| 1: | 10.4 | ↗ | | | | | | | | | | | | | | | | | | | | | | | | | | | | | | | | | |
| 2: | 10.4 | ↗ | | | | | | | | | | | | | | | | | | | | | | | | | | | | | | | | | |
| 3: | 10.4 | ↘ | | | | | | | | | | | | | | | | | | | | | | | | | | | | | | | | | |
| 4: | 10.4 | ↘ | | | | | | | | | | | | | | | | | | | | | | | | | | | | | | | | | |
| 5: | 10.0 | ↘ | | | | | | | | | | | | | | | | | | | | | | | | | | | | | | | | | |
| 6: | *10.5 | ↘ | | | | | | | | | | | | | | | | | | | | | | | | | | | | | | | | | |
| 7: | 10.3 | ↗ | | | | | | | | | | | | | | | | | | | | | | | | | | | | | | | | | |
| 8: | 10.4 | ← | | | | | | | | | | | | | | | | | | | | | | | | | | | | | | | | | |
| 9: | 10.2 | ↗ | | | | | | | | | | | | | | | | | | | | | | | | | | | | | | | | | |
| 10: | *10.6 | → | | | | | | | | | | | | | | | | | | | | | | | | | | | | | | | | | |
| Serie | 100.0 | | | | | | | | | | | | | | | | | | | | | | | | | | | | | | | | | | |
| Total | 100.0 | | | | | | | | | | | | | | | | | | | | | | | | | | | | | | | | | | |

| | | | | | | | | | | | | | | | | | | | | | | | | | | | | | | | | | | | |
|-----------------------|---|-----|-----|---|-----|------|---|-----|-------|---|-----|------|---|-----|-----|---|-----|------|---|-----|------|---|-----|-------|---|-----|-------|---|-----|------|---|-------|------|-------|-------|
| <p>20 Skud</p> | <table style="width:100%; border-collapse: collapse;"> <tr><td style="width:10%;">11:</td><td style="width:15%;">9.9</td><td style="width:10%; text-align: right;">↗</td></tr> <tr><td>12:</td><td>10.3</td><td style="text-align: right;">→</td></tr> <tr><td>13:</td><td>*10.6</td><td style="text-align: right;">↗</td></tr> <tr><td>14:</td><td>10.0</td><td style="text-align: right;">↗</td></tr> <tr><td>15:</td><td>9.7</td><td style="text-align: right;">↗</td></tr> <tr><td>16:</td><td>10.3</td><td style="text-align: right;">↘</td></tr> <tr><td>17:</td><td>10.1</td><td style="text-align: right;">↗</td></tr> <tr><td>18:</td><td>*10.7</td><td style="text-align: right;">↘</td></tr> <tr><td>19:</td><td>*10.6</td><td style="text-align: right;">↗</td></tr> <tr><td>20:</td><td>10.3</td><td style="text-align: right;">↘</td></tr> </table> <table border="1" style="width:100%; border-collapse: collapse; margin-top: 5px;"> <tr> <td style="width:80%;">Serie</td> <td style="text-align: right;">98.0</td> </tr> <tr> <td>Total</td> <td style="text-align: right;">198.0</td> </tr> </table> | 11: | 9.9 | ↗ | 12: | 10.3 | → | 13: | *10.6 | ↗ | 14: | 10.0 | ↗ | 15: | 9.7 | ↗ | 16: | 10.3 | ↘ | 17: | 10.1 | ↗ | 18: | *10.7 | ↘ | 19: | *10.6 | ↗ | 20: | 10.3 | ↘ | Serie | 98.0 | Total | 198.0 |
| 11: | 9.9 | ↗ | | | | | | | | | | | | | | | | | | | | | | | | | | | | | | | | | |
| 12: | 10.3 | → | | | | | | | | | | | | | | | | | | | | | | | | | | | | | | | | | |
| 13: | *10.6 | ↗ | | | | | | | | | | | | | | | | | | | | | | | | | | | | | | | | | |
| 14: | 10.0 | ↗ | | | | | | | | | | | | | | | | | | | | | | | | | | | | | | | | | |
| 15: | 9.7 | ↗ | | | | | | | | | | | | | | | | | | | | | | | | | | | | | | | | | |
| 16: | 10.3 | ↘ | | | | | | | | | | | | | | | | | | | | | | | | | | | | | | | | | |
| 17: | 10.1 | ↗ | | | | | | | | | | | | | | | | | | | | | | | | | | | | | | | | | |
| 18: | *10.7 | ↘ | | | | | | | | | | | | | | | | | | | | | | | | | | | | | | | | | |
| 19: | *10.6 | ↗ | | | | | | | | | | | | | | | | | | | | | | | | | | | | | | | | | |
| 20: | 10.3 | ↘ | | | | | | | | | | | | | | | | | | | | | | | | | | | | | | | | | |
| Serie | 98.0 | | | | | | | | | | | | | | | | | | | | | | | | | | | | | | | | | | |
| Total | 198.0 | | | | | | | | | | | | | | | | | | | | | | | | | | | | | | | | | | |

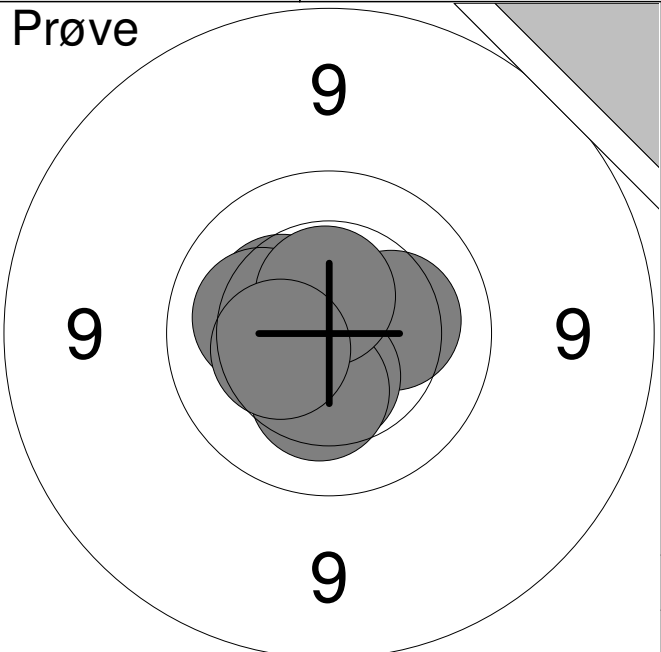
| | | | | | | | | | | | | | | | | | | | | | | | | | | |
|--|---|----|------|---|----|------|---|----|------|---|----|------|---|----|------|---|----|-------|---|----|------|---|-------|------|-------|-----|
| <p>Prøve</p>  | <table style="width:100%; border-collapse: collapse;"> <tr><td style="width:10%;">1:</td><td style="width:20%;">10.4</td><td style="width:10%; text-align: center;">↗</td></tr> <tr><td>2:</td><td>10.3</td><td style="text-align: center;">→</td></tr> <tr><td>3:</td><td>10.5</td><td style="text-align: center;">↓</td></tr> <tr><td>4:</td><td>10.3</td><td style="text-align: center;">↓</td></tr> <tr><td>5:</td><td>10.2</td><td style="text-align: center;">←</td></tr> <tr><td>6:</td><td>*10.5</td><td style="text-align: center;">↑</td></tr> <tr><td>7:</td><td>10.4</td><td style="text-align: center;">↖</td></tr> </table> <table border="1" style="width:100%; border-collapse: collapse; margin-top: 5px;"> <tr> <td style="width:80%;">Serie</td> <td style="text-align: right;">70.0</td> </tr> <tr> <td>Total</td> <td style="text-align: right;">0.0</td> </tr> </table> | 1: | 10.4 | ↗ | 2: | 10.3 | → | 3: | 10.5 | ↓ | 4: | 10.3 | ↓ | 5: | 10.2 | ← | 6: | *10.5 | ↑ | 7: | 10.4 | ↖ | Serie | 70.0 | Total | 0.0 |
| 1: | 10.4 | ↗ | | | | | | | | | | | | | | | | | | | | | | | | |
| 2: | 10.3 | → | | | | | | | | | | | | | | | | | | | | | | | | |
| 3: | 10.5 | ↓ | | | | | | | | | | | | | | | | | | | | | | | | |
| 4: | 10.3 | ↓ | | | | | | | | | | | | | | | | | | | | | | | | |
| 5: | 10.2 | ← | | | | | | | | | | | | | | | | | | | | | | | | |
| 6: | *10.5 | ↑ | | | | | | | | | | | | | | | | | | | | | | | | |
| 7: | 10.4 | ↖ | | | | | | | | | | | | | | | | | | | | | | | | |
| Serie | 70.0 | | | | | | | | | | | | | | | | | | | | | | | | | |
| Total | 0.0 | | | | | | | | | | | | | | | | | | | | | | | | | |

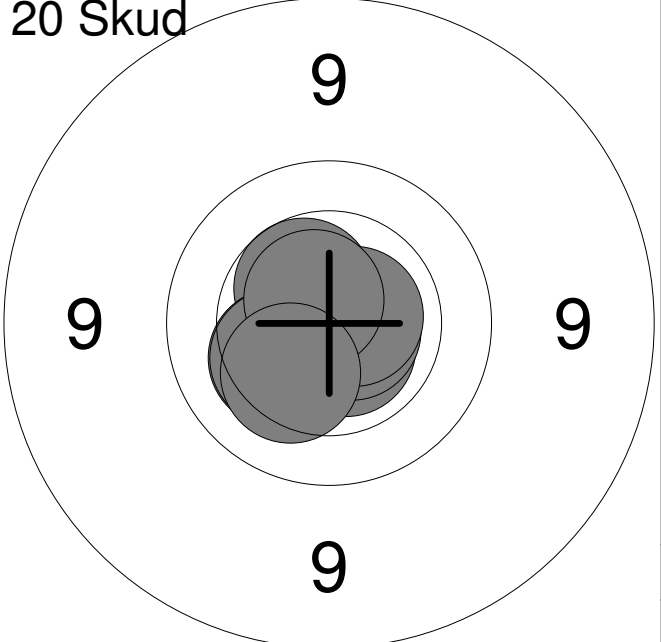
| | | | | | | | | | | | | | | | | | | | | | | | | | | | | | | | | | | | |
|---|--|----|-------|---|----|------|---|----|-------|---|----|------|---|----|-------|---|----|------|---|----|-------|---|----|-------|---|----|-------|---|-----|------|---|-------|-------|-------|-------|
| <p>20 Skud</p>  | <table style="width:100%; border-collapse: collapse;"> <tr><td style="width:10%;">1:</td><td style="width:20%;">*10.7</td><td style="width:10%; text-align: center;">↗</td></tr> <tr><td>2:</td><td>10.5</td><td style="text-align: center;">↗</td></tr> <tr><td>3:</td><td>*10.7</td><td style="text-align: center;">↘</td></tr> <tr><td>4:</td><td>10.3</td><td style="text-align: center;">↘</td></tr> <tr><td>5:</td><td>*10.6</td><td style="text-align: center;">↓</td></tr> <tr><td>6:</td><td>10.3</td><td style="text-align: center;">↘</td></tr> <tr><td>7:</td><td>*10.7</td><td style="text-align: center;">→</td></tr> <tr><td>8:</td><td>*10.7</td><td style="text-align: center;">→</td></tr> <tr><td>9:</td><td>*10.6</td><td style="text-align: center;">↗</td></tr> <tr><td>10:</td><td>10.3</td><td style="text-align: center;">↘</td></tr> </table> <table border="1" style="width:100%; border-collapse: collapse; margin-top: 5px;"> <tr> <td style="width:80%;">Serie</td> <td style="text-align: right;">100.0</td> </tr> <tr> <td>Total</td> <td style="text-align: right;">100.0</td> </tr> </table> | 1: | *10.7 | ↗ | 2: | 10.5 | ↗ | 3: | *10.7 | ↘ | 4: | 10.3 | ↘ | 5: | *10.6 | ↓ | 6: | 10.3 | ↘ | 7: | *10.7 | → | 8: | *10.7 | → | 9: | *10.6 | ↗ | 10: | 10.3 | ↘ | Serie | 100.0 | Total | 100.0 |
| 1: | *10.7 | ↗ | | | | | | | | | | | | | | | | | | | | | | | | | | | | | | | | | |
| 2: | 10.5 | ↗ | | | | | | | | | | | | | | | | | | | | | | | | | | | | | | | | | |
| 3: | *10.7 | ↘ | | | | | | | | | | | | | | | | | | | | | | | | | | | | | | | | | |
| 4: | 10.3 | ↘ | | | | | | | | | | | | | | | | | | | | | | | | | | | | | | | | | |
| 5: | *10.6 | ↓ | | | | | | | | | | | | | | | | | | | | | | | | | | | | | | | | | |
| 6: | 10.3 | ↘ | | | | | | | | | | | | | | | | | | | | | | | | | | | | | | | | | |
| 7: | *10.7 | → | | | | | | | | | | | | | | | | | | | | | | | | | | | | | | | | | |
| 8: | *10.7 | → | | | | | | | | | | | | | | | | | | | | | | | | | | | | | | | | | |
| 9: | *10.6 | ↗ | | | | | | | | | | | | | | | | | | | | | | | | | | | | | | | | | |
| 10: | 10.3 | ↘ | | | | | | | | | | | | | | | | | | | | | | | | | | | | | | | | | |
| Serie | 100.0 | | | | | | | | | | | | | | | | | | | | | | | | | | | | | | | | | | |
| Total | 100.0 | | | | | | | | | | | | | | | | | | | | | | | | | | | | | | | | | | |

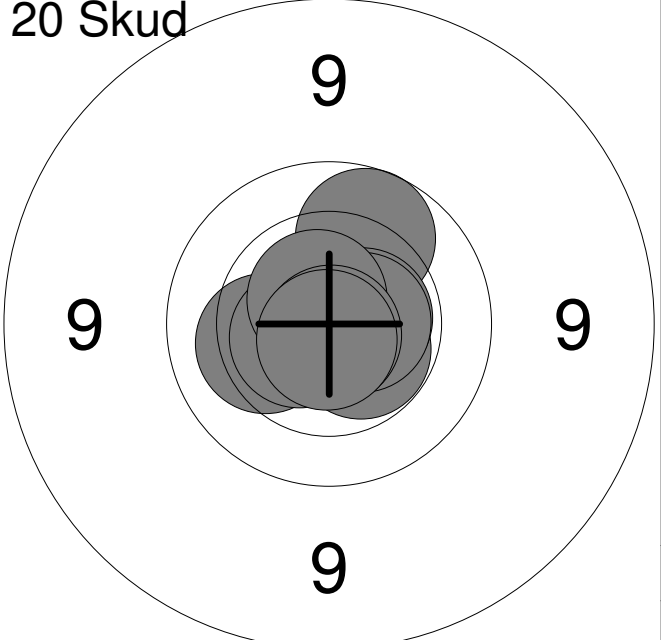
| | | | | | | | | | | | | | | | | | | | | | | | | | | | | | | | | | | | |
|--|---|-----|------|---|-----|-------|---|-----|-----|---|-----|-------|---|-----|-------|---|-----|-------|---|-----|-------|---|-----|-------|---|-----|-------|---|-----|-------|---|-------|------|-------|-------|
| <p>20 Skud</p>  | <table style="width:100%; border-collapse: collapse;"> <tr><td style="width:10%;">11:</td><td style="width:20%;">10.2</td><td style="width:10%; text-align: center;">↖</td></tr> <tr><td>12:</td><td>*10.9</td><td style="text-align: center;">↓</td></tr> <tr><td>13:</td><td>9.9</td><td style="text-align: center;">↗</td></tr> <tr><td>14:</td><td>*10.5</td><td style="text-align: center;">↘</td></tr> <tr><td>15:</td><td>*10.6</td><td style="text-align: center;">↖</td></tr> <tr><td>16:</td><td>*10.6</td><td style="text-align: center;">→</td></tr> <tr><td>17:</td><td>*10.6</td><td style="text-align: center;">→</td></tr> <tr><td>18:</td><td>*10.7</td><td style="text-align: center;">↗</td></tr> <tr><td>19:</td><td>*10.8</td><td style="text-align: center;">↓</td></tr> <tr><td>20:</td><td>*10.8</td><td style="text-align: center;">↓</td></tr> </table> <table border="1" style="width:100%; border-collapse: collapse; margin-top: 5px;"> <tr> <td style="width:80%;">Serie</td> <td style="text-align: right;">99.0</td> </tr> <tr> <td>Total</td> <td style="text-align: right;">199.0</td> </tr> </table> | 11: | 10.2 | ↖ | 12: | *10.9 | ↓ | 13: | 9.9 | ↗ | 14: | *10.5 | ↘ | 15: | *10.6 | ↖ | 16: | *10.6 | → | 17: | *10.6 | → | 18: | *10.7 | ↗ | 19: | *10.8 | ↓ | 20: | *10.8 | ↓ | Serie | 99.0 | Total | 199.0 |
| 11: | 10.2 | ↖ | | | | | | | | | | | | | | | | | | | | | | | | | | | | | | | | | |
| 12: | *10.9 | ↓ | | | | | | | | | | | | | | | | | | | | | | | | | | | | | | | | | |
| 13: | 9.9 | ↗ | | | | | | | | | | | | | | | | | | | | | | | | | | | | | | | | | |
| 14: | *10.5 | ↘ | | | | | | | | | | | | | | | | | | | | | | | | | | | | | | | | | |
| 15: | *10.6 | ↖ | | | | | | | | | | | | | | | | | | | | | | | | | | | | | | | | | |
| 16: | *10.6 | → | | | | | | | | | | | | | | | | | | | | | | | | | | | | | | | | | |
| 17: | *10.6 | → | | | | | | | | | | | | | | | | | | | | | | | | | | | | | | | | | |
| 18: | *10.7 | ↗ | | | | | | | | | | | | | | | | | | | | | | | | | | | | | | | | | |
| 19: | *10.8 | ↓ | | | | | | | | | | | | | | | | | | | | | | | | | | | | | | | | | |
| 20: | *10.8 | ↓ | | | | | | | | | | | | | | | | | | | | | | | | | | | | | | | | | |
| Serie | 99.0 | | | | | | | | | | | | | | | | | | | | | | | | | | | | | | | | | | |
| Total | 199.0 | | | | | | | | | | | | | | | | | | | | | | | | | | | | | | | | | | |

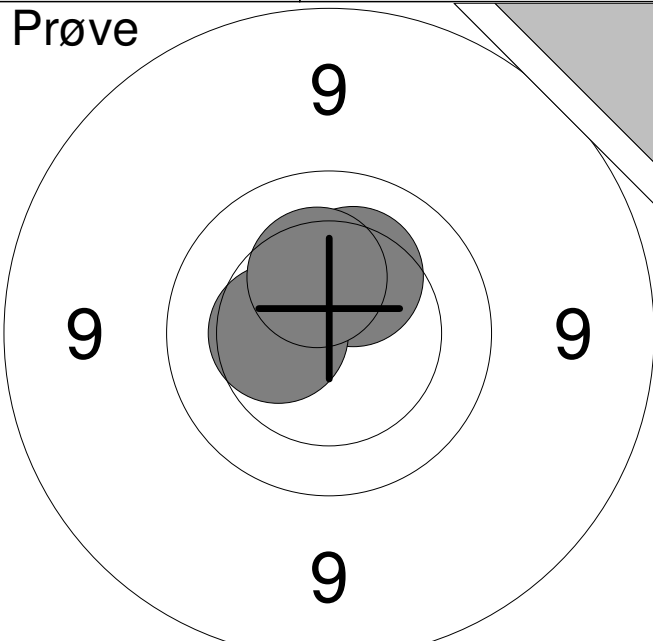
| | | | | | | | | | | | | | | |
|--|--|----|------|---|----|------|---|----|------|---|-------|------|-------|-----|
| <p>Prøve</p>  | <table style="width:100%; border-collapse: collapse;"> <tr><td style="width:10%;">1:</td><td style="width:20%;">10.3</td><td style="width:10%; text-align: center;">↗</td></tr> <tr><td>2:</td><td>10.4</td><td style="text-align: center;">←</td></tr> <tr><td>3:</td><td>10.3</td><td style="text-align: center;">↗</td></tr> </table> <table border="1" style="width:100%; border-collapse: collapse; margin-top: 5px;"> <tr> <td style="width:80%;">Serie</td> <td style="text-align: right;">30.0</td> </tr> <tr> <td>Total</td> <td style="text-align: right;">0.0</td> </tr> </table> | 1: | 10.3 | ↗ | 2: | 10.4 | ← | 3: | 10.3 | ↗ | Serie | 30.0 | Total | 0.0 |
| 1: | 10.3 | ↗ | | | | | | | | | | | | |
| 2: | 10.4 | ← | | | | | | | | | | | | |
| 3: | 10.3 | ↗ | | | | | | | | | | | | |
| Serie | 30.0 | | | | | | | | | | | | | |
| Total | 0.0 | | | | | | | | | | | | | |

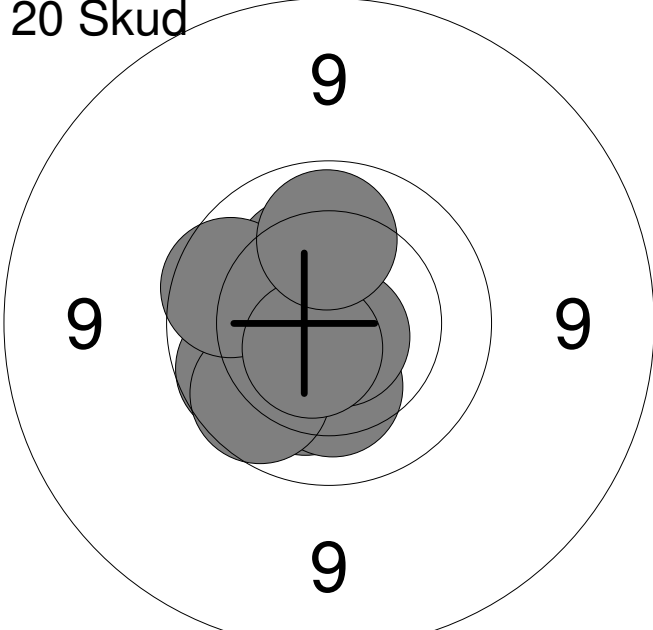
| | | | | | | | | | | | | | | | | | | | | | | | | | | | | | | | | | | | |
|---|--|----|-------|---|----|------|---|----|-----|---|----|------|---|----|------|---|----|-----|---|----|-------|---|----|-----|---|----|-------|---|-----|------|---|-------|------|-------|------|
| <p>20 Skud</p>  | <table style="width:100%; border-collapse: collapse;"> <tr><td style="width:10%;">1:</td><td style="width:20%;">*10.6</td><td style="width:10%; text-align: center;">←</td></tr> <tr><td>2:</td><td>10.2</td><td style="text-align: center;">↘</td></tr> <tr><td>3:</td><td>9.9</td><td style="text-align: center;">←</td></tr> <tr><td>4:</td><td>10.3</td><td style="text-align: center;">↗</td></tr> <tr><td>5:</td><td>10.3</td><td style="text-align: center;">↘</td></tr> <tr><td>6:</td><td>9.9</td><td style="text-align: center;">←</td></tr> <tr><td>7:</td><td>*10.8</td><td style="text-align: center;">↘</td></tr> <tr><td>8:</td><td>9.9</td><td style="text-align: center;">←</td></tr> <tr><td>9:</td><td>*10.6</td><td style="text-align: center;">↘</td></tr> <tr><td>10:</td><td>10.1</td><td style="text-align: center;">↗</td></tr> </table> <table border="1" style="width:100%; border-collapse: collapse; margin-top: 5px;"> <tr> <td style="width:80%;">Serie</td> <td style="text-align: right;">97.0</td> </tr> <tr> <td>Total</td> <td style="text-align: right;">97.0</td> </tr> </table> | 1: | *10.6 | ← | 2: | 10.2 | ↘ | 3: | 9.9 | ← | 4: | 10.3 | ↗ | 5: | 10.3 | ↘ | 6: | 9.9 | ← | 7: | *10.8 | ↘ | 8: | 9.9 | ← | 9: | *10.6 | ↘ | 10: | 10.1 | ↗ | Serie | 97.0 | Total | 97.0 |
| 1: | *10.6 | ← | | | | | | | | | | | | | | | | | | | | | | | | | | | | | | | | | |
| 2: | 10.2 | ↘ | | | | | | | | | | | | | | | | | | | | | | | | | | | | | | | | | |
| 3: | 9.9 | ← | | | | | | | | | | | | | | | | | | | | | | | | | | | | | | | | | |
| 4: | 10.3 | ↗ | | | | | | | | | | | | | | | | | | | | | | | | | | | | | | | | | |
| 5: | 10.3 | ↘ | | | | | | | | | | | | | | | | | | | | | | | | | | | | | | | | | |
| 6: | 9.9 | ← | | | | | | | | | | | | | | | | | | | | | | | | | | | | | | | | | |
| 7: | *10.8 | ↘ | | | | | | | | | | | | | | | | | | | | | | | | | | | | | | | | | |
| 8: | 9.9 | ← | | | | | | | | | | | | | | | | | | | | | | | | | | | | | | | | | |
| 9: | *10.6 | ↘ | | | | | | | | | | | | | | | | | | | | | | | | | | | | | | | | | |
| 10: | 10.1 | ↗ | | | | | | | | | | | | | | | | | | | | | | | | | | | | | | | | | |
| Serie | 97.0 | | | | | | | | | | | | | | | | | | | | | | | | | | | | | | | | | | |
| Total | 97.0 | | | | | | | | | | | | | | | | | | | | | | | | | | | | | | | | | | |

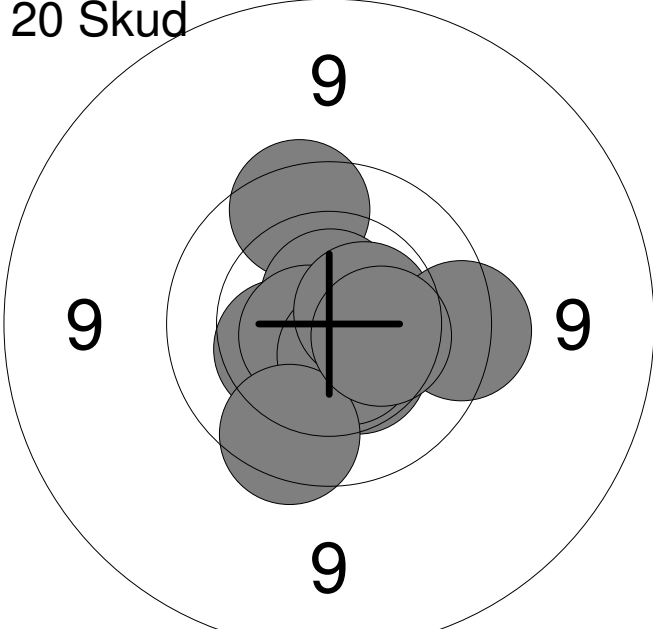
| | | | | | | | | | | | | | | | | | | | | | | | | | | | | | | | | | | | |
|--|---|-----|-----|---|-----|------|---|-----|------|---|-----|-------|---|-----|-------|---|-----|-------|---|-----|-------|---|-----|-----|---|-----|-----|---|-----|------|---|-------|------|-------|-------|
| <p>20 Skud</p>  | <table style="width:100%; border-collapse: collapse;"> <tr><td style="width:10%;">11:</td><td style="width:20%;">9.8</td><td style="width:10%; text-align: center;">↗</td></tr> <tr><td>12:</td><td>10.4</td><td style="text-align: center;">↘</td></tr> <tr><td>13:</td><td>10.4</td><td style="text-align: center;">←</td></tr> <tr><td>14:</td><td>*10.7</td><td style="text-align: center;">↗</td></tr> <tr><td>15:</td><td>*10.7</td><td style="text-align: center;">←</td></tr> <tr><td>16:</td><td>*10.6</td><td style="text-align: center;">↘</td></tr> <tr><td>17:</td><td>*10.6</td><td style="text-align: center;">→</td></tr> <tr><td>18:</td><td>9.7</td><td style="text-align: center;">→</td></tr> <tr><td>19:</td><td>9.8</td><td style="text-align: center;">↘</td></tr> <tr><td>20:</td><td>10.4</td><td style="text-align: center;">→</td></tr> </table> <table border="1" style="width:100%; border-collapse: collapse; margin-top: 5px;"> <tr> <td style="width:80%;">Serie</td> <td style="text-align: right;">97.0</td> </tr> <tr> <td>Total</td> <td style="text-align: right;">194.0</td> </tr> </table> | 11: | 9.8 | ↗ | 12: | 10.4 | ↘ | 13: | 10.4 | ← | 14: | *10.7 | ↗ | 15: | *10.7 | ← | 16: | *10.6 | ↘ | 17: | *10.6 | → | 18: | 9.7 | → | 19: | 9.8 | ↘ | 20: | 10.4 | → | Serie | 97.0 | Total | 194.0 |
| 11: | 9.8 | ↗ | | | | | | | | | | | | | | | | | | | | | | | | | | | | | | | | | |
| 12: | 10.4 | ↘ | | | | | | | | | | | | | | | | | | | | | | | | | | | | | | | | | |
| 13: | 10.4 | ← | | | | | | | | | | | | | | | | | | | | | | | | | | | | | | | | | |
| 14: | *10.7 | ↗ | | | | | | | | | | | | | | | | | | | | | | | | | | | | | | | | | |
| 15: | *10.7 | ← | | | | | | | | | | | | | | | | | | | | | | | | | | | | | | | | | |
| 16: | *10.6 | ↘ | | | | | | | | | | | | | | | | | | | | | | | | | | | | | | | | | |
| 17: | *10.6 | → | | | | | | | | | | | | | | | | | | | | | | | | | | | | | | | | | |
| 18: | 9.7 | → | | | | | | | | | | | | | | | | | | | | | | | | | | | | | | | | | |
| 19: | 9.8 | ↘ | | | | | | | | | | | | | | | | | | | | | | | | | | | | | | | | | |
| 20: | 10.4 | → | | | | | | | | | | | | | | | | | | | | | | | | | | | | | | | | | |
| Serie | 97.0 | | | | | | | | | | | | | | | | | | | | | | | | | | | | | | | | | | |
| Total | 194.0 | | | | | | | | | | | | | | | | | | | | | | | | | | | | | | | | | | |

| | | | | | | | | | | | | | | | | | | | | | | | | | | | | | |
|---------------------|---|----|------|---|----|-----|---|----|------|---|----|-------|---|----|-------|---|----|------|---|----|------|---|----|-------|---|-------|------|-------|-----|
| <p>Prøve</p> | <table style="width:100%; border-collapse: collapse;"> <tr><td style="width:10%;">1:</td><td style="width:15%;">10.4</td><td style="width:10%; text-align: right;">↖</td></tr> <tr><td>2:</td><td>9.9</td><td style="text-align: right;">↘</td></tr> <tr><td>3:</td><td>10.3</td><td style="text-align: right;">↘</td></tr> <tr><td>4:</td><td>*10.7</td><td style="text-align: right;">↘</td></tr> <tr><td>5:</td><td>*10.6</td><td style="text-align: right;">↖</td></tr> <tr><td>6:</td><td>10.0</td><td style="text-align: right;">→</td></tr> <tr><td>7:</td><td>10.3</td><td style="text-align: right;">↘</td></tr> <tr><td>8:</td><td>*10.7</td><td style="text-align: right;">↖</td></tr> </table> <table border="1" style="width:100%; border-collapse: collapse; margin-top: 5px;"> <tr> <td style="width:80%;">Serie</td> <td style="width:20%; text-align: right;">79.0</td> </tr> <tr> <td>Total</td> <td style="text-align: right;">0.0</td> </tr> </table> | 1: | 10.4 | ↖ | 2: | 9.9 | ↘ | 3: | 10.3 | ↘ | 4: | *10.7 | ↘ | 5: | *10.6 | ↖ | 6: | 10.0 | → | 7: | 10.3 | ↘ | 8: | *10.7 | ↖ | Serie | 79.0 | Total | 0.0 |
| 1: | 10.4 | ↖ | | | | | | | | | | | | | | | | | | | | | | | | | | | |
| 2: | 9.9 | ↘ | | | | | | | | | | | | | | | | | | | | | | | | | | | |
| 3: | 10.3 | ↘ | | | | | | | | | | | | | | | | | | | | | | | | | | | |
| 4: | *10.7 | ↘ | | | | | | | | | | | | | | | | | | | | | | | | | | | |
| 5: | *10.6 | ↖ | | | | | | | | | | | | | | | | | | | | | | | | | | | |
| 6: | 10.0 | → | | | | | | | | | | | | | | | | | | | | | | | | | | | |
| 7: | 10.3 | ↘ | | | | | | | | | | | | | | | | | | | | | | | | | | | |
| 8: | *10.7 | ↖ | | | | | | | | | | | | | | | | | | | | | | | | | | | |
| Serie | 79.0 | | | | | | | | | | | | | | | | | | | | | | | | | | | | |
| Total | 0.0 | | | | | | | | | | | | | | | | | | | | | | | | | | | | |

| | | | | | | | | | | | | | | | | | | | | | | | | | | | | | | | | | | | |
|-----------------------|--|----|-------|---|----|-------|---|----|------|---|----|-------|---|----|------|---|----|------|---|----|-----|---|----|-----|---|----|-------|---|-----|-------|---|-------|------|-------|------|
| <p>20 Skud</p> | <table style="width:100%; border-collapse: collapse;"> <tr><td style="width:10%;">1:</td><td style="width:15%;">*10.7</td><td style="width:10%; text-align: right;">↘</td></tr> <tr><td>2:</td><td>*10.7</td><td style="text-align: right;">↖</td></tr> <tr><td>3:</td><td>10.0</td><td style="text-align: right;">↖</td></tr> <tr><td>4:</td><td>*10.7</td><td style="text-align: right;">↘</td></tr> <tr><td>5:</td><td>10.3</td><td style="text-align: right;">→</td></tr> <tr><td>6:</td><td>10.4</td><td style="text-align: right;">↘</td></tr> <tr><td>7:</td><td>9.9</td><td style="text-align: right;">→</td></tr> <tr><td>8:</td><td>9.7</td><td style="text-align: right;">→</td></tr> <tr><td>9:</td><td>*10.8</td><td style="text-align: right;">↘</td></tr> <tr><td>10:</td><td>*10.6</td><td style="text-align: right;">↘</td></tr> </table> <table border="1" style="width:100%; border-collapse: collapse; margin-top: 5px;"> <tr> <td style="width:80%;">Serie</td> <td style="width:20%; text-align: right;">98.0</td> </tr> <tr> <td>Total</td> <td style="text-align: right;">98.0</td> </tr> </table> | 1: | *10.7 | ↘ | 2: | *10.7 | ↖ | 3: | 10.0 | ↖ | 4: | *10.7 | ↘ | 5: | 10.3 | → | 6: | 10.4 | ↘ | 7: | 9.9 | → | 8: | 9.7 | → | 9: | *10.8 | ↘ | 10: | *10.6 | ↘ | Serie | 98.0 | Total | 98.0 |
| 1: | *10.7 | ↘ | | | | | | | | | | | | | | | | | | | | | | | | | | | | | | | | | |
| 2: | *10.7 | ↖ | | | | | | | | | | | | | | | | | | | | | | | | | | | | | | | | | |
| 3: | 10.0 | ↖ | | | | | | | | | | | | | | | | | | | | | | | | | | | | | | | | | |
| 4: | *10.7 | ↘ | | | | | | | | | | | | | | | | | | | | | | | | | | | | | | | | | |
| 5: | 10.3 | → | | | | | | | | | | | | | | | | | | | | | | | | | | | | | | | | | |
| 6: | 10.4 | ↘ | | | | | | | | | | | | | | | | | | | | | | | | | | | | | | | | | |
| 7: | 9.9 | → | | | | | | | | | | | | | | | | | | | | | | | | | | | | | | | | | |
| 8: | 9.7 | → | | | | | | | | | | | | | | | | | | | | | | | | | | | | | | | | | |
| 9: | *10.8 | ↘ | | | | | | | | | | | | | | | | | | | | | | | | | | | | | | | | | |
| 10: | *10.6 | ↘ | | | | | | | | | | | | | | | | | | | | | | | | | | | | | | | | | |
| Serie | 98.0 | | | | | | | | | | | | | | | | | | | | | | | | | | | | | | | | | | |
| Total | 98.0 | | | | | | | | | | | | | | | | | | | | | | | | | | | | | | | | | | |

| | | | | | | | | | | | | | | | | | | | | | | | | | | | | | | | | | | | |
|-----------------------|---|-----|-------|---|-----|------|---|-----|------|---|-----|------|---|-----|------|---|-----|-------|---|-----|------|---|-----|------|---|-----|-----|---|-----|-----|---|-------|------|-------|-------|
| <p>20 Skud</p> | <table style="width:100%; border-collapse: collapse;"> <tr><td style="width:10%;">11:</td><td style="width:15%;">*10.6</td><td style="width:10%; text-align: right;">↗</td></tr> <tr><td>12:</td><td>10.2</td><td style="text-align: right;">↖</td></tr> <tr><td>13:</td><td>10.4</td><td style="text-align: right;">↘</td></tr> <tr><td>14:</td><td>10.0</td><td style="text-align: right;">→</td></tr> <tr><td>15:</td><td>10.2</td><td style="text-align: right;">↗</td></tr> <tr><td>16:</td><td>*10.7</td><td style="text-align: right;">↗</td></tr> <tr><td>17:</td><td>10.1</td><td style="text-align: right;">↗</td></tr> <tr><td>18:</td><td>10.1</td><td style="text-align: right;">↘</td></tr> <tr><td>19:</td><td>9.8</td><td style="text-align: right;">→</td></tr> <tr><td>20:</td><td>9.9</td><td style="text-align: right;">↗</td></tr> </table> <table border="1" style="width:100%; border-collapse: collapse; margin-top: 5px;"> <tr> <td style="width:80%;">Serie</td> <td style="width:20%; text-align: right;">98.0</td> </tr> <tr> <td>Total</td> <td style="text-align: right;">196.0</td> </tr> </table> | 11: | *10.6 | ↗ | 12: | 10.2 | ↖ | 13: | 10.4 | ↘ | 14: | 10.0 | → | 15: | 10.2 | ↗ | 16: | *10.7 | ↗ | 17: | 10.1 | ↗ | 18: | 10.1 | ↘ | 19: | 9.8 | → | 20: | 9.9 | ↗ | Serie | 98.0 | Total | 196.0 |
| 11: | *10.6 | ↗ | | | | | | | | | | | | | | | | | | | | | | | | | | | | | | | | | |
| 12: | 10.2 | ↖ | | | | | | | | | | | | | | | | | | | | | | | | | | | | | | | | | |
| 13: | 10.4 | ↘ | | | | | | | | | | | | | | | | | | | | | | | | | | | | | | | | | |
| 14: | 10.0 | → | | | | | | | | | | | | | | | | | | | | | | | | | | | | | | | | | |
| 15: | 10.2 | ↗ | | | | | | | | | | | | | | | | | | | | | | | | | | | | | | | | | |
| 16: | *10.7 | ↗ | | | | | | | | | | | | | | | | | | | | | | | | | | | | | | | | | |
| 17: | 10.1 | ↗ | | | | | | | | | | | | | | | | | | | | | | | | | | | | | | | | | |
| 18: | 10.1 | ↘ | | | | | | | | | | | | | | | | | | | | | | | | | | | | | | | | | |
| 19: | 9.8 | → | | | | | | | | | | | | | | | | | | | | | | | | | | | | | | | | | |
| 20: | 9.9 | ↗ | | | | | | | | | | | | | | | | | | | | | | | | | | | | | | | | | |
| Serie | 98.0 | | | | | | | | | | | | | | | | | | | | | | | | | | | | | | | | | | |
| Total | 196.0 | | | | | | | | | | | | | | | | | | | | | | | | | | | | | | | | | | |

| | | | | | | | | | | | | | | | | | | | | | | | | | | | | | |
|---------------------|---|----|-------|---|----|------|---|----|-------|---|----|------|---|----|-------|---|----|-------|---|----|------|---|----|-------|---|-------|------|-------|-----|
| <p>Prøve</p> | <table style="width:100%; border-collapse: collapse;"> <tr><td style="width:10%;">1:</td><td style="width:15%;">*10.7</td><td style="width:10%; text-align: right;">↗</td></tr> <tr><td>2:</td><td>10.4</td><td style="text-align: right;">↑</td></tr> <tr><td>3:</td><td>*10.7</td><td style="text-align: right;">↗</td></tr> <tr><td>4:</td><td>10.5</td><td style="text-align: right;">↗</td></tr> <tr><td>5:</td><td>*10.6</td><td style="text-align: right;">↑</td></tr> <tr><td>6:</td><td>*10.6</td><td style="text-align: right;">↑</td></tr> <tr><td>7:</td><td>10.1</td><td style="text-align: right;">↗</td></tr> <tr><td>8:</td><td>*10.7</td><td style="text-align: right;">→</td></tr> </table> <table border="1" style="width:100%; border-collapse: collapse; margin-top: 5px;"> <tr> <td style="width:80%;">Serie</td> <td style="text-align: right;">80.0</td> </tr> <tr> <td>Total</td> <td style="text-align: right;">0.0</td> </tr> </table> | 1: | *10.7 | ↗ | 2: | 10.4 | ↑ | 3: | *10.7 | ↗ | 4: | 10.5 | ↗ | 5: | *10.6 | ↑ | 6: | *10.6 | ↑ | 7: | 10.1 | ↗ | 8: | *10.7 | → | Serie | 80.0 | Total | 0.0 |
| 1: | *10.7 | ↗ | | | | | | | | | | | | | | | | | | | | | | | | | | | |
| 2: | 10.4 | ↑ | | | | | | | | | | | | | | | | | | | | | | | | | | | |
| 3: | *10.7 | ↗ | | | | | | | | | | | | | | | | | | | | | | | | | | | |
| 4: | 10.5 | ↗ | | | | | | | | | | | | | | | | | | | | | | | | | | | |
| 5: | *10.6 | ↑ | | | | | | | | | | | | | | | | | | | | | | | | | | | |
| 6: | *10.6 | ↑ | | | | | | | | | | | | | | | | | | | | | | | | | | | |
| 7: | 10.1 | ↗ | | | | | | | | | | | | | | | | | | | | | | | | | | | |
| 8: | *10.7 | → | | | | | | | | | | | | | | | | | | | | | | | | | | | |
| Serie | 80.0 | | | | | | | | | | | | | | | | | | | | | | | | | | | | |
| Total | 0.0 | | | | | | | | | | | | | | | | | | | | | | | | | | | | |

| | | | | | | | | | | | | | | | | | | | | | | | | | | | | | | | | | | | |
|-----------------------|---|----|-------|---|----|-------|---|----|------|---|----|-------|---|----|-------|---|----|-------|---|----|------|---|----|------|---|----|-------|---|-----|-------|---|-------|-------|-------|-------|
| <p>20 Skud</p> | <table style="width:100%; border-collapse: collapse;"> <tr><td style="width:10%;">1:</td><td style="width:15%;">*10.5</td><td style="width:10%; text-align: right;">↗</td></tr> <tr><td>2:</td><td>*10.7</td><td style="text-align: right;">↗</td></tr> <tr><td>3:</td><td>10.4</td><td style="text-align: right;">↗</td></tr> <tr><td>4:</td><td>*10.5</td><td style="text-align: right;">↖</td></tr> <tr><td>5:</td><td>*10.6</td><td style="text-align: right;">↓</td></tr> <tr><td>6:</td><td>*10.8</td><td style="text-align: right;">↗</td></tr> <tr><td>7:</td><td>10.5</td><td style="text-align: right;">↓</td></tr> <tr><td>8:</td><td>10.4</td><td style="text-align: right;">→</td></tr> <tr><td>9:</td><td>*10.7</td><td style="text-align: right;">↑</td></tr> <tr><td>10:</td><td>*10.7</td><td style="text-align: right;">↗</td></tr> </table> <table border="1" style="width:100%; border-collapse: collapse; margin-top: 5px;"> <tr> <td style="width:80%;">Serie</td> <td style="text-align: right;">100.0</td> </tr> <tr> <td>Total</td> <td style="text-align: right;">100.0</td> </tr> </table> | 1: | *10.5 | ↗ | 2: | *10.7 | ↗ | 3: | 10.4 | ↗ | 4: | *10.5 | ↖ | 5: | *10.6 | ↓ | 6: | *10.8 | ↗ | 7: | 10.5 | ↓ | 8: | 10.4 | → | 9: | *10.7 | ↑ | 10: | *10.7 | ↗ | Serie | 100.0 | Total | 100.0 |
| 1: | *10.5 | ↗ | | | | | | | | | | | | | | | | | | | | | | | | | | | | | | | | | |
| 2: | *10.7 | ↗ | | | | | | | | | | | | | | | | | | | | | | | | | | | | | | | | | |
| 3: | 10.4 | ↗ | | | | | | | | | | | | | | | | | | | | | | | | | | | | | | | | | |
| 4: | *10.5 | ↖ | | | | | | | | | | | | | | | | | | | | | | | | | | | | | | | | | |
| 5: | *10.6 | ↓ | | | | | | | | | | | | | | | | | | | | | | | | | | | | | | | | | |
| 6: | *10.8 | ↗ | | | | | | | | | | | | | | | | | | | | | | | | | | | | | | | | | |
| 7: | 10.5 | ↓ | | | | | | | | | | | | | | | | | | | | | | | | | | | | | | | | | |
| 8: | 10.4 | → | | | | | | | | | | | | | | | | | | | | | | | | | | | | | | | | | |
| 9: | *10.7 | ↑ | | | | | | | | | | | | | | | | | | | | | | | | | | | | | | | | | |
| 10: | *10.7 | ↗ | | | | | | | | | | | | | | | | | | | | | | | | | | | | | | | | | |
| Serie | 100.0 | | | | | | | | | | | | | | | | | | | | | | | | | | | | | | | | | | |
| Total | 100.0 | | | | | | | | | | | | | | | | | | | | | | | | | | | | | | | | | | |

| | | | | | | | | | | | | | | | | | | | | | | | | | | | | | | | | | | | |
|-----------------------|---|-----|-------|---|-----|-------|---|-----|-------|---|-----|------|---|-----|-------|---|-----|-------|---|-----|-------|---|-----|------|---|-----|------|---|-----|------|---|-------|-------|-------|-------|
| <p>20 Skud</p> | <table style="width:100%; border-collapse: collapse;"> <tr><td style="width:10%;">11:</td><td style="width:15%;">*10.6</td><td style="width:10%; text-align: right;">↖</td></tr> <tr><td>12:</td><td>*10.8</td><td style="text-align: right;">↖</td></tr> <tr><td>13:</td><td>*10.8</td><td style="text-align: right;">↗</td></tr> <tr><td>14:</td><td>10.4</td><td style="text-align: right;">↓</td></tr> <tr><td>15:</td><td>*10.8</td><td style="text-align: right;">↖</td></tr> <tr><td>16:</td><td>*10.8</td><td style="text-align: right;">↖</td></tr> <tr><td>17:</td><td>*10.5</td><td style="text-align: right;">↖</td></tr> <tr><td>18:</td><td>10.3</td><td style="text-align: right;">↖</td></tr> <tr><td>19:</td><td>10.5</td><td style="text-align: right;">↖</td></tr> <tr><td>20:</td><td>10.5</td><td style="text-align: right;">↓</td></tr> </table> <table border="1" style="width:100%; border-collapse: collapse; margin-top: 5px;"> <tr> <td style="width:80%;">Serie</td> <td style="text-align: right;">100.0</td> </tr> <tr> <td>Total</td> <td style="text-align: right;">200.0</td> </tr> </table> | 11: | *10.6 | ↖ | 12: | *10.8 | ↖ | 13: | *10.8 | ↗ | 14: | 10.4 | ↓ | 15: | *10.8 | ↖ | 16: | *10.8 | ↖ | 17: | *10.5 | ↖ | 18: | 10.3 | ↖ | 19: | 10.5 | ↖ | 20: | 10.5 | ↓ | Serie | 100.0 | Total | 200.0 |
| 11: | *10.6 | ↖ | | | | | | | | | | | | | | | | | | | | | | | | | | | | | | | | | |
| 12: | *10.8 | ↖ | | | | | | | | | | | | | | | | | | | | | | | | | | | | | | | | | |
| 13: | *10.8 | ↗ | | | | | | | | | | | | | | | | | | | | | | | | | | | | | | | | | |
| 14: | 10.4 | ↓ | | | | | | | | | | | | | | | | | | | | | | | | | | | | | | | | | |
| 15: | *10.8 | ↖ | | | | | | | | | | | | | | | | | | | | | | | | | | | | | | | | | |
| 16: | *10.8 | ↖ | | | | | | | | | | | | | | | | | | | | | | | | | | | | | | | | | |
| 17: | *10.5 | ↖ | | | | | | | | | | | | | | | | | | | | | | | | | | | | | | | | | |
| 18: | 10.3 | ↖ | | | | | | | | | | | | | | | | | | | | | | | | | | | | | | | | | |
| 19: | 10.5 | ↖ | | | | | | | | | | | | | | | | | | | | | | | | | | | | | | | | | |
| 20: | 10.5 | ↓ | | | | | | | | | | | | | | | | | | | | | | | | | | | | | | | | | |
| Serie | 100.0 | | | | | | | | | | | | | | | | | | | | | | | | | | | | | | | | | | |
| Total | 200.0 | | | | | | | | | | | | | | | | | | | | | | | | | | | | | | | | | | |

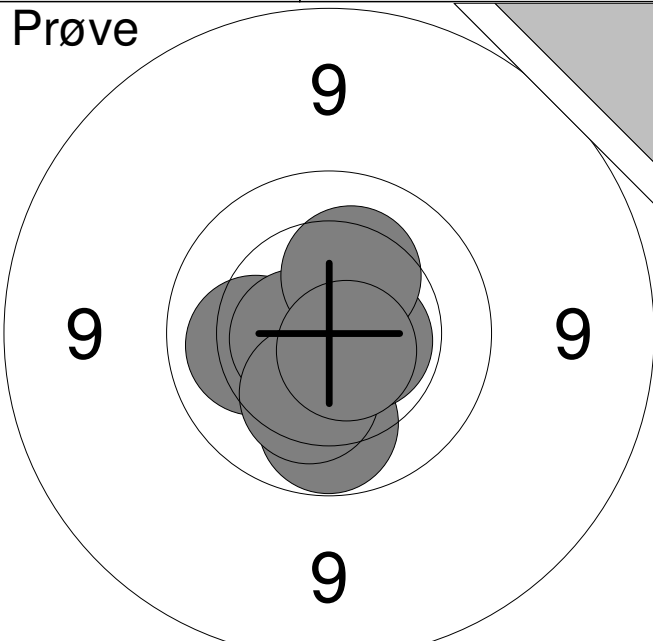
| | | | | | | | | | | | | | | | | | | | | | | | | | |
|--|---|-------|------|------|-------|-------|-----|----|------|---|----|-------|---|----|-------|---|----|------|---|----|------|---|----|-------|---|
| <p>Prøve</p>  | <table style="width:100%; border-collapse: collapse;"> <tr><td style="width:5%;">1:</td><td style="width:15%;">10.0</td><td style="width:10%; text-align: center;">↓</td></tr> <tr><td>2:</td><td>*10.6</td><td style="text-align: center;">↙</td></tr> <tr><td>3:</td><td>10.1</td><td style="text-align: center;">←</td></tr> <tr><td>4:</td><td>*10.6</td><td style="text-align: center;">←</td></tr> <tr><td>5:</td><td>*10.6</td><td style="text-align: center;">→</td></tr> <tr><td>6:</td><td>10.3</td><td style="text-align: center;">↙</td></tr> <tr><td>7:</td><td>10.3</td><td style="text-align: center;">↗</td></tr> <tr><td>8:</td><td>*10.7</td><td style="text-align: center;">↘</td></tr> </table> | 1: | 10.0 | ↓ | 2: | *10.6 | ↙ | 3: | 10.1 | ← | 4: | *10.6 | ← | 5: | *10.6 | → | 6: | 10.3 | ↙ | 7: | 10.3 | ↗ | 8: | *10.7 | ↘ |
| 1: | 10.0 | ↓ | | | | | | | | | | | | | | | | | | | | | | | |
| 2: | *10.6 | ↙ | | | | | | | | | | | | | | | | | | | | | | | |
| 3: | 10.1 | ← | | | | | | | | | | | | | | | | | | | | | | | |
| 4: | *10.6 | ← | | | | | | | | | | | | | | | | | | | | | | | |
| 5: | *10.6 | → | | | | | | | | | | | | | | | | | | | | | | | |
| 6: | 10.3 | ↙ | | | | | | | | | | | | | | | | | | | | | | | |
| 7: | 10.3 | ↗ | | | | | | | | | | | | | | | | | | | | | | | |
| 8: | *10.7 | ↘ | | | | | | | | | | | | | | | | | | | | | | | |
| <table style="width:100%; border-collapse: collapse;"> <tr> <td style="width:5%;">Serie</td> <td style="width:15%;"></td> <td style="width:10%; text-align: right;">80.0</td> </tr> <tr> <td>Total</td> <td></td> <td style="text-align: right;">0.0</td> </tr> </table> | | Serie | | 80.0 | Total | | 0.0 | | | | | | | | | | | | | | | | | | |
| Serie | | 80.0 | | | | | | | | | | | | | | | | | | | | | | | |
| Total | | 0.0 | | | | | | | | | | | | | | | | | | | | | | | |

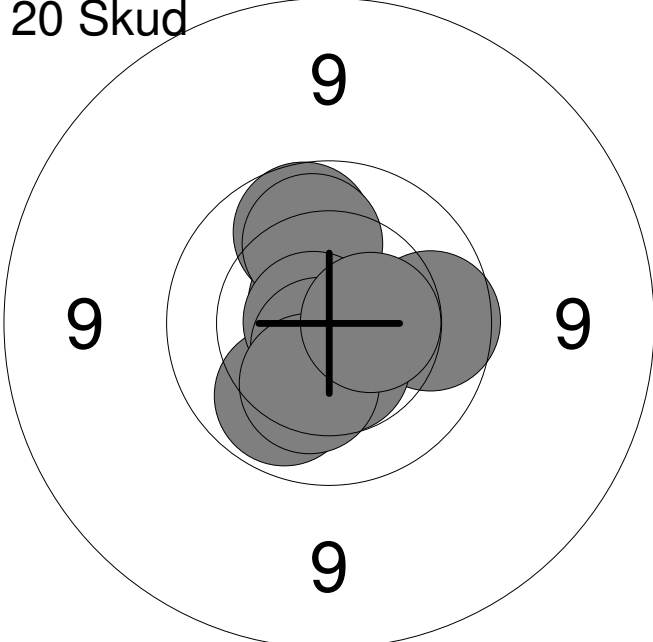
| | | | | | | | | | | | | | | | | | | | | | | | | | | | | | | | |
|---|---|-------|-----|------|-------|-----|------|----|-------|---|----|-------|---|----|------|---|----|------|---|----|-------|---|----|-------|---|----|------|---|-----|-------|---|
| <p>20 Skud</p>  | <table style="width:100%; border-collapse: collapse;"> <tr><td style="width:5%;">1:</td><td style="width:15%;">9.9</td><td style="width:10%; text-align: center;">↖</td></tr> <tr><td>2:</td><td>9.9</td><td style="text-align: center;">→</td></tr> <tr><td>3:</td><td>*10.5</td><td style="text-align: center;">↘</td></tr> <tr><td>4:</td><td>*10.7</td><td style="text-align: center;">↗</td></tr> <tr><td>5:</td><td>10.1</td><td style="text-align: center;">↗</td></tr> <tr><td>6:</td><td>10.0</td><td style="text-align: center;">↙</td></tr> <tr><td>7:</td><td>*10.8</td><td style="text-align: center;">←</td></tr> <tr><td>8:</td><td>*10.7</td><td style="text-align: center;">↘</td></tr> <tr><td>9:</td><td>10.3</td><td style="text-align: center;">↘</td></tr> <tr><td>10:</td><td>*10.5</td><td style="text-align: center;">→</td></tr> </table> | 1: | 9.9 | ↖ | 2: | 9.9 | → | 3: | *10.5 | ↘ | 4: | *10.7 | ↗ | 5: | 10.1 | ↗ | 6: | 10.0 | ↙ | 7: | *10.8 | ← | 8: | *10.7 | ↘ | 9: | 10.3 | ↘ | 10: | *10.5 | → |
| 1: | 9.9 | ↖ | | | | | | | | | | | | | | | | | | | | | | | | | | | | | |
| 2: | 9.9 | → | | | | | | | | | | | | | | | | | | | | | | | | | | | | | |
| 3: | *10.5 | ↘ | | | | | | | | | | | | | | | | | | | | | | | | | | | | | |
| 4: | *10.7 | ↗ | | | | | | | | | | | | | | | | | | | | | | | | | | | | | |
| 5: | 10.1 | ↗ | | | | | | | | | | | | | | | | | | | | | | | | | | | | | |
| 6: | 10.0 | ↙ | | | | | | | | | | | | | | | | | | | | | | | | | | | | | |
| 7: | *10.8 | ← | | | | | | | | | | | | | | | | | | | | | | | | | | | | | |
| 8: | *10.7 | ↘ | | | | | | | | | | | | | | | | | | | | | | | | | | | | | |
| 9: | 10.3 | ↘ | | | | | | | | | | | | | | | | | | | | | | | | | | | | | |
| 10: | *10.5 | → | | | | | | | | | | | | | | | | | | | | | | | | | | | | | |
| <table style="width:100%; border-collapse: collapse;"> <tr> <td style="width:5%;">Serie</td> <td style="width:15%;"></td> <td style="width:10%; text-align: right;">98.0</td> </tr> <tr> <td>Total</td> <td></td> <td style="text-align: right;">98.0</td> </tr> </table> | | Serie | | 98.0 | Total | | 98.0 | | | | | | | | | | | | | | | | | | | | | | | | |
| Serie | | 98.0 | | | | | | | | | | | | | | | | | | | | | | | | | | | | | |
| Total | | 98.0 | | | | | | | | | | | | | | | | | | | | | | | | | | | | | |

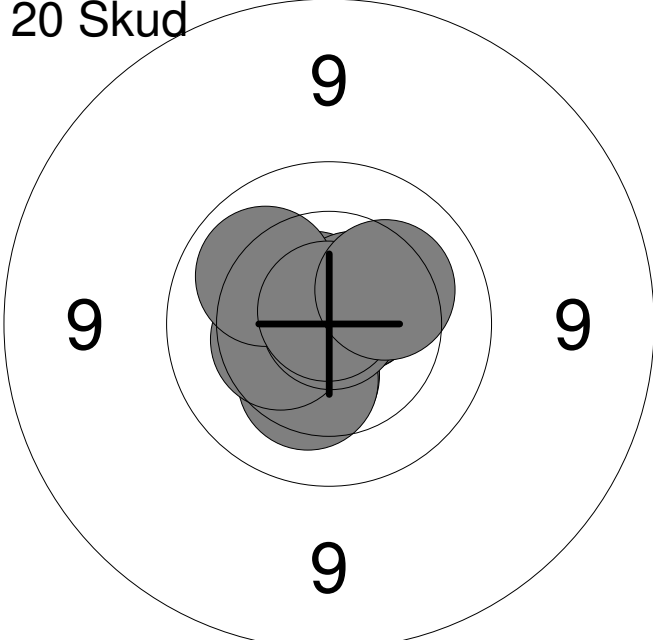
| | | | | | | | | | | | | | | | | | | | | | | | | | | | | | | | |
|---|--|-------|-------|-------|-------|-------|-------|-----|------|---|-----|------|---|-----|------|---|-----|-------|---|-----|-------|---|-----|------|---|-----|-------|---|-----|------|---|
| <p>20 Skud</p>  | <table style="width:100%; border-collapse: collapse;"> <tr><td style="width:5%;">11:</td><td style="width:15%;">*10.6</td><td style="width:10%; text-align: center;">↗</td></tr> <tr><td>12:</td><td>*10.6</td><td style="text-align: center;">↗</td></tr> <tr><td>13:</td><td>10.4</td><td style="text-align: center;">↘</td></tr> <tr><td>14:</td><td>10.3</td><td style="text-align: center;">↘</td></tr> <tr><td>15:</td><td>10.4</td><td style="text-align: center;">←</td></tr> <tr><td>16:</td><td>*10.6</td><td style="text-align: center;">↗</td></tr> <tr><td>17:</td><td>*10.9</td><td style="text-align: center;">↗</td></tr> <tr><td>18:</td><td>10.1</td><td style="text-align: center;">↖</td></tr> <tr><td>19:</td><td>*10.8</td><td style="text-align: center;">↑</td></tr> <tr><td>20:</td><td>10.2</td><td style="text-align: center;">↗</td></tr> </table> | 11: | *10.6 | ↗ | 12: | *10.6 | ↗ | 13: | 10.4 | ↘ | 14: | 10.3 | ↘ | 15: | 10.4 | ← | 16: | *10.6 | ↗ | 17: | *10.9 | ↗ | 18: | 10.1 | ↖ | 19: | *10.8 | ↑ | 20: | 10.2 | ↗ |
| 11: | *10.6 | ↗ | | | | | | | | | | | | | | | | | | | | | | | | | | | | | |
| 12: | *10.6 | ↗ | | | | | | | | | | | | | | | | | | | | | | | | | | | | | |
| 13: | 10.4 | ↘ | | | | | | | | | | | | | | | | | | | | | | | | | | | | | |
| 14: | 10.3 | ↘ | | | | | | | | | | | | | | | | | | | | | | | | | | | | | |
| 15: | 10.4 | ← | | | | | | | | | | | | | | | | | | | | | | | | | | | | | |
| 16: | *10.6 | ↗ | | | | | | | | | | | | | | | | | | | | | | | | | | | | | |
| 17: | *10.9 | ↗ | | | | | | | | | | | | | | | | | | | | | | | | | | | | | |
| 18: | 10.1 | ↖ | | | | | | | | | | | | | | | | | | | | | | | | | | | | | |
| 19: | *10.8 | ↑ | | | | | | | | | | | | | | | | | | | | | | | | | | | | | |
| 20: | 10.2 | ↗ | | | | | | | | | | | | | | | | | | | | | | | | | | | | | |
| <table style="width:100%; border-collapse: collapse;"> <tr> <td style="width:5%;">Serie</td> <td style="width:15%;"></td> <td style="width:10%; text-align: right;">100.0</td> </tr> <tr> <td>Total</td> <td></td> <td style="text-align: right;">198.0</td> </tr> </table> | | Serie | | 100.0 | Total | | 198.0 | | | | | | | | | | | | | | | | | | | | | | | | |
| Serie | | 100.0 | | | | | | | | | | | | | | | | | | | | | | | | | | | | | |
| Total | | 198.0 | | | | | | | | | | | | | | | | | | | | | | | | | | | | | |

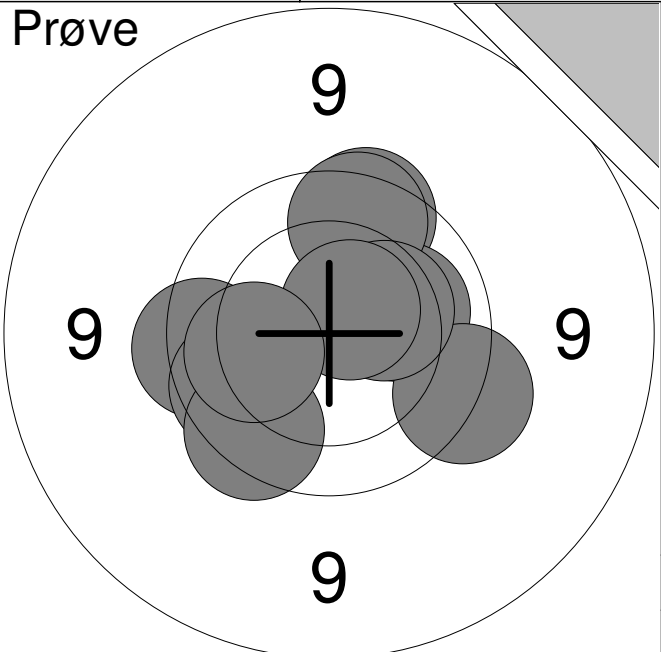
| | | | | | | | | | | | | | | | | | | | | | | | | | | | | | | | | | | | | | |
|--|---|------|-----|---|----|------|---|----|-----|---|----|-----|---|----|------|---|----|-------|---|----|-----|---|----|-----|---|----|-----|---|-----|------|---|-------|--|------|-------|--|-----|
| <p>Prøve</p>  | <table style="width:100%; border-collapse: collapse;"> <tr><td style="width:10%;">1:</td><td style="width:15%;">9.8</td><td style="width:10%; text-align: center;">↑</td></tr> <tr><td>2:</td><td>10.1</td><td style="text-align: center;">→</td></tr> <tr><td>3:</td><td>9.8</td><td style="text-align: center;">↑</td></tr> <tr><td>4:</td><td>9.6</td><td style="text-align: center;">→</td></tr> <tr><td>5:</td><td>10.3</td><td style="text-align: center;">→</td></tr> <tr><td>6:</td><td>*10.6</td><td style="text-align: center;">↗</td></tr> <tr><td>7:</td><td>9.7</td><td style="text-align: center;">←</td></tr> <tr><td>8:</td><td>9.9</td><td style="text-align: center;">↙</td></tr> <tr><td>9:</td><td>9.8</td><td style="text-align: center;">↘</td></tr> <tr><td>10:</td><td>10.1</td><td style="text-align: center;">←</td></tr> <tr><td colspan="2">Serie</td><td style="text-align: right;">94.0</td></tr> <tr><td colspan="2">Total</td><td style="text-align: right;">0.0</td></tr> </table> | 1: | 9.8 | ↑ | 2: | 10.1 | → | 3: | 9.8 | ↑ | 4: | 9.6 | → | 5: | 10.3 | → | 6: | *10.6 | ↗ | 7: | 9.7 | ← | 8: | 9.9 | ↙ | 9: | 9.8 | ↘ | 10: | 10.1 | ← | Serie | | 94.0 | Total | | 0.0 |
| 1: | 9.8 | ↑ | | | | | | | | | | | | | | | | | | | | | | | | | | | | | | | | | | | |
| 2: | 10.1 | → | | | | | | | | | | | | | | | | | | | | | | | | | | | | | | | | | | | |
| 3: | 9.8 | ↑ | | | | | | | | | | | | | | | | | | | | | | | | | | | | | | | | | | | |
| 4: | 9.6 | → | | | | | | | | | | | | | | | | | | | | | | | | | | | | | | | | | | | |
| 5: | 10.3 | → | | | | | | | | | | | | | | | | | | | | | | | | | | | | | | | | | | | |
| 6: | *10.6 | ↗ | | | | | | | | | | | | | | | | | | | | | | | | | | | | | | | | | | | |
| 7: | 9.7 | ← | | | | | | | | | | | | | | | | | | | | | | | | | | | | | | | | | | | |
| 8: | 9.9 | ↙ | | | | | | | | | | | | | | | | | | | | | | | | | | | | | | | | | | | |
| 9: | 9.8 | ↘ | | | | | | | | | | | | | | | | | | | | | | | | | | | | | | | | | | | |
| 10: | 10.1 | ← | | | | | | | | | | | | | | | | | | | | | | | | | | | | | | | | | | | |
| Serie | | 94.0 | | | | | | | | | | | | | | | | | | | | | | | | | | | | | | | | | | | |
| Total | | 0.0 | | | | | | | | | | | | | | | | | | | | | | | | | | | | | | | | | | | |

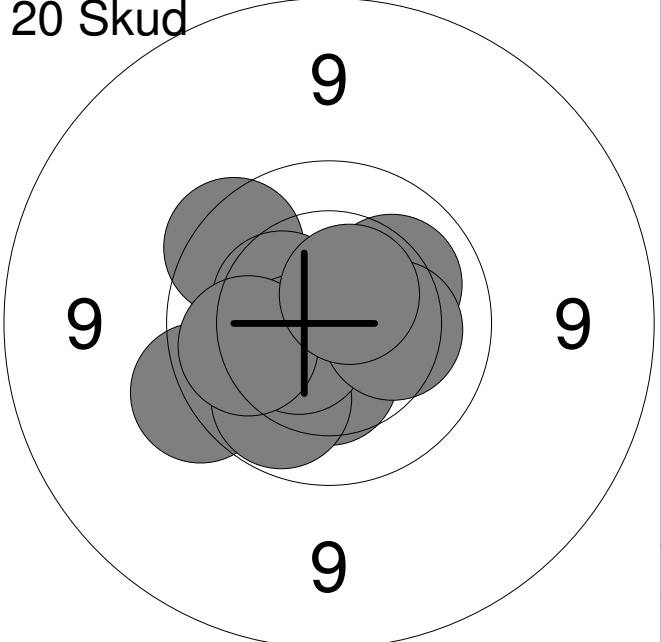
| | | | | | | | | | | | | | | | | | | | | | | | | | | | | | | | | | | | | | |
|---|---|------|------|---|----|------|---|----|-----|---|----|-----|---|----|------|---|----|------|---|----|-------|---|----|------|---|----|------|---|-----|-------|---|-------|--|------|-------|--|------|
| <p>20 Skud</p>  | <table style="width:100%; border-collapse: collapse;"> <tr><td style="width:10%;">1:</td><td style="width:15%;">10.4</td><td style="width:10%; text-align: center;">↓</td></tr> <tr><td>2:</td><td>10.2</td><td style="text-align: center;">↗</td></tr> <tr><td>3:</td><td>9.6</td><td style="text-align: center;">↙</td></tr> <tr><td>4:</td><td>9.8</td><td style="text-align: center;">↗</td></tr> <tr><td>5:</td><td>10.0</td><td style="text-align: center;">↘</td></tr> <tr><td>6:</td><td>10.4</td><td style="text-align: center;">↙</td></tr> <tr><td>7:</td><td>*10.5</td><td style="text-align: center;">↙</td></tr> <tr><td>8:</td><td>10.3</td><td style="text-align: center;">→</td></tr> <tr><td>9:</td><td>10.0</td><td style="text-align: center;">←</td></tr> <tr><td>10:</td><td>*10.6</td><td style="text-align: center;">↗</td></tr> <tr><td colspan="2">Serie</td><td style="text-align: right;">98.0</td></tr> <tr><td colspan="2">Total</td><td style="text-align: right;">98.0</td></tr> </table> | 1: | 10.4 | ↓ | 2: | 10.2 | ↗ | 3: | 9.6 | ↙ | 4: | 9.8 | ↗ | 5: | 10.0 | ↘ | 6: | 10.4 | ↙ | 7: | *10.5 | ↙ | 8: | 10.3 | → | 9: | 10.0 | ← | 10: | *10.6 | ↗ | Serie | | 98.0 | Total | | 98.0 |
| 1: | 10.4 | ↓ | | | | | | | | | | | | | | | | | | | | | | | | | | | | | | | | | | | |
| 2: | 10.2 | ↗ | | | | | | | | | | | | | | | | | | | | | | | | | | | | | | | | | | | |
| 3: | 9.6 | ↙ | | | | | | | | | | | | | | | | | | | | | | | | | | | | | | | | | | | |
| 4: | 9.8 | ↗ | | | | | | | | | | | | | | | | | | | | | | | | | | | | | | | | | | | |
| 5: | 10.0 | ↘ | | | | | | | | | | | | | | | | | | | | | | | | | | | | | | | | | | | |
| 6: | 10.4 | ↙ | | | | | | | | | | | | | | | | | | | | | | | | | | | | | | | | | | | |
| 7: | *10.5 | ↙ | | | | | | | | | | | | | | | | | | | | | | | | | | | | | | | | | | | |
| 8: | 10.3 | → | | | | | | | | | | | | | | | | | | | | | | | | | | | | | | | | | | | |
| 9: | 10.0 | ← | | | | | | | | | | | | | | | | | | | | | | | | | | | | | | | | | | | |
| 10: | *10.6 | ↗ | | | | | | | | | | | | | | | | | | | | | | | | | | | | | | | | | | | |
| Serie | | 98.0 | | | | | | | | | | | | | | | | | | | | | | | | | | | | | | | | | | | |
| Total | | 98.0 | | | | | | | | | | | | | | | | | | | | | | | | | | | | | | | | | | | |

| | | | | | | | | | | | | | | | | | | | | | | | | | | | | | | | | | | | | | |
|--|---|-------|------|---|-----|------|---|-----|------|---|-----|------|---|-----|------|---|-----|------|---|-----|-------|---|-----|-----|---|-----|-----|---|-----|-----|---|-------|--|------|-------|--|-------|
| <p>20 Skud</p>  | <table style="width:100%; border-collapse: collapse;"> <tr><td style="width:10%;">11:</td><td style="width:15%;">10.3</td><td style="width:10%; text-align: center;">↗</td></tr> <tr><td>12:</td><td>10.4</td><td style="text-align: center;">↙</td></tr> <tr><td>13:</td><td>10.3</td><td style="text-align: center;">↙</td></tr> <tr><td>14:</td><td>10.1</td><td style="text-align: center;">↘</td></tr> <tr><td>15:</td><td>10.5</td><td style="text-align: center;">↓</td></tr> <tr><td>16:</td><td>10.4</td><td style="text-align: center;">←</td></tr> <tr><td>17:</td><td>*10.8</td><td style="text-align: center;">↗</td></tr> <tr><td>18:</td><td>9.5</td><td style="text-align: center;">↑</td></tr> <tr><td>19:</td><td>9.8</td><td style="text-align: center;">↙</td></tr> <tr><td>20:</td><td>9.9</td><td style="text-align: center;">←</td></tr> <tr><td colspan="2">Serie</td><td style="text-align: right;">97.0</td></tr> <tr><td colspan="2">Total</td><td style="text-align: right;">195.0</td></tr> </table> | 11: | 10.3 | ↗ | 12: | 10.4 | ↙ | 13: | 10.3 | ↙ | 14: | 10.1 | ↘ | 15: | 10.5 | ↓ | 16: | 10.4 | ← | 17: | *10.8 | ↗ | 18: | 9.5 | ↑ | 19: | 9.8 | ↙ | 20: | 9.9 | ← | Serie | | 97.0 | Total | | 195.0 |
| 11: | 10.3 | ↗ | | | | | | | | | | | | | | | | | | | | | | | | | | | | | | | | | | | |
| 12: | 10.4 | ↙ | | | | | | | | | | | | | | | | | | | | | | | | | | | | | | | | | | | |
| 13: | 10.3 | ↙ | | | | | | | | | | | | | | | | | | | | | | | | | | | | | | | | | | | |
| 14: | 10.1 | ↘ | | | | | | | | | | | | | | | | | | | | | | | | | | | | | | | | | | | |
| 15: | 10.5 | ↓ | | | | | | | | | | | | | | | | | | | | | | | | | | | | | | | | | | | |
| 16: | 10.4 | ← | | | | | | | | | | | | | | | | | | | | | | | | | | | | | | | | | | | |
| 17: | *10.8 | ↗ | | | | | | | | | | | | | | | | | | | | | | | | | | | | | | | | | | | |
| 18: | 9.5 | ↑ | | | | | | | | | | | | | | | | | | | | | | | | | | | | | | | | | | | |
| 19: | 9.8 | ↙ | | | | | | | | | | | | | | | | | | | | | | | | | | | | | | | | | | | |
| 20: | 9.9 | ← | | | | | | | | | | | | | | | | | | | | | | | | | | | | | | | | | | | |
| Serie | | 97.0 | | | | | | | | | | | | | | | | | | | | | | | | | | | | | | | | | | | |
| Total | | 195.0 | | | | | | | | | | | | | | | | | | | | | | | | | | | | | | | | | | | |

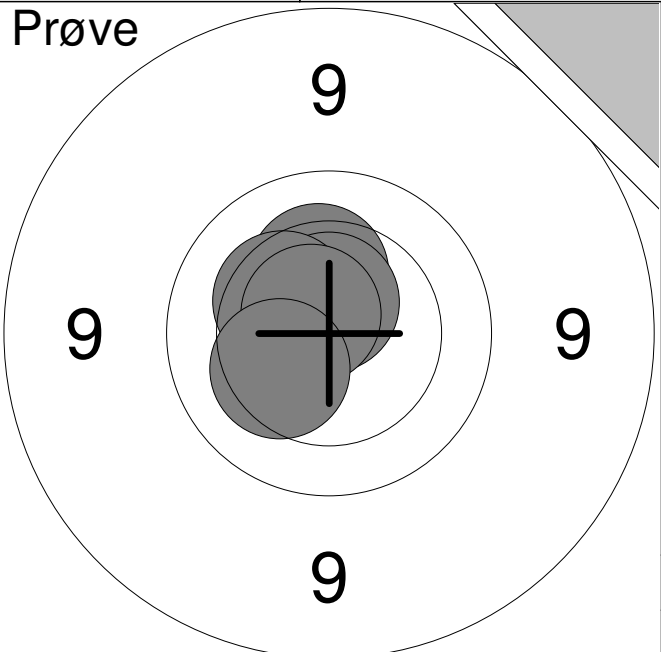
| | | | | | | | | | | | | | | | | | | | | |
|--|---|----|------|---|----|-------|---|----|------|---|----|-------|---|----|------|---|-------|------|-------|-----|
| <p>Prøve</p>  | <table style="width:100%; border-collapse: collapse;"> <tr><td style="width:10%;">1:</td><td style="width:15%;">10.3</td><td style="width:10%; text-align: right;">↑</td></tr> <tr><td>2:</td><td>*10.6</td><td style="text-align: right;">↑</td></tr> <tr><td>3:</td><td>10.3</td><td style="text-align: right;">↗</td></tr> <tr><td>4:</td><td>*10.7</td><td style="text-align: right;">↗</td></tr> <tr><td>5:</td><td>10.3</td><td style="text-align: right;">↙</td></tr> </table> <table border="1" style="width:100%; border-collapse: collapse; margin-top: 5px;"> <tr> <td style="width:80%;">Serie</td> <td style="text-align: right;">50.0</td> </tr> <tr> <td>Total</td> <td style="text-align: right;">0.0</td> </tr> </table> | 1: | 10.3 | ↑ | 2: | *10.6 | ↑ | 3: | 10.3 | ↗ | 4: | *10.7 | ↗ | 5: | 10.3 | ↙ | Serie | 50.0 | Total | 0.0 |
| 1: | 10.3 | ↑ | | | | | | | | | | | | | | | | | | |
| 2: | *10.6 | ↑ | | | | | | | | | | | | | | | | | | |
| 3: | 10.3 | ↗ | | | | | | | | | | | | | | | | | | |
| 4: | *10.7 | ↗ | | | | | | | | | | | | | | | | | | |
| 5: | 10.3 | ↙ | | | | | | | | | | | | | | | | | | |
| Serie | 50.0 | | | | | | | | | | | | | | | | | | | |
| Total | 0.0 | | | | | | | | | | | | | | | | | | | |

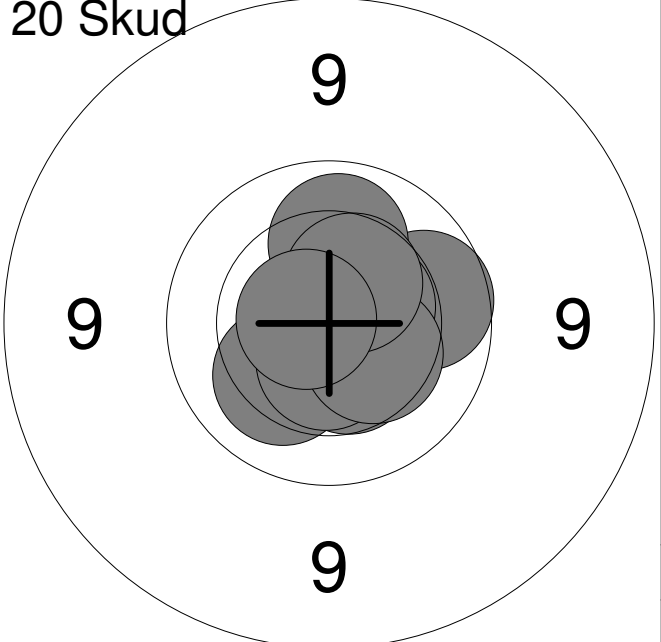
| | | | | | | | | | | | | | | | | | | | | | | | | | | | | | | | | | | | |
|---|--|----|-----|---|----|-------|---|----|------|---|----|------|---|----|------|---|----|-------|---|----|------|---|----|------|---|----|------|---|-----|-------|---|-------|------|-------|------|
| <p>20 Skud</p>  | <table style="width:100%; border-collapse: collapse;"> <tr><td style="width:10%;">1:</td><td style="width:15%;">9.9</td><td style="width:10%; text-align: right;">→</td></tr> <tr><td>2:</td><td>*10.5</td><td style="text-align: right;">→</td></tr> <tr><td>3:</td><td>10.5</td><td style="text-align: right;">↙</td></tr> <tr><td>4:</td><td>10.5</td><td style="text-align: right;">↙</td></tr> <tr><td>5:</td><td>10.2</td><td style="text-align: right;">↙</td></tr> <tr><td>6:</td><td>*10.5</td><td style="text-align: right;">↓</td></tr> <tr><td>7:</td><td>10.4</td><td style="text-align: right;">↘</td></tr> <tr><td>8:</td><td>10.1</td><td style="text-align: right;">↑</td></tr> <tr><td>9:</td><td>10.4</td><td style="text-align: right;">↗</td></tr> <tr><td>10:</td><td>*10.7</td><td style="text-align: right;">←</td></tr> </table> <table border="1" style="width:100%; border-collapse: collapse; margin-top: 5px;"> <tr> <td style="width:80%;">Serie</td> <td style="text-align: right;">99.0</td> </tr> <tr> <td>Total</td> <td style="text-align: right;">99.0</td> </tr> </table> | 1: | 9.9 | → | 2: | *10.5 | → | 3: | 10.5 | ↙ | 4: | 10.5 | ↙ | 5: | 10.2 | ↙ | 6: | *10.5 | ↓ | 7: | 10.4 | ↘ | 8: | 10.1 | ↑ | 9: | 10.4 | ↗ | 10: | *10.7 | ← | Serie | 99.0 | Total | 99.0 |
| 1: | 9.9 | → | | | | | | | | | | | | | | | | | | | | | | | | | | | | | | | | | |
| 2: | *10.5 | → | | | | | | | | | | | | | | | | | | | | | | | | | | | | | | | | | |
| 3: | 10.5 | ↙ | | | | | | | | | | | | | | | | | | | | | | | | | | | | | | | | | |
| 4: | 10.5 | ↙ | | | | | | | | | | | | | | | | | | | | | | | | | | | | | | | | | |
| 5: | 10.2 | ↙ | | | | | | | | | | | | | | | | | | | | | | | | | | | | | | | | | |
| 6: | *10.5 | ↓ | | | | | | | | | | | | | | | | | | | | | | | | | | | | | | | | | |
| 7: | 10.4 | ↘ | | | | | | | | | | | | | | | | | | | | | | | | | | | | | | | | | |
| 8: | 10.1 | ↑ | | | | | | | | | | | | | | | | | | | | | | | | | | | | | | | | | |
| 9: | 10.4 | ↗ | | | | | | | | | | | | | | | | | | | | | | | | | | | | | | | | | |
| 10: | *10.7 | ← | | | | | | | | | | | | | | | | | | | | | | | | | | | | | | | | | |
| Serie | 99.0 | | | | | | | | | | | | | | | | | | | | | | | | | | | | | | | | | | |
| Total | 99.0 | | | | | | | | | | | | | | | | | | | | | | | | | | | | | | | | | | |

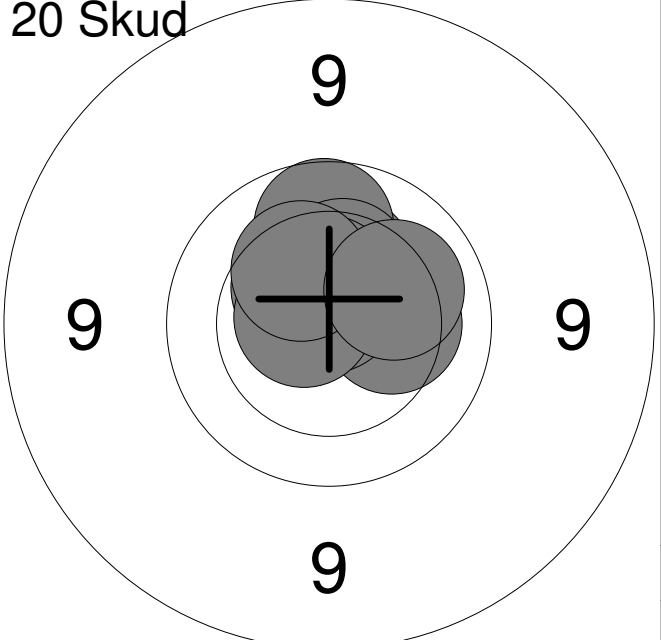
| | | | | | | | | | | | | | | | | | | | | | | | | | | | | | | | | | | | |
|--|--|-----|------|---|-----|------|---|-----|-----|---|-----|------|---|-----|-------|---|-----|------|---|-----|-------|---|-----|-------|---|-----|------|---|-----|------|---|-------|------|-------|-------|
| <p>20 Skud</p>  | <table style="width:100%; border-collapse: collapse;"> <tr><td style="width:10%;">11:</td><td style="width:15%;">10.5</td><td style="width:10%; text-align: right;">↖</td></tr> <tr><td>12:</td><td>10.3</td><td style="text-align: right;">↑</td></tr> <tr><td>13:</td><td>9.9</td><td style="text-align: right;">↑</td></tr> <tr><td>14:</td><td>10.3</td><td style="text-align: right;">↑</td></tr> <tr><td>15:</td><td>*10.5</td><td style="text-align: right;">↑</td></tr> <tr><td>16:</td><td>10.3</td><td style="text-align: right;">→</td></tr> <tr><td>17:</td><td>*10.7</td><td style="text-align: right;">↑</td></tr> <tr><td>18:</td><td>*10.7</td><td style="text-align: right;">←</td></tr> <tr><td>19:</td><td>10.3</td><td style="text-align: right;">↖</td></tr> <tr><td>20:</td><td>10.2</td><td style="text-align: right;">↗</td></tr> </table> <table border="1" style="width:100%; border-collapse: collapse; margin-top: 5px;"> <tr> <td style="width:80%;">Serie</td> <td style="text-align: right;">99.0</td> </tr> <tr> <td>Total</td> <td style="text-align: right;">198.0</td> </tr> </table> | 11: | 10.5 | ↖ | 12: | 10.3 | ↑ | 13: | 9.9 | ↑ | 14: | 10.3 | ↑ | 15: | *10.5 | ↑ | 16: | 10.3 | → | 17: | *10.7 | ↑ | 18: | *10.7 | ← | 19: | 10.3 | ↖ | 20: | 10.2 | ↗ | Serie | 99.0 | Total | 198.0 |
| 11: | 10.5 | ↖ | | | | | | | | | | | | | | | | | | | | | | | | | | | | | | | | | |
| 12: | 10.3 | ↑ | | | | | | | | | | | | | | | | | | | | | | | | | | | | | | | | | |
| 13: | 9.9 | ↑ | | | | | | | | | | | | | | | | | | | | | | | | | | | | | | | | | |
| 14: | 10.3 | ↑ | | | | | | | | | | | | | | | | | | | | | | | | | | | | | | | | | |
| 15: | *10.5 | ↑ | | | | | | | | | | | | | | | | | | | | | | | | | | | | | | | | | |
| 16: | 10.3 | → | | | | | | | | | | | | | | | | | | | | | | | | | | | | | | | | | |
| 17: | *10.7 | ↑ | | | | | | | | | | | | | | | | | | | | | | | | | | | | | | | | | |
| 18: | *10.7 | ← | | | | | | | | | | | | | | | | | | | | | | | | | | | | | | | | | |
| 19: | 10.3 | ↖ | | | | | | | | | | | | | | | | | | | | | | | | | | | | | | | | | |
| 20: | 10.2 | ↗ | | | | | | | | | | | | | | | | | | | | | | | | | | | | | | | | | |
| Serie | 99.0 | | | | | | | | | | | | | | | | | | | | | | | | | | | | | | | | | | |
| Total | 198.0 | | | | | | | | | | | | | | | | | | | | | | | | | | | | | | | | | | |

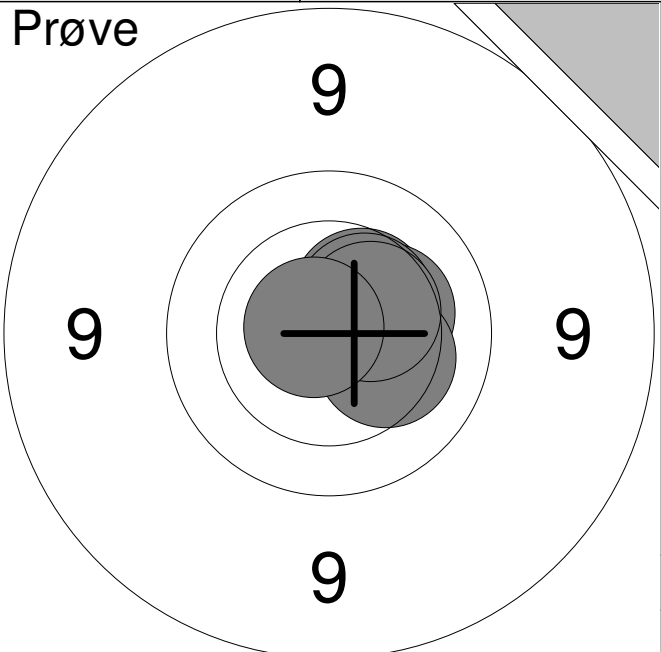
| | | | | | | | | | | | | | | | | | | | | | | |
|--|--|-------|------|-------|-----|------|---|----|------|---|----|-------|---|----|------|---|----|------|---|----|-------|---|
| <p>Prøve</p>  | <table style="width:100%; border-collapse: collapse;"> <tr><td style="width:10%;">1:</td><td style="width:15%;">10.4</td><td style="width:10%; text-align: center;">↗</td></tr> <tr><td>2:</td><td>10.3</td><td style="text-align: center;">→</td></tr> <tr><td>3:</td><td>10.4</td><td style="text-align: center;">↗</td></tr> <tr><td>4:</td><td>*10.6</td><td style="text-align: center;">→</td></tr> <tr><td>5:</td><td>10.3</td><td style="text-align: center;">↘</td></tr> <tr><td>6:</td><td>10.4</td><td style="text-align: center;">↗</td></tr> <tr><td>7:</td><td>*10.8</td><td style="text-align: center;">↖</td></tr> </table> | 1: | 10.4 | ↗ | 2: | 10.3 | → | 3: | 10.4 | ↗ | 4: | *10.6 | → | 5: | 10.3 | ↘ | 6: | 10.4 | ↗ | 7: | *10.8 | ↖ |
| 1: | 10.4 | ↗ | | | | | | | | | | | | | | | | | | | | |
| 2: | 10.3 | → | | | | | | | | | | | | | | | | | | | | |
| 3: | 10.4 | ↗ | | | | | | | | | | | | | | | | | | | | |
| 4: | *10.6 | → | | | | | | | | | | | | | | | | | | | | |
| 5: | 10.3 | ↘ | | | | | | | | | | | | | | | | | | | | |
| 6: | 10.4 | ↗ | | | | | | | | | | | | | | | | | | | | |
| 7: | *10.8 | ↖ | | | | | | | | | | | | | | | | | | | | |
| | <table border="1" style="width:100%; border-collapse: collapse;"> <tr> <td style="width:80%;">Serie</td> <td style="text-align: right;">70.0</td> </tr> <tr> <td>Total</td> <td style="text-align: right;">0.0</td> </tr> </table> | Serie | 70.0 | Total | 0.0 | | | | | | | | | | | | | | | | | |
| Serie | 70.0 | | | | | | | | | | | | | | | | | | | | | |
| Total | 0.0 | | | | | | | | | | | | | | | | | | | | | |

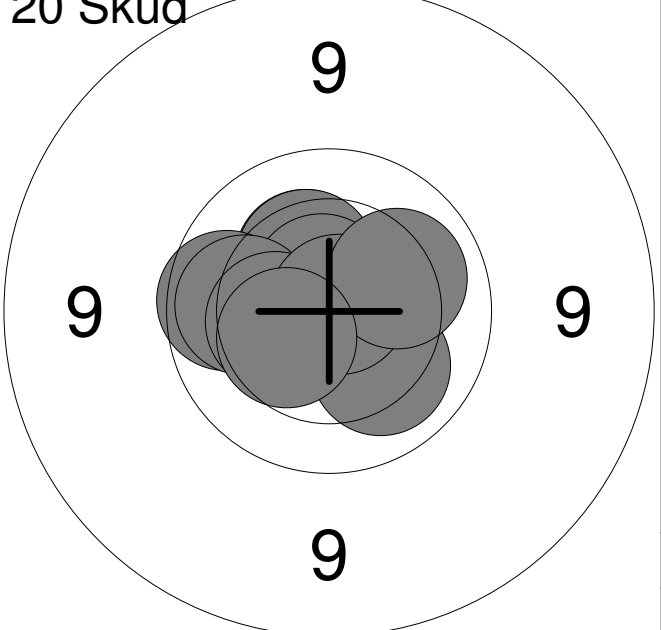
| | | | | | | | | | | | | | | | | | | | | | | | | | | | | | | | |
|---|--|-------|------|-------|------|------|---|----|-------|---|----|-----|---|----|------|---|----|------|---|----|------|---|----|-------|---|----|------|---|-----|------|---|
| <p>20 Skud</p>  | <table style="width:100%; border-collapse: collapse;"> <tr><td style="width:10%;">1:</td><td style="width:15%;">10.3</td><td style="width:10%; text-align: center;">↗</td></tr> <tr><td>2:</td><td>10.3</td><td style="text-align: center;">↗</td></tr> <tr><td>3:</td><td>*10.6</td><td style="text-align: center;">↗</td></tr> <tr><td>4:</td><td>9.9</td><td style="text-align: center;">←</td></tr> <tr><td>5:</td><td>10.0</td><td style="text-align: center;">←</td></tr> <tr><td>6:</td><td>10.4</td><td style="text-align: center;">←</td></tr> <tr><td>7:</td><td>10.1</td><td style="text-align: center;">↘</td></tr> <tr><td>8:</td><td>*10.8</td><td style="text-align: center;">↗</td></tr> <tr><td>9:</td><td>10.1</td><td style="text-align: center;">→</td></tr> <tr><td>10:</td><td>10.4</td><td style="text-align: center;">↖</td></tr> </table> | 1: | 10.3 | ↗ | 2: | 10.3 | ↗ | 3: | *10.6 | ↗ | 4: | 9.9 | ← | 5: | 10.0 | ← | 6: | 10.4 | ← | 7: | 10.1 | ↘ | 8: | *10.8 | ↗ | 9: | 10.1 | → | 10: | 10.4 | ↖ |
| 1: | 10.3 | ↗ | | | | | | | | | | | | | | | | | | | | | | | | | | | | | |
| 2: | 10.3 | ↗ | | | | | | | | | | | | | | | | | | | | | | | | | | | | | |
| 3: | *10.6 | ↗ | | | | | | | | | | | | | | | | | | | | | | | | | | | | | |
| 4: | 9.9 | ← | | | | | | | | | | | | | | | | | | | | | | | | | | | | | |
| 5: | 10.0 | ← | | | | | | | | | | | | | | | | | | | | | | | | | | | | | |
| 6: | 10.4 | ← | | | | | | | | | | | | | | | | | | | | | | | | | | | | | |
| 7: | 10.1 | ↘ | | | | | | | | | | | | | | | | | | | | | | | | | | | | | |
| 8: | *10.8 | ↗ | | | | | | | | | | | | | | | | | | | | | | | | | | | | | |
| 9: | 10.1 | → | | | | | | | | | | | | | | | | | | | | | | | | | | | | | |
| 10: | 10.4 | ↖ | | | | | | | | | | | | | | | | | | | | | | | | | | | | | |
| | <table border="1" style="width:100%; border-collapse: collapse;"> <tr> <td style="width:80%;">Serie</td> <td style="text-align: right;">99.0</td> </tr> <tr> <td>Total</td> <td style="text-align: right;">99.0</td> </tr> </table> | Serie | 99.0 | Total | 99.0 | | | | | | | | | | | | | | | | | | | | | | | | | | |
| Serie | 99.0 | | | | | | | | | | | | | | | | | | | | | | | | | | | | | | |
| Total | 99.0 | | | | | | | | | | | | | | | | | | | | | | | | | | | | | | |

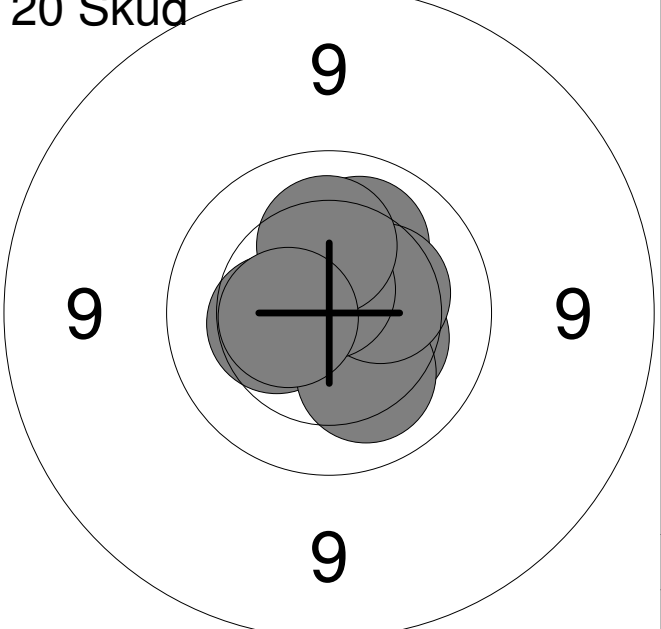
| | | | | | | | | | | | | | | | | | | | | | | | | | | | | | | | |
|--|--|-------|-------|-------|-------|------|---|-----|------|---|-----|-------|---|-----|------|---|-----|------|---|-----|------|---|-----|-------|---|-----|------|---|-----|-------|---|
| <p>20 Skud</p>  | <table style="width:100%; border-collapse: collapse;"> <tr><td style="width:10%;">11:</td><td style="width:15%;">*10.7</td><td style="width:10%; text-align: center;">↗</td></tr> <tr><td>12:</td><td>10.3</td><td style="text-align: center;">→</td></tr> <tr><td>13:</td><td>10.2</td><td style="text-align: center;">↗</td></tr> <tr><td>14:</td><td>*10.9</td><td style="text-align: center;">↖</td></tr> <tr><td>15:</td><td>10.4</td><td style="text-align: center;">←</td></tr> <tr><td>16:</td><td>10.2</td><td style="text-align: center;">↘</td></tr> <tr><td>17:</td><td>10.4</td><td style="text-align: center;">↗</td></tr> <tr><td>18:</td><td>*10.7</td><td style="text-align: center;">↗</td></tr> <tr><td>19:</td><td>10.2</td><td style="text-align: center;">↗</td></tr> <tr><td>20:</td><td>*10.5</td><td style="text-align: center;">←</td></tr> </table> | 11: | *10.7 | ↗ | 12: | 10.3 | → | 13: | 10.2 | ↗ | 14: | *10.9 | ↖ | 15: | 10.4 | ← | 16: | 10.2 | ↘ | 17: | 10.4 | ↗ | 18: | *10.7 | ↗ | 19: | 10.2 | ↗ | 20: | *10.5 | ← |
| 11: | *10.7 | ↗ | | | | | | | | | | | | | | | | | | | | | | | | | | | | | |
| 12: | 10.3 | → | | | | | | | | | | | | | | | | | | | | | | | | | | | | | |
| 13: | 10.2 | ↗ | | | | | | | | | | | | | | | | | | | | | | | | | | | | | |
| 14: | *10.9 | ↖ | | | | | | | | | | | | | | | | | | | | | | | | | | | | | |
| 15: | 10.4 | ← | | | | | | | | | | | | | | | | | | | | | | | | | | | | | |
| 16: | 10.2 | ↘ | | | | | | | | | | | | | | | | | | | | | | | | | | | | | |
| 17: | 10.4 | ↗ | | | | | | | | | | | | | | | | | | | | | | | | | | | | | |
| 18: | *10.7 | ↗ | | | | | | | | | | | | | | | | | | | | | | | | | | | | | |
| 19: | 10.2 | ↗ | | | | | | | | | | | | | | | | | | | | | | | | | | | | | |
| 20: | *10.5 | ← | | | | | | | | | | | | | | | | | | | | | | | | | | | | | |
| | <table border="1" style="width:100%; border-collapse: collapse;"> <tr> <td style="width:80%;">Serie</td> <td style="text-align: right;">100.0</td> </tr> <tr> <td>Total</td> <td style="text-align: right;">199.0</td> </tr> </table> | Serie | 100.0 | Total | 199.0 | | | | | | | | | | | | | | | | | | | | | | | | | | |
| Serie | 100.0 | | | | | | | | | | | | | | | | | | | | | | | | | | | | | | |
| Total | 199.0 | | | | | | | | | | | | | | | | | | | | | | | | | | | | | | |

| | | | | | | | | | | | | | | | | | | | | | | | | | | | | | | | | | | |
|---------------------|---|------|------|---|----|------|---|----|-------|---|----|-------|---|----|------|---|----|-------|---|----|------|---|----|-------|---|-------|--|--|-------|--|------|-------|--|-----|
| <p>Prøve</p> | <table style="width:100%; border-collapse: collapse;"> <tr><td style="width:10%;">1:</td><td style="width:40%;">10.0</td><td style="width:50%; text-align: right;">←</td></tr> <tr><td>2:</td><td>10.3</td><td style="text-align: right;">↑</td></tr> <tr><td>3:</td><td>*10.9</td><td style="text-align: right;">↗</td></tr> <tr><td>4:</td><td>*10.8</td><td style="text-align: right;">→</td></tr> <tr><td>5:</td><td>10.3</td><td style="text-align: right;">↓</td></tr> <tr><td>6:</td><td>*10.6</td><td style="text-align: right;">←</td></tr> <tr><td>7:</td><td>10.2</td><td style="text-align: right;">↑</td></tr> <tr><td>8:</td><td>*10.8</td><td style="text-align: right;">↘</td></tr> <tr><td colspan="3"><hr/></td></tr> <tr><td colspan="2">Serie</td><td style="text-align: right;">80.0</td></tr> <tr><td colspan="2">Total</td><td style="text-align: right;">0.0</td></tr> </table> | 1: | 10.0 | ← | 2: | 10.3 | ↑ | 3: | *10.9 | ↗ | 4: | *10.8 | → | 5: | 10.3 | ↓ | 6: | *10.6 | ← | 7: | 10.2 | ↑ | 8: | *10.8 | ↘ | <hr/> | | | Serie | | 80.0 | Total | | 0.0 |
| 1: | 10.0 | ← | | | | | | | | | | | | | | | | | | | | | | | | | | | | | | | | |
| 2: | 10.3 | ↑ | | | | | | | | | | | | | | | | | | | | | | | | | | | | | | | | |
| 3: | *10.9 | ↗ | | | | | | | | | | | | | | | | | | | | | | | | | | | | | | | | |
| 4: | *10.8 | → | | | | | | | | | | | | | | | | | | | | | | | | | | | | | | | | |
| 5: | 10.3 | ↓ | | | | | | | | | | | | | | | | | | | | | | | | | | | | | | | | |
| 6: | *10.6 | ← | | | | | | | | | | | | | | | | | | | | | | | | | | | | | | | | |
| 7: | 10.2 | ↑ | | | | | | | | | | | | | | | | | | | | | | | | | | | | | | | | |
| 8: | *10.8 | ↘ | | | | | | | | | | | | | | | | | | | | | | | | | | | | | | | | |
| <hr/> | | | | | | | | | | | | | | | | | | | | | | | | | | | | | | | | | | |
| Serie | | 80.0 | | | | | | | | | | | | | | | | | | | | | | | | | | | | | | | | |
| Total | | 0.0 | | | | | | | | | | | | | | | | | | | | | | | | | | | | | | | | |

| | | | | | | | | | | | | | | | | | | | | | | | | | | | | | | | | | | | | | | | | |
|-----------------------|--|------|-------|---|----|-------|---|----|------|---|----|------|---|----|-------|---|----|-----|---|----|-------|---|----|------|---|----|------|---|-----|------|---|-------|--|--|-------|--|------|-------|--|------|
| <p>20 Skud</p> | <table style="width:100%; border-collapse: collapse;"> <tr><td style="width:10%;">1:</td><td style="width:40%;">*10.8</td><td style="width:50%; text-align: right;">↘</td></tr> <tr><td>2:</td><td>*10.9</td><td style="text-align: right;">→</td></tr> <tr><td>3:</td><td>10.5</td><td style="text-align: right;">↗</td></tr> <tr><td>4:</td><td>10.4</td><td style="text-align: right;">→</td></tr> <tr><td>5:</td><td>*10.6</td><td style="text-align: right;">↘</td></tr> <tr><td>6:</td><td>9.9</td><td style="text-align: right;">↓</td></tr> <tr><td>7:</td><td>*10.6</td><td style="text-align: right;">↗</td></tr> <tr><td>8:</td><td>10.1</td><td style="text-align: right;">↘</td></tr> <tr><td>9:</td><td>10.4</td><td style="text-align: right;">↘</td></tr> <tr><td>10:</td><td>10.3</td><td style="text-align: right;">↓</td></tr> <tr><td colspan="3"><hr/></td></tr> <tr><td colspan="2">Serie</td><td style="text-align: right;">99.0</td></tr> <tr><td colspan="2">Total</td><td style="text-align: right;">99.0</td></tr> </table> | 1: | *10.8 | ↘ | 2: | *10.9 | → | 3: | 10.5 | ↗ | 4: | 10.4 | → | 5: | *10.6 | ↘ | 6: | 9.9 | ↓ | 7: | *10.6 | ↗ | 8: | 10.1 | ↘ | 9: | 10.4 | ↘ | 10: | 10.3 | ↓ | <hr/> | | | Serie | | 99.0 | Total | | 99.0 |
| 1: | *10.8 | ↘ | | | | | | | | | | | | | | | | | | | | | | | | | | | | | | | | | | | | | | |
| 2: | *10.9 | → | | | | | | | | | | | | | | | | | | | | | | | | | | | | | | | | | | | | | | |
| 3: | 10.5 | ↗ | | | | | | | | | | | | | | | | | | | | | | | | | | | | | | | | | | | | | | |
| 4: | 10.4 | → | | | | | | | | | | | | | | | | | | | | | | | | | | | | | | | | | | | | | | |
| 5: | *10.6 | ↘ | | | | | | | | | | | | | | | | | | | | | | | | | | | | | | | | | | | | | | |
| 6: | 9.9 | ↓ | | | | | | | | | | | | | | | | | | | | | | | | | | | | | | | | | | | | | | |
| 7: | *10.6 | ↗ | | | | | | | | | | | | | | | | | | | | | | | | | | | | | | | | | | | | | | |
| 8: | 10.1 | ↘ | | | | | | | | | | | | | | | | | | | | | | | | | | | | | | | | | | | | | | |
| 9: | 10.4 | ↘ | | | | | | | | | | | | | | | | | | | | | | | | | | | | | | | | | | | | | | |
| 10: | 10.3 | ↓ | | | | | | | | | | | | | | | | | | | | | | | | | | | | | | | | | | | | | | |
| <hr/> | | | | | | | | | | | | | | | | | | | | | | | | | | | | | | | | | | | | | | | | |
| Serie | | 99.0 | | | | | | | | | | | | | | | | | | | | | | | | | | | | | | | | | | | | | | |
| Total | | 99.0 | | | | | | | | | | | | | | | | | | | | | | | | | | | | | | | | | | | | | | |

| | | | | | | | | | | | | | | | | | | | | | | | | | | | | | | | | | | | | | | | | |
|-----------------------|--|-------|-------|---|-----|-------|---|-----|-------|---|-----|-------|---|-----|-------|---|-----|------|---|-----|------|---|-----|------|---|-----|-------|---|-----|------|---|-------|--|--|-------|--|-------|-------|--|-------|
| <p>20 Skud</p> | <table style="width:100%; border-collapse: collapse;"> <tr><td style="width:10%;">11:</td><td style="width:40%;">*10.7</td><td style="width:50%; text-align: right;">←</td></tr> <tr><td>12:</td><td>*10.6</td><td style="text-align: right;">←</td></tr> <tr><td>13:</td><td>*10.8</td><td style="text-align: right;">↘</td></tr> <tr><td>14:</td><td>*10.7</td><td style="text-align: right;">↘</td></tr> <tr><td>15:</td><td>*10.6</td><td style="text-align: right;">↘</td></tr> <tr><td>16:</td><td>10.4</td><td style="text-align: right;">←</td></tr> <tr><td>17:</td><td>10.5</td><td style="text-align: right;">↗</td></tr> <tr><td>18:</td><td>10.0</td><td style="text-align: right;">←</td></tr> <tr><td>19:</td><td>*10.8</td><td style="text-align: right;">↘</td></tr> <tr><td>20:</td><td>10.5</td><td style="text-align: right;">↑</td></tr> <tr><td colspan="3"><hr/></td></tr> <tr><td colspan="2">Serie</td><td style="text-align: right;">100.0</td></tr> <tr><td colspan="2">Total</td><td style="text-align: right;">199.0</td></tr> </table> | 11: | *10.7 | ← | 12: | *10.6 | ← | 13: | *10.8 | ↘ | 14: | *10.7 | ↘ | 15: | *10.6 | ↘ | 16: | 10.4 | ← | 17: | 10.5 | ↗ | 18: | 10.0 | ← | 19: | *10.8 | ↘ | 20: | 10.5 | ↑ | <hr/> | | | Serie | | 100.0 | Total | | 199.0 |
| 11: | *10.7 | ← | | | | | | | | | | | | | | | | | | | | | | | | | | | | | | | | | | | | | | |
| 12: | *10.6 | ← | | | | | | | | | | | | | | | | | | | | | | | | | | | | | | | | | | | | | | |
| 13: | *10.8 | ↘ | | | | | | | | | | | | | | | | | | | | | | | | | | | | | | | | | | | | | | |
| 14: | *10.7 | ↘ | | | | | | | | | | | | | | | | | | | | | | | | | | | | | | | | | | | | | | |
| 15: | *10.6 | ↘ | | | | | | | | | | | | | | | | | | | | | | | | | | | | | | | | | | | | | | |
| 16: | 10.4 | ← | | | | | | | | | | | | | | | | | | | | | | | | | | | | | | | | | | | | | | |
| 17: | 10.5 | ↗ | | | | | | | | | | | | | | | | | | | | | | | | | | | | | | | | | | | | | | |
| 18: | 10.0 | ← | | | | | | | | | | | | | | | | | | | | | | | | | | | | | | | | | | | | | | |
| 19: | *10.8 | ↘ | | | | | | | | | | | | | | | | | | | | | | | | | | | | | | | | | | | | | | |
| 20: | 10.5 | ↑ | | | | | | | | | | | | | | | | | | | | | | | | | | | | | | | | | | | | | | |
| <hr/> | | | | | | | | | | | | | | | | | | | | | | | | | | | | | | | | | | | | | | | | |
| Serie | | 100.0 | | | | | | | | | | | | | | | | | | | | | | | | | | | | | | | | | | | | | | |
| Total | | 199.0 | | | | | | | | | | | | | | | | | | | | | | | | | | | | | | | | | | | | | | |

Hold
26

Skive
7

Rasmus Mikkelsen

Vadum Skf.

MB2

Prøve

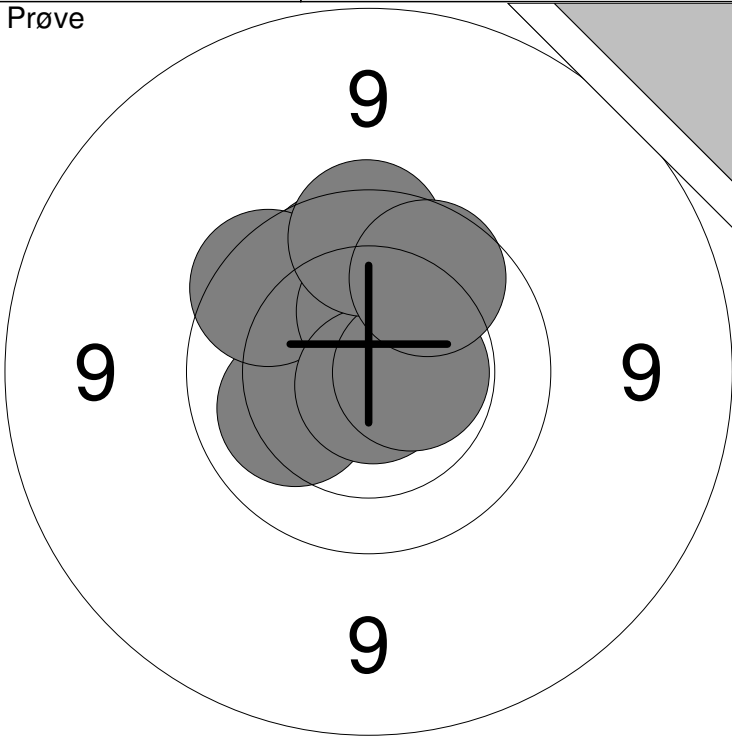

Prøve

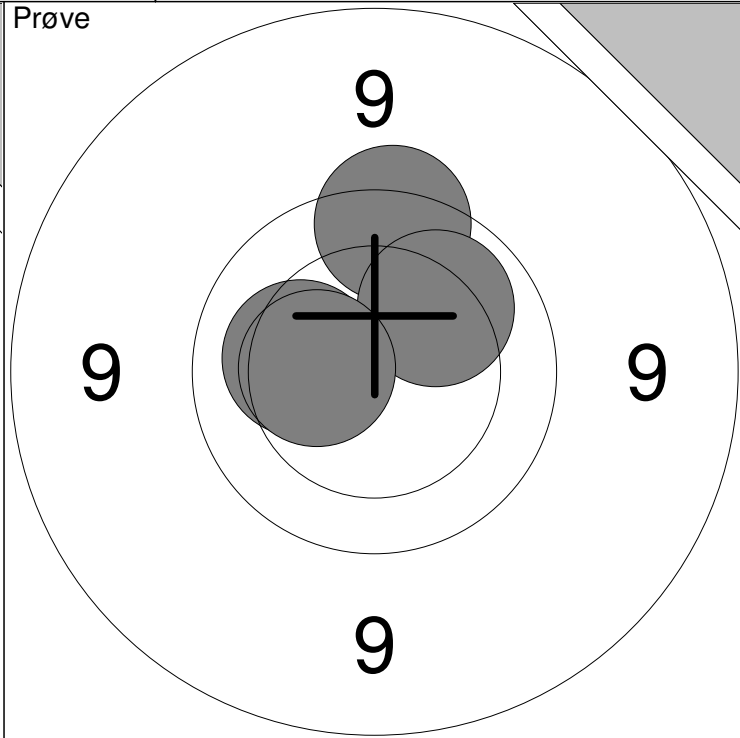

| | |
|------------|------------|
| 1: 10.2 ↙ | 6: 10.4 ↑ |
| 2: 9.9 ↑ | 7: *10.8 ↓ |
| 3: 9.8 ↖ | 8: *10.5 → |
| 4: *10.6 ↗ | 9: 9.8 ↑ |
| 5: 10.2 ↑ | 10: 9.9 ↗ |

| | |
|-------|------|
| Serie | 96.0 |
| Total | 0.0 |

| | |
|------------|------------|
| 11: 10.2 ← | 12: 9.7 ↑ |
| 13: 10.1 ↗ | 14: 10.4 ← |

| | |
|-------|------|
| Serie | 39.0 |
| Total | 0.0 |

20 Skud

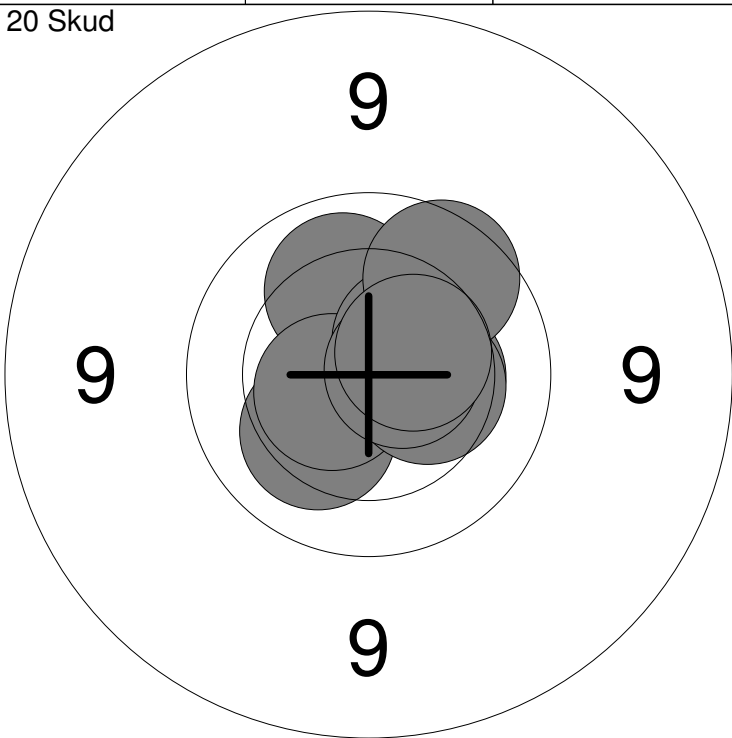

20 Skud

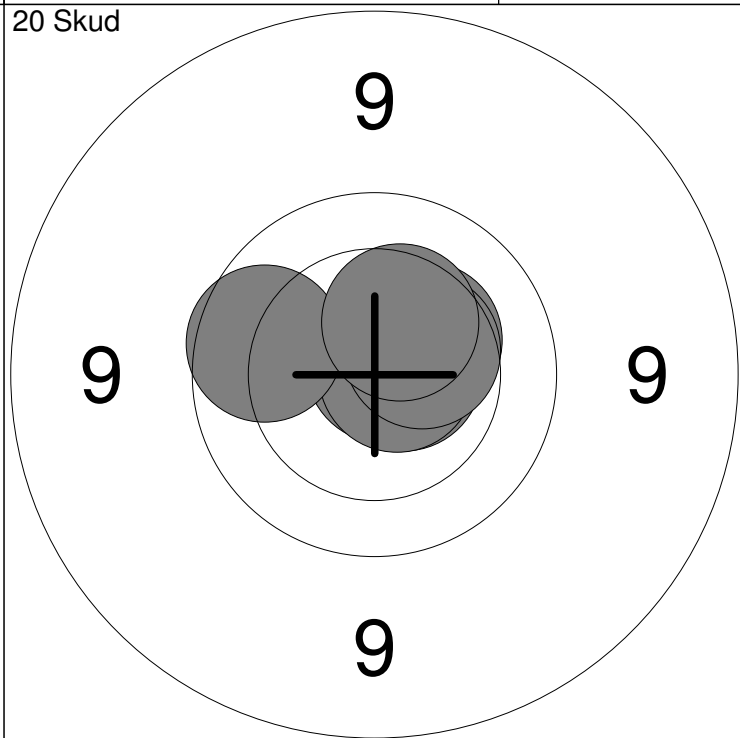

| | |
|------------|------------|
| 1: *10.7 ↙ | 6: 10.4 → |
| 2: 10.2 ↙ | 7: 10.4 ↗ |
| 3: 10.4 → | 8: *10.6 → |
| 4: 10.1 ↑ | 9: 9.9 ↗ |
| 5: *10.6 ↙ | 10: 10.5 ↗ |

| | |
|-------|------|
| Serie | 99.0 |
| Total | 99.0 |

| | |
|-------------|-------------|
| 11: *10.7 ↗ | 16: *10.5 ↗ |
| 12: *10.7 → | 17: *10.7 → |
| 13: 10.4 ↗ | 18: 10.4 ↗ |
| 14: *10.6 ↑ | 19: 9.9 ← |
| 15: *10.8 ↗ | 20: 10.4 ↑ |

| | |
|-------|-------|
| Serie | 99.0 |
| Total | 198.0 |

| | | | | | | | | | | | | | | | | | | | | | | | | | | | | | | | | | | | | | |
|-----------------------|---|-------|------|---|-----|------|---|-----|-------|---|-----|------|---|-----|------|---|-----|------|---|-----|-------|---|-------|------|------|-------|-------|-----|-----|------|---|-------|--|------|-------|--|-------|
| <p>Prøve</p> | <table style="width:100%; border-collapse: collapse;"> <tr><td style="width:10%;">1:</td><td style="width:15%;">10.0</td><td style="width:10%; text-align: center;">→</td></tr> <tr><td>2:</td><td>10.4</td><td style="text-align: center;">←</td></tr> <tr><td>3:</td><td>10.5</td><td style="text-align: center;">↘</td></tr> <tr><td>4:</td><td>10.5</td><td style="text-align: center;">↗</td></tr> <tr><td>5:</td><td>10.0</td><td style="text-align: center;">↗</td></tr> <tr><td>6:</td><td>10.3</td><td style="text-align: center;">←</td></tr> <tr><td>7:</td><td>*10.6</td><td style="text-align: center;">↘</td></tr> <tr><td colspan="2">Serie</td><td style="text-align: right;">70.0</td></tr> <tr><td colspan="2">Total</td><td style="text-align: right;">0.0</td></tr> </table> | 1: | 10.0 | → | 2: | 10.4 | ← | 3: | 10.5 | ↘ | 4: | 10.5 | ↗ | 5: | 10.0 | ↗ | 6: | 10.3 | ← | 7: | *10.6 | ↘ | Serie | | 70.0 | Total | | 0.0 | | | | | | | | | |
| 1: | 10.0 | → | | | | | | | | | | | | | | | | | | | | | | | | | | | | | | | | | | | |
| 2: | 10.4 | ← | | | | | | | | | | | | | | | | | | | | | | | | | | | | | | | | | | | |
| 3: | 10.5 | ↘ | | | | | | | | | | | | | | | | | | | | | | | | | | | | | | | | | | | |
| 4: | 10.5 | ↗ | | | | | | | | | | | | | | | | | | | | | | | | | | | | | | | | | | | |
| 5: | 10.0 | ↗ | | | | | | | | | | | | | | | | | | | | | | | | | | | | | | | | | | | |
| 6: | 10.3 | ← | | | | | | | | | | | | | | | | | | | | | | | | | | | | | | | | | | | |
| 7: | *10.6 | ↘ | | | | | | | | | | | | | | | | | | | | | | | | | | | | | | | | | | | |
| Serie | | 70.0 | | | | | | | | | | | | | | | | | | | | | | | | | | | | | | | | | | | |
| Total | | 0.0 | | | | | | | | | | | | | | | | | | | | | | | | | | | | | | | | | | | |
| <p>20 Skud</p> | <table style="width:100%; border-collapse: collapse;"> <tr><td style="width:10%;">1:</td><td style="width:15%;">10.5</td><td style="width:10%; text-align: center;">↘</td></tr> <tr><td>2:</td><td>10.2</td><td style="text-align: center;">↑</td></tr> <tr><td>3:</td><td>*10.9</td><td style="text-align: center;">↗</td></tr> <tr><td>4:</td><td>10.0</td><td style="text-align: center;">↖</td></tr> <tr><td>5:</td><td>10.0</td><td style="text-align: center;">←</td></tr> <tr><td>6:</td><td>10.4</td><td style="text-align: center;">↗</td></tr> <tr><td>7:</td><td>10.3</td><td style="text-align: center;">←</td></tr> <tr><td>8:</td><td>9.6</td><td style="text-align: center;">↗</td></tr> <tr><td>9:</td><td>10.3</td><td style="text-align: center;">↘</td></tr> <tr><td>10:</td><td>10.1</td><td style="text-align: center;">→</td></tr> <tr><td colspan="2">Serie</td><td style="text-align: right;">99.0</td></tr> <tr><td colspan="2">Total</td><td style="text-align: right;">99.0</td></tr> </table> | 1: | 10.5 | ↘ | 2: | 10.2 | ↑ | 3: | *10.9 | ↗ | 4: | 10.0 | ↖ | 5: | 10.0 | ← | 6: | 10.4 | ↗ | 7: | 10.3 | ← | 8: | 9.6 | ↗ | 9: | 10.3 | ↘ | 10: | 10.1 | → | Serie | | 99.0 | Total | | 99.0 |
| 1: | 10.5 | ↘ | | | | | | | | | | | | | | | | | | | | | | | | | | | | | | | | | | | |
| 2: | 10.2 | ↑ | | | | | | | | | | | | | | | | | | | | | | | | | | | | | | | | | | | |
| 3: | *10.9 | ↗ | | | | | | | | | | | | | | | | | | | | | | | | | | | | | | | | | | | |
| 4: | 10.0 | ↖ | | | | | | | | | | | | | | | | | | | | | | | | | | | | | | | | | | | |
| 5: | 10.0 | ← | | | | | | | | | | | | | | | | | | | | | | | | | | | | | | | | | | | |
| 6: | 10.4 | ↗ | | | | | | | | | | | | | | | | | | | | | | | | | | | | | | | | | | | |
| 7: | 10.3 | ← | | | | | | | | | | | | | | | | | | | | | | | | | | | | | | | | | | | |
| 8: | 9.6 | ↗ | | | | | | | | | | | | | | | | | | | | | | | | | | | | | | | | | | | |
| 9: | 10.3 | ↘ | | | | | | | | | | | | | | | | | | | | | | | | | | | | | | | | | | | |
| 10: | 10.1 | → | | | | | | | | | | | | | | | | | | | | | | | | | | | | | | | | | | | |
| Serie | | 99.0 | | | | | | | | | | | | | | | | | | | | | | | | | | | | | | | | | | | |
| Total | | 99.0 | | | | | | | | | | | | | | | | | | | | | | | | | | | | | | | | | | | |
| <p>20 Skud</p> | <table style="width:100%; border-collapse: collapse;"> <tr><td style="width:10%;">11:</td><td style="width:15%;">10.3</td><td style="width:10%; text-align: center;">→</td></tr> <tr><td>12:</td><td>10.1</td><td style="text-align: center;">→</td></tr> <tr><td>13:</td><td>10.5</td><td style="text-align: center;">←</td></tr> <tr><td>14:</td><td>10.3</td><td style="text-align: center;">→</td></tr> <tr><td>15:</td><td>10.5</td><td style="text-align: center;">↗</td></tr> <tr><td>16:</td><td>9.9</td><td style="text-align: center;">↑</td></tr> <tr><td>17:</td><td>10.4</td><td style="text-align: center;">←</td></tr> <tr><td>18:</td><td>10.2</td><td style="text-align: center;">↗</td></tr> <tr><td>19:</td><td>*10.8</td><td style="text-align: center;">→</td></tr> <tr><td>20:</td><td>10.1</td><td style="text-align: center;">←</td></tr> <tr><td colspan="2">Serie</td><td style="text-align: right;">99.0</td></tr> <tr><td colspan="2">Total</td><td style="text-align: right;">198.0</td></tr> </table> | 11: | 10.3 | → | 12: | 10.1 | → | 13: | 10.5 | ← | 14: | 10.3 | → | 15: | 10.5 | ↗ | 16: | 9.9 | ↑ | 17: | 10.4 | ← | 18: | 10.2 | ↗ | 19: | *10.8 | → | 20: | 10.1 | ← | Serie | | 99.0 | Total | | 198.0 |
| 11: | 10.3 | → | | | | | | | | | | | | | | | | | | | | | | | | | | | | | | | | | | | |
| 12: | 10.1 | → | | | | | | | | | | | | | | | | | | | | | | | | | | | | | | | | | | | |
| 13: | 10.5 | ← | | | | | | | | | | | | | | | | | | | | | | | | | | | | | | | | | | | |
| 14: | 10.3 | → | | | | | | | | | | | | | | | | | | | | | | | | | | | | | | | | | | | |
| 15: | 10.5 | ↗ | | | | | | | | | | | | | | | | | | | | | | | | | | | | | | | | | | | |
| 16: | 9.9 | ↑ | | | | | | | | | | | | | | | | | | | | | | | | | | | | | | | | | | | |
| 17: | 10.4 | ← | | | | | | | | | | | | | | | | | | | | | | | | | | | | | | | | | | | |
| 18: | 10.2 | ↗ | | | | | | | | | | | | | | | | | | | | | | | | | | | | | | | | | | | |
| 19: | *10.8 | → | | | | | | | | | | | | | | | | | | | | | | | | | | | | | | | | | | | |
| 20: | 10.1 | ← | | | | | | | | | | | | | | | | | | | | | | | | | | | | | | | | | | | |
| Serie | | 99.0 | | | | | | | | | | | | | | | | | | | | | | | | | | | | | | | | | | | |
| Total | | 198.0 | | | | | | | | | | | | | | | | | | | | | | | | | | | | | | | | | | | |

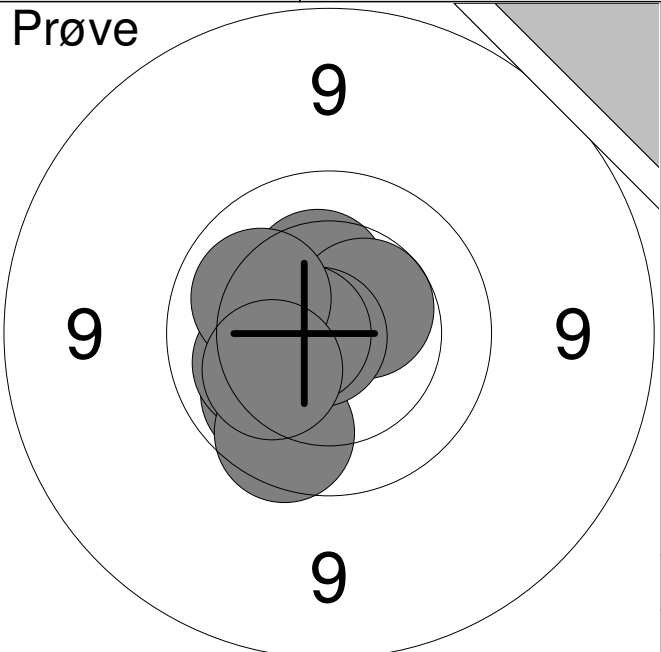
| | | | | | | | | | | | | | | | | | | | | | | | | | | | | | | | | | | |
|--|---|-------------|------|---|----|------|---|----|------|---|----|-----|---|----|------|---|----|-------|---|----|-------|---|----|------|---|----|------|---|--------------|--|-------------|--------------|--|------------|
| <p>Prøve</p>  | <table style="width:100%; border-collapse: collapse;"> <tr><td>1:</td><td>10.4</td><td>↑</td></tr> <tr><td>2:</td><td>10.0</td><td>↙</td></tr> <tr><td>3:</td><td>10.2</td><td>↙</td></tr> <tr><td>4:</td><td>9.9</td><td>↘</td></tr> <tr><td>5:</td><td>10.5</td><td>↗</td></tr> <tr><td>6:</td><td>*10.8</td><td>↙</td></tr> <tr><td>7:</td><td>*10.6</td><td>↙</td></tr> <tr><td>8:</td><td>10.1</td><td>↗</td></tr> <tr><td>9:</td><td>10.2</td><td>↙</td></tr> <tr><td colspan="2">Serie</td><td>89.0</td></tr> <tr><td colspan="2">Total</td><td>0.0</td></tr> </table> | 1: | 10.4 | ↑ | 2: | 10.0 | ↙ | 3: | 10.2 | ↙ | 4: | 9.9 | ↘ | 5: | 10.5 | ↗ | 6: | *10.8 | ↙ | 7: | *10.6 | ↙ | 8: | 10.1 | ↗ | 9: | 10.2 | ↙ | Serie | | 89.0 | Total | | 0.0 |
| 1: | 10.4 | ↑ | | | | | | | | | | | | | | | | | | | | | | | | | | | | | | | | |
| 2: | 10.0 | ↙ | | | | | | | | | | | | | | | | | | | | | | | | | | | | | | | | |
| 3: | 10.2 | ↙ | | | | | | | | | | | | | | | | | | | | | | | | | | | | | | | | |
| 4: | 9.9 | ↘ | | | | | | | | | | | | | | | | | | | | | | | | | | | | | | | | |
| 5: | 10.5 | ↗ | | | | | | | | | | | | | | | | | | | | | | | | | | | | | | | | |
| 6: | *10.8 | ↙ | | | | | | | | | | | | | | | | | | | | | | | | | | | | | | | | |
| 7: | *10.6 | ↙ | | | | | | | | | | | | | | | | | | | | | | | | | | | | | | | | |
| 8: | 10.1 | ↗ | | | | | | | | | | | | | | | | | | | | | | | | | | | | | | | | |
| 9: | 10.2 | ↙ | | | | | | | | | | | | | | | | | | | | | | | | | | | | | | | | |
| Serie | | 89.0 | | | | | | | | | | | | | | | | | | | | | | | | | | | | | | | | |
| Total | | 0.0 | | | | | | | | | | | | | | | | | | | | | | | | | | | | | | | | |

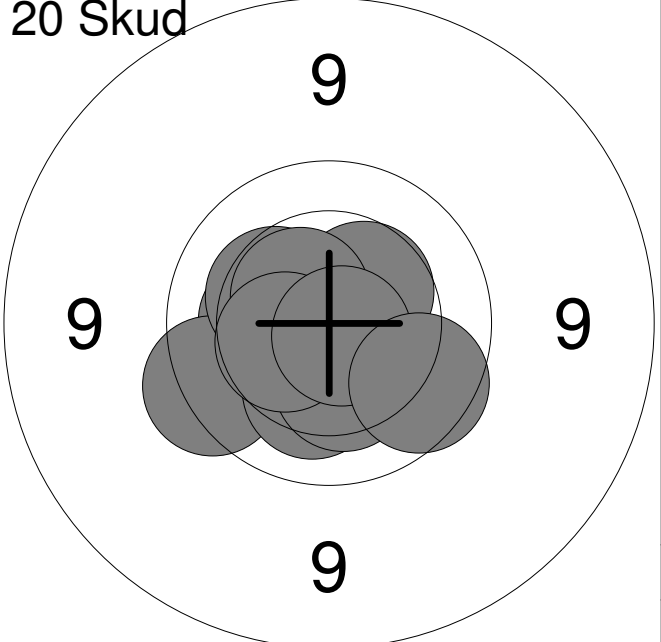
| | | | | | | | | | | | | | | | | | | | | | | | | | | | | | | | | | | | | | |
|---|--|-------------|------|---|----|------|---|----|-----|---|----|------|---|----|------|---|----|------|---|----|-------|---|----|------|---|----|-------|---|-----|-----|---|--------------|--|-------------|--------------|--|-------------|
| <p>20 Skud</p>  | <table style="width:100%; border-collapse: collapse;"> <tr><td>1:</td><td>10.3</td><td>←</td></tr> <tr><td>2:</td><td>10.4</td><td>↗</td></tr> <tr><td>3:</td><td>9.7</td><td>↙</td></tr> <tr><td>4:</td><td>10.2</td><td>↘</td></tr> <tr><td>5:</td><td>10.3</td><td>↗</td></tr> <tr><td>6:</td><td>10.3</td><td>↘</td></tr> <tr><td>7:</td><td>*10.5</td><td>↗</td></tr> <tr><td>8:</td><td>10.4</td><td>↙</td></tr> <tr><td>9:</td><td>*10.8</td><td>↘</td></tr> <tr><td>10:</td><td>9.9</td><td>↘</td></tr> <tr><td colspan="2">Serie</td><td>98.0</td></tr> <tr><td colspan="2">Total</td><td>98.0</td></tr> </table> | 1: | 10.3 | ← | 2: | 10.4 | ↗ | 3: | 9.7 | ↙ | 4: | 10.2 | ↘ | 5: | 10.3 | ↗ | 6: | 10.3 | ↘ | 7: | *10.5 | ↗ | 8: | 10.4 | ↙ | 9: | *10.8 | ↘ | 10: | 9.9 | ↘ | Serie | | 98.0 | Total | | 98.0 |
| 1: | 10.3 | ← | | | | | | | | | | | | | | | | | | | | | | | | | | | | | | | | | | | |
| 2: | 10.4 | ↗ | | | | | | | | | | | | | | | | | | | | | | | | | | | | | | | | | | | |
| 3: | 9.7 | ↙ | | | | | | | | | | | | | | | | | | | | | | | | | | | | | | | | | | | |
| 4: | 10.2 | ↘ | | | | | | | | | | | | | | | | | | | | | | | | | | | | | | | | | | | |
| 5: | 10.3 | ↗ | | | | | | | | | | | | | | | | | | | | | | | | | | | | | | | | | | | |
| 6: | 10.3 | ↘ | | | | | | | | | | | | | | | | | | | | | | | | | | | | | | | | | | | |
| 7: | *10.5 | ↗ | | | | | | | | | | | | | | | | | | | | | | | | | | | | | | | | | | | |
| 8: | 10.4 | ↙ | | | | | | | | | | | | | | | | | | | | | | | | | | | | | | | | | | | |
| 9: | *10.8 | ↘ | | | | | | | | | | | | | | | | | | | | | | | | | | | | | | | | | | | |
| 10: | 9.9 | ↘ | | | | | | | | | | | | | | | | | | | | | | | | | | | | | | | | | | | |
| Serie | | 98.0 | | | | | | | | | | | | | | | | | | | | | | | | | | | | | | | | | | | |
| Total | | 98.0 | | | | | | | | | | | | | | | | | | | | | | | | | | | | | | | | | | | |

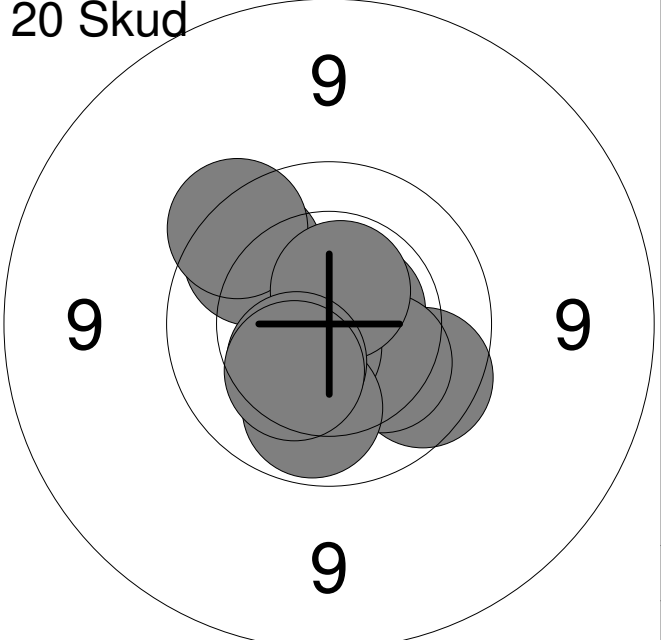
| | | | | | | | | | | | | | | | | | | | | | | | | | | | | | | | | | | | | | |
|--|--|--------------|-------|---|-----|-----|---|-----|------|---|-----|-------|---|-----|-----|---|-----|-----|---|-----|------|---|-----|-------|---|-----|------|---|-----|------|---|--------------|--|-------------|--------------|--|--------------|
| <p>20 Skud</p>  | <table style="width:100%; border-collapse: collapse;"> <tr><td>11:</td><td>*10.6</td><td>↗</td></tr> <tr><td>12:</td><td>9.9</td><td>↘</td></tr> <tr><td>13:</td><td>10.2</td><td>↘</td></tr> <tr><td>14:</td><td>*10.6</td><td>↙</td></tr> <tr><td>15:</td><td>9.9</td><td>↗</td></tr> <tr><td>16:</td><td>9.7</td><td>↗</td></tr> <tr><td>17:</td><td>10.0</td><td>↘</td></tr> <tr><td>18:</td><td>*10.6</td><td>↗</td></tr> <tr><td>19:</td><td>10.4</td><td>↙</td></tr> <tr><td>20:</td><td>10.3</td><td>↙</td></tr> <tr><td colspan="2">Serie</td><td>97.0</td></tr> <tr><td colspan="2">Total</td><td>195.0</td></tr> </table> | 11: | *10.6 | ↗ | 12: | 9.9 | ↘ | 13: | 10.2 | ↘ | 14: | *10.6 | ↙ | 15: | 9.9 | ↗ | 16: | 9.7 | ↗ | 17: | 10.0 | ↘ | 18: | *10.6 | ↗ | 19: | 10.4 | ↙ | 20: | 10.3 | ↙ | Serie | | 97.0 | Total | | 195.0 |
| 11: | *10.6 | ↗ | | | | | | | | | | | | | | | | | | | | | | | | | | | | | | | | | | | |
| 12: | 9.9 | ↘ | | | | | | | | | | | | | | | | | | | | | | | | | | | | | | | | | | | |
| 13: | 10.2 | ↘ | | | | | | | | | | | | | | | | | | | | | | | | | | | | | | | | | | | |
| 14: | *10.6 | ↙ | | | | | | | | | | | | | | | | | | | | | | | | | | | | | | | | | | | |
| 15: | 9.9 | ↗ | | | | | | | | | | | | | | | | | | | | | | | | | | | | | | | | | | | |
| 16: | 9.7 | ↗ | | | | | | | | | | | | | | | | | | | | | | | | | | | | | | | | | | | |
| 17: | 10.0 | ↘ | | | | | | | | | | | | | | | | | | | | | | | | | | | | | | | | | | | |
| 18: | *10.6 | ↗ | | | | | | | | | | | | | | | | | | | | | | | | | | | | | | | | | | | |
| 19: | 10.4 | ↙ | | | | | | | | | | | | | | | | | | | | | | | | | | | | | | | | | | | |
| 20: | 10.3 | ↙ | | | | | | | | | | | | | | | | | | | | | | | | | | | | | | | | | | | |
| Serie | | 97.0 | | | | | | | | | | | | | | | | | | | | | | | | | | | | | | | | | | | |
| Total | | 195.0 | | | | | | | | | | | | | | | | | | | | | | | | | | | | | | | | | | | |

Hold
26

Skive
10

Emil Myrup Langgaard

Løgstør Skyttelaug

MB1

Prøve

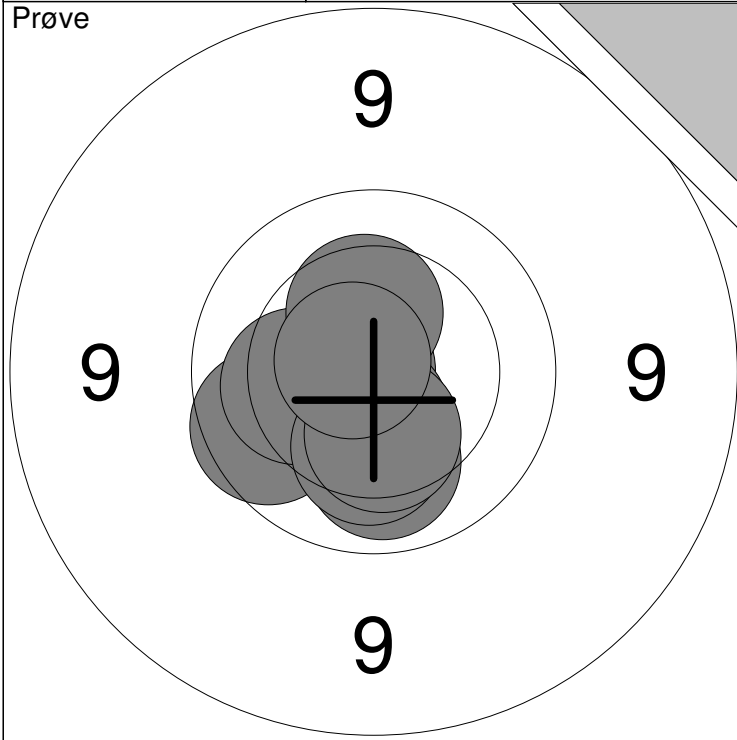

Prøve

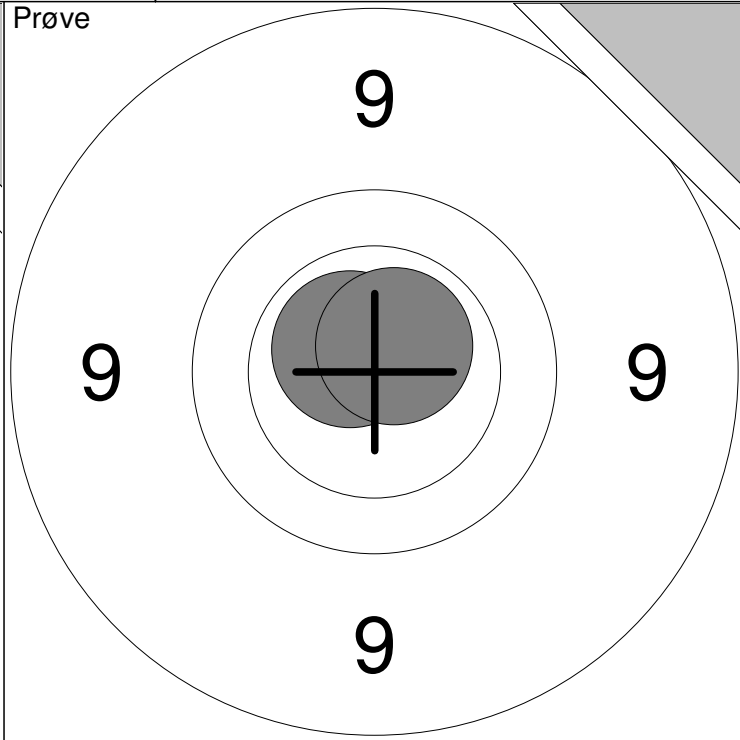

1: 10.1 ↓
 2: *10.8 ←
 3: *10.5 ↓
 4: 10.3 ↓
 5: 9.9 ←

6: 10.2 ←
 7: 10.4 ↑
 8: 10.2 ↓
 9: 10.3 ↓
 10: *10.7 ←

Serie 99.0
 Total 0.0

11: *10.6 ↖
 12: *10.6 ↗

Serie 20.0
 Total 0.0

20 Skud

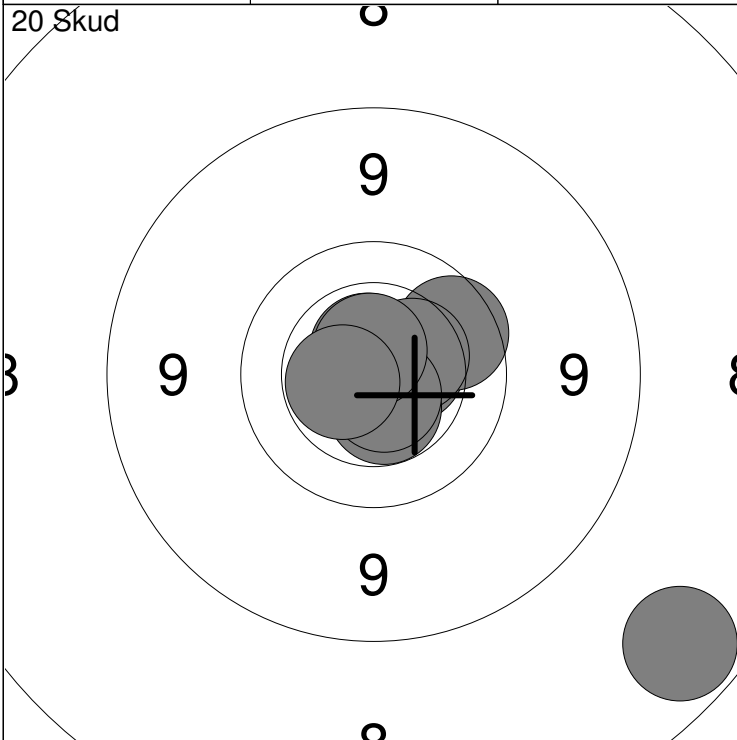

20 Skud

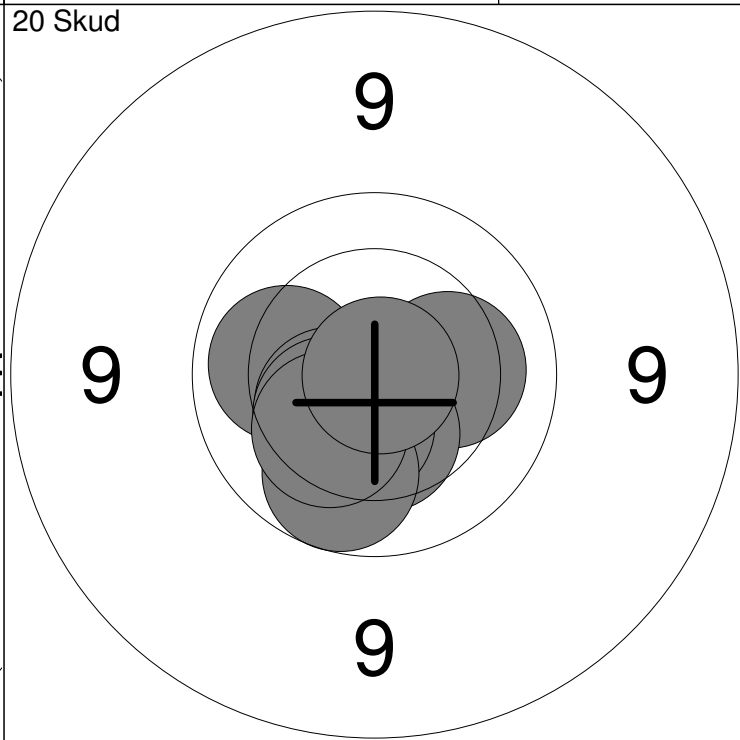

1: *10.5 →
 2: 8.0 ↓
 3: *10.6 ↑
 4: *10.8 ←
 5: 9.9 →

6: 10.4 →
 7: *10.5 ↓
 8: *10.6 ↓
 9: *10.6 ↑
 10: *10.5 ←

Serie 97.0
 Total 97.0

11: 10.2 →
 12: *10.7 ↓
 13: 10.4 ↓
 14: 10.4 ↓
 15: 10.1 ←

16: 9.9 ↓
 17: 10.4 ←
 18: 10.4 ←
 19: 10.3 ↓
 20: *10.9 →

Serie 99.0
 Total 196.0

| | | | | | | | | | | | | | | | | | | | | | | |
|---------------------|--|----|-----|---|----|------|---|----|-----|---|----|-------|---|----|-------|---|----|------|---|----|-------|---|
| <p>Prøve</p> | <table style="width:100%; border-collapse: collapse;"> <tr><td>1:</td><td>9.0</td><td>↙</td></tr> <tr><td>2:</td><td>10.4</td><td>↓</td></tr> <tr><td>3:</td><td>9.9</td><td>↘</td></tr> <tr><td>4:</td><td>*10.6</td><td>↑</td></tr> <tr><td>5:</td><td>*10.5</td><td>↓</td></tr> <tr><td>6:</td><td>10.2</td><td>↗</td></tr> <tr><td>7:</td><td>*10.6</td><td>↗</td></tr> </table> | 1: | 9.0 | ↙ | 2: | 10.4 | ↓ | 3: | 9.9 | ↘ | 4: | *10.6 | ↑ | 5: | *10.5 | ↓ | 6: | 10.2 | ↗ | 7: | *10.6 | ↗ |
| 1: | 9.0 | ↙ | | | | | | | | | | | | | | | | | | | | |
| 2: | 10.4 | ↓ | | | | | | | | | | | | | | | | | | | | |
| 3: | 9.9 | ↘ | | | | | | | | | | | | | | | | | | | | |
| 4: | *10.6 | ↑ | | | | | | | | | | | | | | | | | | | | |
| 5: | *10.5 | ↓ | | | | | | | | | | | | | | | | | | | | |
| 6: | 10.2 | ↗ | | | | | | | | | | | | | | | | | | | | |
| 7: | *10.6 | ↗ | | | | | | | | | | | | | | | | | | | | |
| | Serie 68.0 | | | | | | | | | | | | | | | | | | | | | |
| | Total 0.0 | | | | | | | | | | | | | | | | | | | | | |

| | | | | | | | | | | | | | | | | | | | | | | | | | | | | | | | |
|-----------------------|--|----|-----|---|----|------|---|----|-----|---|----|-------|---|----|------|---|----|------|---|----|-----|---|----|------|---|----|------|---|-----|------|---|
| <p>20 Skud</p> | <table style="width:100%; border-collapse: collapse;"> <tr><td>1:</td><td>9.9</td><td>↗</td></tr> <tr><td>2:</td><td>10.1</td><td>↗</td></tr> <tr><td>3:</td><td>9.9</td><td>↙</td></tr> <tr><td>4:</td><td>*10.7</td><td>↗</td></tr> <tr><td>5:</td><td>10.3</td><td>↗</td></tr> <tr><td>6:</td><td>10.4</td><td>↗</td></tr> <tr><td>7:</td><td>9.9</td><td>↗</td></tr> <tr><td>8:</td><td>10.5</td><td>↗</td></tr> <tr><td>9:</td><td>10.4</td><td>↗</td></tr> <tr><td>10:</td><td>10.2</td><td>↓</td></tr> </table> | 1: | 9.9 | ↗ | 2: | 10.1 | ↗ | 3: | 9.9 | ↙ | 4: | *10.7 | ↗ | 5: | 10.3 | ↗ | 6: | 10.4 | ↗ | 7: | 9.9 | ↗ | 8: | 10.5 | ↗ | 9: | 10.4 | ↗ | 10: | 10.2 | ↓ |
| 1: | 9.9 | ↗ | | | | | | | | | | | | | | | | | | | | | | | | | | | | | |
| 2: | 10.1 | ↗ | | | | | | | | | | | | | | | | | | | | | | | | | | | | | |
| 3: | 9.9 | ↙ | | | | | | | | | | | | | | | | | | | | | | | | | | | | | |
| 4: | *10.7 | ↗ | | | | | | | | | | | | | | | | | | | | | | | | | | | | | |
| 5: | 10.3 | ↗ | | | | | | | | | | | | | | | | | | | | | | | | | | | | | |
| 6: | 10.4 | ↗ | | | | | | | | | | | | | | | | | | | | | | | | | | | | | |
| 7: | 9.9 | ↗ | | | | | | | | | | | | | | | | | | | | | | | | | | | | | |
| 8: | 10.5 | ↗ | | | | | | | | | | | | | | | | | | | | | | | | | | | | | |
| 9: | 10.4 | ↗ | | | | | | | | | | | | | | | | | | | | | | | | | | | | | |
| 10: | 10.2 | ↓ | | | | | | | | | | | | | | | | | | | | | | | | | | | | | |
| | Serie 97.0 | | | | | | | | | | | | | | | | | | | | | | | | | | | | | | |
| | Total 97.0 | | | | | | | | | | | | | | | | | | | | | | | | | | | | | | |

| | | | | | | | | | | | | | | | | | | | | | | | | | | | | | | | |
|-----------------------|--|-----|------|---|-----|------|---|-----|------|---|-----|-------|---|-----|-------|---|-----|------|---|-----|-----|---|-----|------|---|-----|------|---|-----|------|---|
| <p>20 Skud</p> | <table style="width:100%; border-collapse: collapse;"> <tr><td>11:</td><td>10.4</td><td>↓</td></tr> <tr><td>12:</td><td>10.4</td><td>↓</td></tr> <tr><td>13:</td><td>10.1</td><td>↓</td></tr> <tr><td>14:</td><td>*10.6</td><td>↗</td></tr> <tr><td>15:</td><td>*10.6</td><td>↙</td></tr> <tr><td>16:</td><td>10.3</td><td>↓</td></tr> <tr><td>17:</td><td>9.8</td><td>↗</td></tr> <tr><td>18:</td><td>10.3</td><td>↑</td></tr> <tr><td>19:</td><td>10.3</td><td>↗</td></tr> <tr><td>20:</td><td>10.3</td><td>↗</td></tr> </table> | 11: | 10.4 | ↓ | 12: | 10.4 | ↓ | 13: | 10.1 | ↓ | 14: | *10.6 | ↗ | 15: | *10.6 | ↙ | 16: | 10.3 | ↓ | 17: | 9.8 | ↗ | 18: | 10.3 | ↑ | 19: | 10.3 | ↗ | 20: | 10.3 | ↗ |
| 11: | 10.4 | ↓ | | | | | | | | | | | | | | | | | | | | | | | | | | | | | |
| 12: | 10.4 | ↓ | | | | | | | | | | | | | | | | | | | | | | | | | | | | | |
| 13: | 10.1 | ↓ | | | | | | | | | | | | | | | | | | | | | | | | | | | | | |
| 14: | *10.6 | ↗ | | | | | | | | | | | | | | | | | | | | | | | | | | | | | |
| 15: | *10.6 | ↙ | | | | | | | | | | | | | | | | | | | | | | | | | | | | | |
| 16: | 10.3 | ↓ | | | | | | | | | | | | | | | | | | | | | | | | | | | | | |
| 17: | 9.8 | ↗ | | | | | | | | | | | | | | | | | | | | | | | | | | | | | |
| 18: | 10.3 | ↑ | | | | | | | | | | | | | | | | | | | | | | | | | | | | | |
| 19: | 10.3 | ↗ | | | | | | | | | | | | | | | | | | | | | | | | | | | | | |
| 20: | 10.3 | ↗ | | | | | | | | | | | | | | | | | | | | | | | | | | | | | |
| | Serie 99.0 | | | | | | | | | | | | | | | | | | | | | | | | | | | | | | |
| | Total 196.0 | | | | | | | | | | | | | | | | | | | | | | | | | | | | | | |

Hold
26

Skive
12

Mikkel Bertelsen

Vadum Skf.

MJ1

Prøve

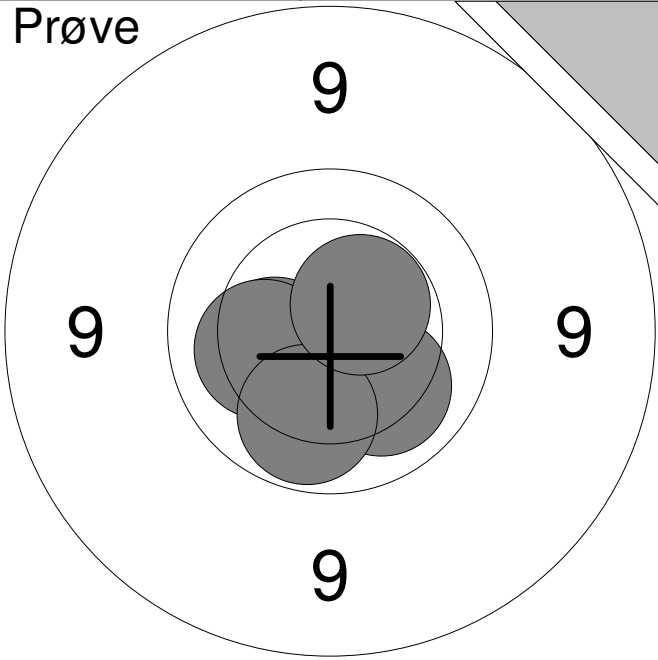

| | | |
|----|-------|---|
| 1: | 10.3 | ← |
| 2: | 10.2 | ← |
| 3: | 10.1 | ↘ |
| 4: | 10.0 | ↘ |
| 5: | *10.5 | ↗ |

| | |
|-------|------|
| Serie | 50.0 |
| Total | 0.0 |

20 Skud

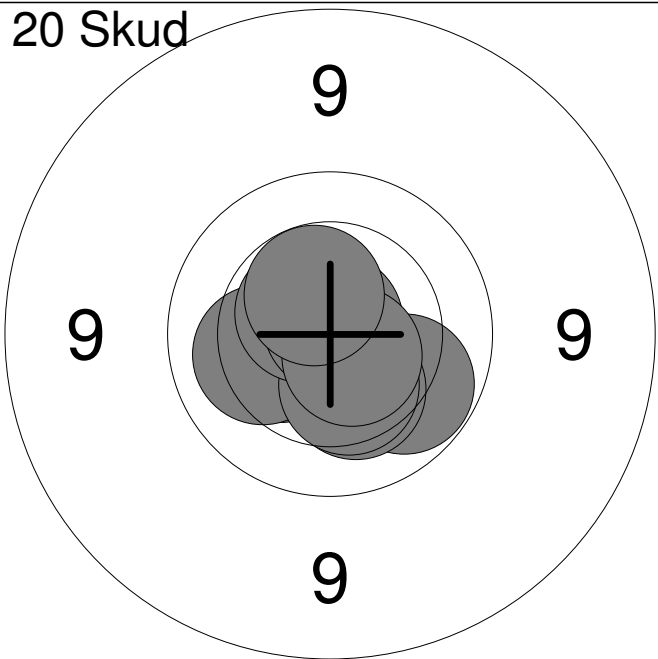

| | | |
|-----|-------|---|
| 1: | 10.0 | ↘ |
| 2: | 10.4 | ← |
| 3: | 10.2 | ← |
| 4: | 10.3 | ↘ |
| 5: | *10.8 | ↗ |
| 6: | 10.4 | ↘ |
| 7: | *10.6 | ↗ |
| 8: | *10.8 | ↗ |
| 9: | *10.6 | ↘ |
| 10: | *10.5 | ↗ |

| | |
|-------|-------|
| Serie | 100.0 |
| Total | 100.0 |

20 Skud

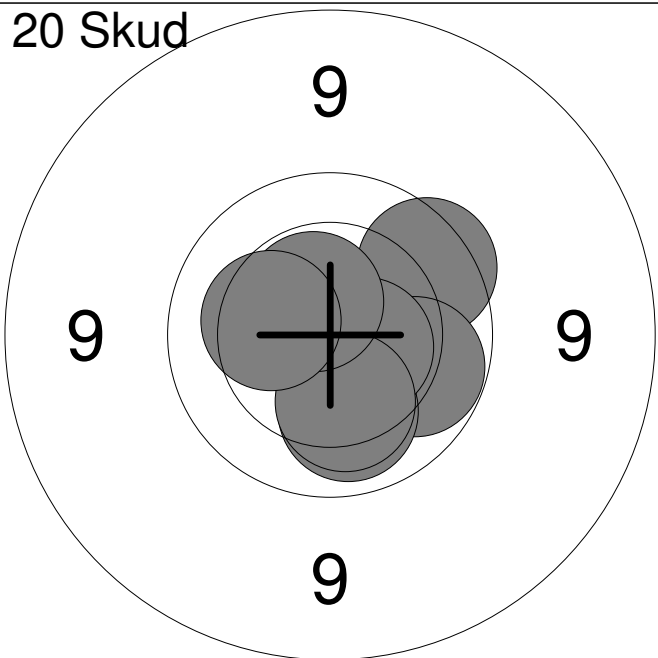

| | | |
|-----|-------|---|
| 11: | *10.5 | → |
| 12: | *10.8 | → |
| 13: | 9.8 | ↗ |
| 14: | 10.0 | ↘ |
| 15: | 10.1 | ↘ |
| 16: | *10.6 | ↘ |
| 17: | *10.5 | ↗ |
| 18: | 10.2 | ↘ |
| 19: | *10.6 | ↗ |
| 20: | 10.3 | ← |

| | |
|-------|-------|
| Serie | 99.0 |
| Total | 199.0 |

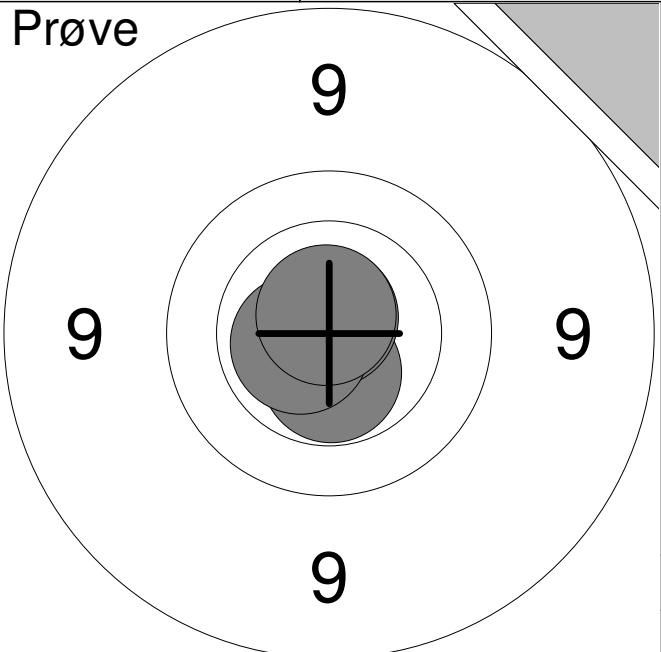
| | | | | | | | | | | | | | | | | | | | | | | | | | |
|--|---|------|-------|---|----|-------|---|----|-------|---|----|-------|---|----|-------|---|-------|--|--|-------|--|------|-------|--|-----|
| <p>Prøve</p>  | <table style="width:100%; border-collapse: collapse;"> <tr><td style="width:10%;">1:</td><td style="width:15%;">*10.8</td><td style="width:10%; text-align: right;">←</td></tr> <tr><td>2:</td><td>*10.5</td><td style="text-align: right;">↓</td></tr> <tr><td>3:</td><td>*10.8</td><td style="text-align: right;">↑</td></tr> <tr><td>4:</td><td>*10.6</td><td style="text-align: right;">←</td></tr> <tr><td>5:</td><td>*10.8</td><td style="text-align: right;">↑</td></tr> <tr><td colspan="3"><hr/></td></tr> <tr><td colspan="2">Serie</td><td style="text-align: right;">50.0</td></tr> <tr><td colspan="2">Total</td><td style="text-align: right;">0.0</td></tr> </table> | 1: | *10.8 | ← | 2: | *10.5 | ↓ | 3: | *10.8 | ↑ | 4: | *10.6 | ← | 5: | *10.8 | ↑ | <hr/> | | | Serie | | 50.0 | Total | | 0.0 |
| 1: | *10.8 | ← | | | | | | | | | | | | | | | | | | | | | | | |
| 2: | *10.5 | ↓ | | | | | | | | | | | | | | | | | | | | | | | |
| 3: | *10.8 | ↑ | | | | | | | | | | | | | | | | | | | | | | | |
| 4: | *10.6 | ← | | | | | | | | | | | | | | | | | | | | | | | |
| 5: | *10.8 | ↑ | | | | | | | | | | | | | | | | | | | | | | | |
| <hr/> | | | | | | | | | | | | | | | | | | | | | | | | | |
| Serie | | 50.0 | | | | | | | | | | | | | | | | | | | | | | | |
| Total | | 0.0 | | | | | | | | | | | | | | | | | | | | | | | |

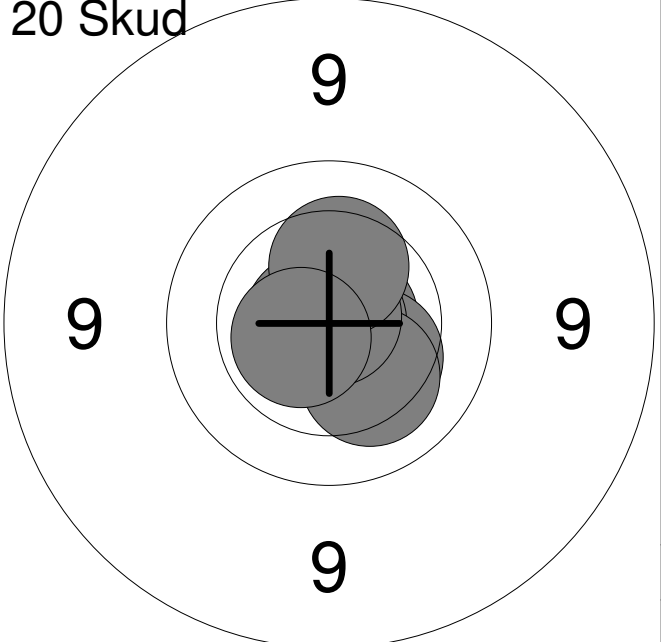
| | | | | | | | | | | | | | | | | | | | | | | | | | | | | | | | | | | | | | | | | |
|---|--|-------|-------|---|----|-------|---|----|-------|---|----|------|---|----|-------|---|----|------|---|----|-------|---|----|-------|---|----|------|---|-----|-------|---|-------|--|--|-------|--|-------|-------|--|-------|
| <p>20 Skud</p>  | <table style="width:100%; border-collapse: collapse;"> <tr><td style="width:10%;">1:</td><td style="width:15%;">*10.8</td><td style="width:10%; text-align: right;">→</td></tr> <tr><td>2:</td><td>*10.8</td><td style="text-align: right;">↓</td></tr> <tr><td>3:</td><td>*10.7</td><td style="text-align: right;">→</td></tr> <tr><td>4:</td><td>10.4</td><td style="text-align: right;">↓</td></tr> <tr><td>5:</td><td>*10.9</td><td style="text-align: right;">→</td></tr> <tr><td>6:</td><td>10.2</td><td style="text-align: right;">↓</td></tr> <tr><td>7:</td><td>*10.8</td><td style="text-align: right;">←</td></tr> <tr><td>8:</td><td>*10.9</td><td style="text-align: right;">↑</td></tr> <tr><td>9:</td><td>10.3</td><td style="text-align: right;">↑</td></tr> <tr><td>10:</td><td>*10.6</td><td style="text-align: right;">←</td></tr> <tr><td colspan="3"><hr/></td></tr> <tr><td colspan="2">Serie</td><td style="text-align: right;">100.0</td></tr> <tr><td colspan="2">Total</td><td style="text-align: right;">100.0</td></tr> </table> | 1: | *10.8 | → | 2: | *10.8 | ↓ | 3: | *10.7 | → | 4: | 10.4 | ↓ | 5: | *10.9 | → | 6: | 10.2 | ↓ | 7: | *10.8 | ← | 8: | *10.9 | ↑ | 9: | 10.3 | ↑ | 10: | *10.6 | ← | <hr/> | | | Serie | | 100.0 | Total | | 100.0 |
| 1: | *10.8 | → | | | | | | | | | | | | | | | | | | | | | | | | | | | | | | | | | | | | | | |
| 2: | *10.8 | ↓ | | | | | | | | | | | | | | | | | | | | | | | | | | | | | | | | | | | | | | |
| 3: | *10.7 | → | | | | | | | | | | | | | | | | | | | | | | | | | | | | | | | | | | | | | | |
| 4: | 10.4 | ↓ | | | | | | | | | | | | | | | | | | | | | | | | | | | | | | | | | | | | | | |
| 5: | *10.9 | → | | | | | | | | | | | | | | | | | | | | | | | | | | | | | | | | | | | | | | |
| 6: | 10.2 | ↓ | | | | | | | | | | | | | | | | | | | | | | | | | | | | | | | | | | | | | | |
| 7: | *10.8 | ← | | | | | | | | | | | | | | | | | | | | | | | | | | | | | | | | | | | | | | |
| 8: | *10.9 | ↑ | | | | | | | | | | | | | | | | | | | | | | | | | | | | | | | | | | | | | | |
| 9: | 10.3 | ↑ | | | | | | | | | | | | | | | | | | | | | | | | | | | | | | | | | | | | | | |
| 10: | *10.6 | ← | | | | | | | | | | | | | | | | | | | | | | | | | | | | | | | | | | | | | | |
| <hr/> | | | | | | | | | | | | | | | | | | | | | | | | | | | | | | | | | | | | | | | | |
| Serie | | 100.0 | | | | | | | | | | | | | | | | | | | | | | | | | | | | | | | | | | | | | | |
| Total | | 100.0 | | | | | | | | | | | | | | | | | | | | | | | | | | | | | | | | | | | | | | |

| | | | | | | | | | | | | | | | | | | | | | | | | | | | | | | | | | | | | | | | | |
|--|---|-------|-------|---|-----|-------|---|-----|------|---|-----|-------|---|-----|-------|---|-----|-------|---|-----|------|---|-----|------|---|-----|-------|---|-----|-------|---|-------|--|--|-------|--|-------|-------|--|-------|
| <p>20 Skud</p>  | <table style="width:100%; border-collapse: collapse;"> <tr><td style="width:10%;">11:</td><td style="width:15%;">*10.6</td><td style="width:10%; text-align: right;">↑</td></tr> <tr><td>12:</td><td>*10.7</td><td style="text-align: right;">←</td></tr> <tr><td>13:</td><td>10.4</td><td style="text-align: right;">↗</td></tr> <tr><td>14:</td><td>*10.7</td><td style="text-align: right;">←</td></tr> <tr><td>15:</td><td>*10.8</td><td style="text-align: right;">←</td></tr> <tr><td>16:</td><td>*10.8</td><td style="text-align: right;">←</td></tr> <tr><td>17:</td><td>10.4</td><td style="text-align: right;">↗</td></tr> <tr><td>18:</td><td>10.1</td><td style="text-align: right;">←</td></tr> <tr><td>19:</td><td>*10.8</td><td style="text-align: right;">↑</td></tr> <tr><td>20:</td><td>*10.5</td><td style="text-align: right;">↙</td></tr> <tr><td colspan="3"><hr/></td></tr> <tr><td colspan="2">Serie</td><td style="text-align: right;">100.0</td></tr> <tr><td colspan="2">Total</td><td style="text-align: right;">200.0</td></tr> </table> | 11: | *10.6 | ↑ | 12: | *10.7 | ← | 13: | 10.4 | ↗ | 14: | *10.7 | ← | 15: | *10.8 | ← | 16: | *10.8 | ← | 17: | 10.4 | ↗ | 18: | 10.1 | ← | 19: | *10.8 | ↑ | 20: | *10.5 | ↙ | <hr/> | | | Serie | | 100.0 | Total | | 200.0 |
| 11: | *10.6 | ↑ | | | | | | | | | | | | | | | | | | | | | | | | | | | | | | | | | | | | | | |
| 12: | *10.7 | ← | | | | | | | | | | | | | | | | | | | | | | | | | | | | | | | | | | | | | | |
| 13: | 10.4 | ↗ | | | | | | | | | | | | | | | | | | | | | | | | | | | | | | | | | | | | | | |
| 14: | *10.7 | ← | | | | | | | | | | | | | | | | | | | | | | | | | | | | | | | | | | | | | | |
| 15: | *10.8 | ← | | | | | | | | | | | | | | | | | | | | | | | | | | | | | | | | | | | | | | |
| 16: | *10.8 | ← | | | | | | | | | | | | | | | | | | | | | | | | | | | | | | | | | | | | | | |
| 17: | 10.4 | ↗ | | | | | | | | | | | | | | | | | | | | | | | | | | | | | | | | | | | | | | |
| 18: | 10.1 | ← | | | | | | | | | | | | | | | | | | | | | | | | | | | | | | | | | | | | | | |
| 19: | *10.8 | ↑ | | | | | | | | | | | | | | | | | | | | | | | | | | | | | | | | | | | | | | |
| 20: | *10.5 | ↙ | | | | | | | | | | | | | | | | | | | | | | | | | | | | | | | | | | | | | | |
| <hr/> | | | | | | | | | | | | | | | | | | | | | | | | | | | | | | | | | | | | | | | | |
| Serie | | 100.0 | | | | | | | | | | | | | | | | | | | | | | | | | | | | | | | | | | | | | | |
| Total | | 200.0 | | | | | | | | | | | | | | | | | | | | | | | | | | | | | | | | | | | | | | |

| | | | | | | | | | | | | | | | | | | | | | | |
|---|--|-------|------|-------|-----|-----|---|----|------|---|----|-----|---|----|------|---|----|-----|---|----|------|---|
| <p>Prøve</p> | <table style="width:100%; border-collapse: collapse;"> <tr><td>1:</td><td>10.1</td><td>↙</td></tr> <tr><td>2:</td><td>9.8</td><td>↙</td></tr> <tr><td>3:</td><td>10.1</td><td>↑</td></tr> <tr><td>4:</td><td>9.9</td><td>↗</td></tr> <tr><td>5:</td><td>10.1</td><td>↗</td></tr> <tr><td>6:</td><td>9.9</td><td>↙</td></tr> <tr><td>7:</td><td>10.0</td><td>↑</td></tr> </table> | 1: | 10.1 | ↙ | 2: | 9.8 | ↙ | 3: | 10.1 | ↑ | 4: | 9.9 | ↗ | 5: | 10.1 | ↗ | 6: | 9.9 | ↙ | 7: | 10.0 | ↑ |
| 1: | 10.1 | ↙ | | | | | | | | | | | | | | | | | | | | |
| 2: | 9.8 | ↙ | | | | | | | | | | | | | | | | | | | | |
| 3: | 10.1 | ↑ | | | | | | | | | | | | | | | | | | | | |
| 4: | 9.9 | ↗ | | | | | | | | | | | | | | | | | | | | |
| 5: | 10.1 | ↗ | | | | | | | | | | | | | | | | | | | | |
| 6: | 9.9 | ↙ | | | | | | | | | | | | | | | | | | | | |
| 7: | 10.0 | ↑ | | | | | | | | | | | | | | | | | | | | |
| <table style="width:100%; border-collapse: collapse;"> <tr> <td style="width:80%;">Serie</td> <td style="text-align: right;">67.0</td> </tr> <tr> <td>Total</td> <td style="text-align: right;">0.0</td> </tr> </table> | | Serie | 67.0 | Total | 0.0 | | | | | | | | | | | | | | | | | |
| Serie | 67.0 | | | | | | | | | | | | | | | | | | | | | |
| Total | 0.0 | | | | | | | | | | | | | | | | | | | | | |

| | | | | | | | | | | | | | | | | | | | | | | | | | | | | | | | |
|--|---|-------|------|-------|------|-----|---|----|-------|---|----|-----|---|----|------|---|----|------|---|----|-----|---|----|------|---|----|-------|---|-----|------|---|
| <p>20 Skud</p> | <table style="width:100%; border-collapse: collapse;"> <tr><td>1:</td><td>10.0</td><td>→</td></tr> <tr><td>2:</td><td>9.9</td><td>↗</td></tr> <tr><td>3:</td><td>*10.5</td><td>↑</td></tr> <tr><td>4:</td><td>9.9</td><td>←</td></tr> <tr><td>5:</td><td>10.3</td><td>↙</td></tr> <tr><td>6:</td><td>10.4</td><td>↙</td></tr> <tr><td>7:</td><td>9.9</td><td>→</td></tr> <tr><td>8:</td><td>10.0</td><td>↑</td></tr> <tr><td>9:</td><td>*10.5</td><td>↗</td></tr> <tr><td>10:</td><td>10.1</td><td>←</td></tr> </table> | 1: | 10.0 | → | 2: | 9.9 | ↗ | 3: | *10.5 | ↑ | 4: | 9.9 | ← | 5: | 10.3 | ↙ | 6: | 10.4 | ↙ | 7: | 9.9 | → | 8: | 10.0 | ↑ | 9: | *10.5 | ↗ | 10: | 10.1 | ← |
| 1: | 10.0 | → | | | | | | | | | | | | | | | | | | | | | | | | | | | | | |
| 2: | 9.9 | ↗ | | | | | | | | | | | | | | | | | | | | | | | | | | | | | |
| 3: | *10.5 | ↑ | | | | | | | | | | | | | | | | | | | | | | | | | | | | | |
| 4: | 9.9 | ← | | | | | | | | | | | | | | | | | | | | | | | | | | | | | |
| 5: | 10.3 | ↙ | | | | | | | | | | | | | | | | | | | | | | | | | | | | | |
| 6: | 10.4 | ↙ | | | | | | | | | | | | | | | | | | | | | | | | | | | | | |
| 7: | 9.9 | → | | | | | | | | | | | | | | | | | | | | | | | | | | | | | |
| 8: | 10.0 | ↑ | | | | | | | | | | | | | | | | | | | | | | | | | | | | | |
| 9: | *10.5 | ↗ | | | | | | | | | | | | | | | | | | | | | | | | | | | | | |
| 10: | 10.1 | ← | | | | | | | | | | | | | | | | | | | | | | | | | | | | | |
| <table style="width:100%; border-collapse: collapse;"> <tr> <td style="width:80%;">Serie</td> <td style="text-align: right;">97.0</td> </tr> <tr> <td>Total</td> <td style="text-align: right;">97.0</td> </tr> </table> | | Serie | 97.0 | Total | 97.0 | | | | | | | | | | | | | | | | | | | | | | | | | | |
| Serie | 97.0 | | | | | | | | | | | | | | | | | | | | | | | | | | | | | | |
| Total | 97.0 | | | | | | | | | | | | | | | | | | | | | | | | | | | | | | |

| | | | | | | | | | | | | | | | | | | | | | | | | | | | | | | | |
|---|---|-------|------|-------|-------|-------|---|-----|-------|---|-----|------|---|-----|-----|---|-----|-----|---|-----|-----|---|-----|-------|---|-----|-----|---|-----|------|---|
| <p>20 Skud</p> | <table style="width:100%; border-collapse: collapse;"> <tr><td>11:</td><td>9.6</td><td>↗</td></tr> <tr><td>12:</td><td>*10.6</td><td>↑</td></tr> <tr><td>13:</td><td>*10.5</td><td>←</td></tr> <tr><td>14:</td><td>10.3</td><td>↙</td></tr> <tr><td>15:</td><td>9.6</td><td>↑</td></tr> <tr><td>16:</td><td>9.4</td><td>↑</td></tr> <tr><td>17:</td><td>9.5</td><td>←</td></tr> <tr><td>18:</td><td>*10.6</td><td>↗</td></tr> <tr><td>19:</td><td>9.5</td><td>↑</td></tr> <tr><td>20:</td><td>10.2</td><td>←</td></tr> </table> | 11: | 9.6 | ↗ | 12: | *10.6 | ↑ | 13: | *10.5 | ← | 14: | 10.3 | ↙ | 15: | 9.6 | ↑ | 16: | 9.4 | ↑ | 17: | 9.5 | ← | 18: | *10.6 | ↗ | 19: | 9.5 | ↑ | 20: | 10.2 | ← |
| 11: | 9.6 | ↗ | | | | | | | | | | | | | | | | | | | | | | | | | | | | | |
| 12: | *10.6 | ↑ | | | | | | | | | | | | | | | | | | | | | | | | | | | | | |
| 13: | *10.5 | ← | | | | | | | | | | | | | | | | | | | | | | | | | | | | | |
| 14: | 10.3 | ↙ | | | | | | | | | | | | | | | | | | | | | | | | | | | | | |
| 15: | 9.6 | ↑ | | | | | | | | | | | | | | | | | | | | | | | | | | | | | |
| 16: | 9.4 | ↑ | | | | | | | | | | | | | | | | | | | | | | | | | | | | | |
| 17: | 9.5 | ← | | | | | | | | | | | | | | | | | | | | | | | | | | | | | |
| 18: | *10.6 | ↗ | | | | | | | | | | | | | | | | | | | | | | | | | | | | | |
| 19: | 9.5 | ↑ | | | | | | | | | | | | | | | | | | | | | | | | | | | | | |
| 20: | 10.2 | ← | | | | | | | | | | | | | | | | | | | | | | | | | | | | | |
| <table style="width:100%; border-collapse: collapse;"> <tr> <td style="width:80%;">Serie</td> <td style="text-align: right;">95.0</td> </tr> <tr> <td>Total</td> <td style="text-align: right;">192.0</td> </tr> </table> | | Serie | 95.0 | Total | 192.0 | | | | | | | | | | | | | | | | | | | | | | | | | | |
| Serie | 95.0 | | | | | | | | | | | | | | | | | | | | | | | | | | | | | | |
| Total | 192.0 | | | | | | | | | | | | | | | | | | | | | | | | | | | | | | |

| | | | | | | | | | | | | | | | | | | | | | | | | | |
|---------------------|---|-------|-----|------|-------|------|-----|----|------|---|----|-------|---|----|------|---|----|------|---|----|------|---|----|-------|---|
| <p>Prøve</p> | <table style="width:100%; border-collapse: collapse;"> <tr><td style="width:10%;">1:</td><td style="width:15%;">9.9</td><td style="width:10%; text-align: center;">↗</td></tr> <tr><td>2:</td><td>10.2</td><td style="text-align: center;">→</td></tr> <tr><td>3:</td><td>10.3</td><td style="text-align: center;">↗</td></tr> <tr><td>4:</td><td>*10.7</td><td style="text-align: center;">↓</td></tr> <tr><td>5:</td><td>10.1</td><td style="text-align: center;">↓</td></tr> <tr><td>6:</td><td>10.2</td><td style="text-align: center;">↙</td></tr> <tr><td>7:</td><td>10.5</td><td style="text-align: center;">←</td></tr> <tr><td>8:</td><td>*10.6</td><td style="text-align: center;">←</td></tr> </table> | 1: | 9.9 | ↗ | 2: | 10.2 | → | 3: | 10.3 | ↗ | 4: | *10.7 | ↓ | 5: | 10.1 | ↓ | 6: | 10.2 | ↙ | 7: | 10.5 | ← | 8: | *10.6 | ← |
| 1: | 9.9 | ↗ | | | | | | | | | | | | | | | | | | | | | | | |
| 2: | 10.2 | → | | | | | | | | | | | | | | | | | | | | | | | |
| 3: | 10.3 | ↗ | | | | | | | | | | | | | | | | | | | | | | | |
| 4: | *10.7 | ↓ | | | | | | | | | | | | | | | | | | | | | | | |
| 5: | 10.1 | ↓ | | | | | | | | | | | | | | | | | | | | | | | |
| 6: | 10.2 | ↙ | | | | | | | | | | | | | | | | | | | | | | | |
| 7: | 10.5 | ← | | | | | | | | | | | | | | | | | | | | | | | |
| 8: | *10.6 | ← | | | | | | | | | | | | | | | | | | | | | | | |
| | <table border="1" style="width:100%; border-collapse: collapse;"> <tr> <td style="width:10%;">Serie</td> <td style="width:15%;"></td> <td style="width:10%; text-align: right;">79.0</td> </tr> <tr> <td>Total</td> <td></td> <td style="text-align: right;">0.0</td> </tr> </table> | Serie | | 79.0 | Total | | 0.0 | | | | | | | | | | | | | | | | | | |
| Serie | | 79.0 | | | | | | | | | | | | | | | | | | | | | | | |
| Total | | 0.0 | | | | | | | | | | | | | | | | | | | | | | | |

| | | | | | | | | | | | | | | | | | | | | | | | | | | | | | | | |
|-----------------------|--|-------|-----|------|-------|------|------|----|-------|---|----|------|---|----|------|---|----|------|---|----|-------|---|----|------|---|----|-------|---|-----|-----|---|
| <p>20 Skud</p> | <table style="width:100%; border-collapse: collapse;"> <tr><td style="width:10%;">1:</td><td style="width:15%;">9.9</td><td style="width:10%; text-align: center;">↘</td></tr> <tr><td>2:</td><td>10.3</td><td style="text-align: center;">↙</td></tr> <tr><td>3:</td><td>*10.8</td><td style="text-align: center;">←</td></tr> <tr><td>4:</td><td>10.0</td><td style="text-align: center;">←</td></tr> <tr><td>5:</td><td>10.4</td><td style="text-align: center;">↗</td></tr> <tr><td>6:</td><td>10.1</td><td style="text-align: center;">↗</td></tr> <tr><td>7:</td><td>*10.5</td><td style="text-align: center;">→</td></tr> <tr><td>8:</td><td>10.4</td><td style="text-align: center;">←</td></tr> <tr><td>9:</td><td>*10.8</td><td style="text-align: center;">↗</td></tr> <tr><td>10:</td><td>9.9</td><td style="text-align: center;">↗</td></tr> </table> | 1: | 9.9 | ↘ | 2: | 10.3 | ↙ | 3: | *10.8 | ← | 4: | 10.0 | ← | 5: | 10.4 | ↗ | 6: | 10.1 | ↗ | 7: | *10.5 | → | 8: | 10.4 | ← | 9: | *10.8 | ↗ | 10: | 9.9 | ↗ |
| 1: | 9.9 | ↘ | | | | | | | | | | | | | | | | | | | | | | | | | | | | | |
| 2: | 10.3 | ↙ | | | | | | | | | | | | | | | | | | | | | | | | | | | | | |
| 3: | *10.8 | ← | | | | | | | | | | | | | | | | | | | | | | | | | | | | | |
| 4: | 10.0 | ← | | | | | | | | | | | | | | | | | | | | | | | | | | | | | |
| 5: | 10.4 | ↗ | | | | | | | | | | | | | | | | | | | | | | | | | | | | | |
| 6: | 10.1 | ↗ | | | | | | | | | | | | | | | | | | | | | | | | | | | | | |
| 7: | *10.5 | → | | | | | | | | | | | | | | | | | | | | | | | | | | | | | |
| 8: | 10.4 | ← | | | | | | | | | | | | | | | | | | | | | | | | | | | | | |
| 9: | *10.8 | ↗ | | | | | | | | | | | | | | | | | | | | | | | | | | | | | |
| 10: | 9.9 | ↗ | | | | | | | | | | | | | | | | | | | | | | | | | | | | | |
| | <table border="1" style="width:100%; border-collapse: collapse;"> <tr> <td style="width:10%;">Serie</td> <td style="width:15%;"></td> <td style="width:10%; text-align: right;">98.0</td> </tr> <tr> <td>Total</td> <td></td> <td style="text-align: right;">98.0</td> </tr> </table> | Serie | | 98.0 | Total | | 98.0 | | | | | | | | | | | | | | | | | | | | | | | | |
| Serie | | 98.0 | | | | | | | | | | | | | | | | | | | | | | | | | | | | | |
| Total | | 98.0 | | | | | | | | | | | | | | | | | | | | | | | | | | | | | |

| | | | | | | | | | | | | | | | | | | | | | | | | | | | | | | | |
|-----------------------|---|-------|-------|-------|-------|-------|-------|-----|------|---|-----|------|---|-----|------|---|-----|------|---|-----|-------|---|-----|-------|---|-----|------|---|-----|-------|---|
| <p>20 Skud</p> | <table style="width:100%; border-collapse: collapse;"> <tr><td style="width:10%;">11:</td><td style="width:15%;">*10.6</td><td style="width:10%; text-align: center;">↗</td></tr> <tr><td>12:</td><td>*10.7</td><td style="text-align: center;">↗</td></tr> <tr><td>13:</td><td>10.3</td><td style="text-align: center;">↗</td></tr> <tr><td>14:</td><td>10.1</td><td style="text-align: center;">↗</td></tr> <tr><td>15:</td><td>10.2</td><td style="text-align: center;">↗</td></tr> <tr><td>16:</td><td>10.2</td><td style="text-align: center;">↗</td></tr> <tr><td>17:</td><td>*10.5</td><td style="text-align: center;">↓</td></tr> <tr><td>18:</td><td>*10.6</td><td style="text-align: center;">↗</td></tr> <tr><td>19:</td><td>10.4</td><td style="text-align: center;">→</td></tr> <tr><td>20:</td><td>*10.6</td><td style="text-align: center;">↘</td></tr> </table> | 11: | *10.6 | ↗ | 12: | *10.7 | ↗ | 13: | 10.3 | ↗ | 14: | 10.1 | ↗ | 15: | 10.2 | ↗ | 16: | 10.2 | ↗ | 17: | *10.5 | ↓ | 18: | *10.6 | ↗ | 19: | 10.4 | → | 20: | *10.6 | ↘ |
| 11: | *10.6 | ↗ | | | | | | | | | | | | | | | | | | | | | | | | | | | | | |
| 12: | *10.7 | ↗ | | | | | | | | | | | | | | | | | | | | | | | | | | | | | |
| 13: | 10.3 | ↗ | | | | | | | | | | | | | | | | | | | | | | | | | | | | | |
| 14: | 10.1 | ↗ | | | | | | | | | | | | | | | | | | | | | | | | | | | | | |
| 15: | 10.2 | ↗ | | | | | | | | | | | | | | | | | | | | | | | | | | | | | |
| 16: | 10.2 | ↗ | | | | | | | | | | | | | | | | | | | | | | | | | | | | | |
| 17: | *10.5 | ↓ | | | | | | | | | | | | | | | | | | | | | | | | | | | | | |
| 18: | *10.6 | ↗ | | | | | | | | | | | | | | | | | | | | | | | | | | | | | |
| 19: | 10.4 | → | | | | | | | | | | | | | | | | | | | | | | | | | | | | | |
| 20: | *10.6 | ↘ | | | | | | | | | | | | | | | | | | | | | | | | | | | | | |
| | <table border="1" style="width:100%; border-collapse: collapse;"> <tr> <td style="width:10%;">Serie</td> <td style="width:15%;"></td> <td style="width:10%; text-align: right;">100.0</td> </tr> <tr> <td>Total</td> <td></td> <td style="text-align: right;">198.0</td> </tr> </table> | Serie | | 100.0 | Total | | 198.0 | | | | | | | | | | | | | | | | | | | | | | | | |
| Serie | | 100.0 | | | | | | | | | | | | | | | | | | | | | | | | | | | | | |
| Total | | 198.0 | | | | | | | | | | | | | | | | | | | | | | | | | | | | | |

Hold
27

Skive
4

Simon Mejdahl

Vilsted Skf.

BK3

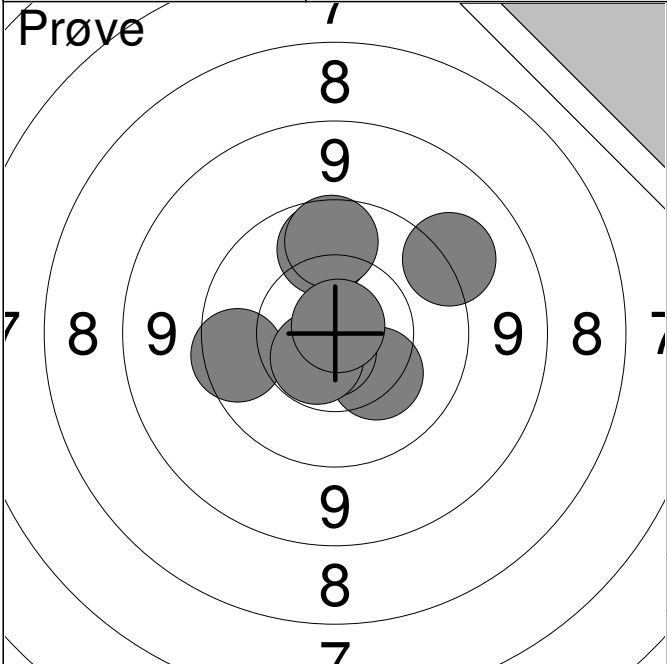

| | | |
|----|-------|---|
| 1: | 9.3 | ↗ |
| 2: | 10.3 | ↘ |
| 3: | 10.0 | ↑ |
| 4: | 9.9 | ↑ |
| 5: | 9.8 | ← |
| 6: | *10.7 | ↘ |
| 7: | *10.6 | ↙ |
| 8: | *10.9 | ↑ |

| | |
|-------|------|
| Serie | 77.0 |
| Total | 0.0 |

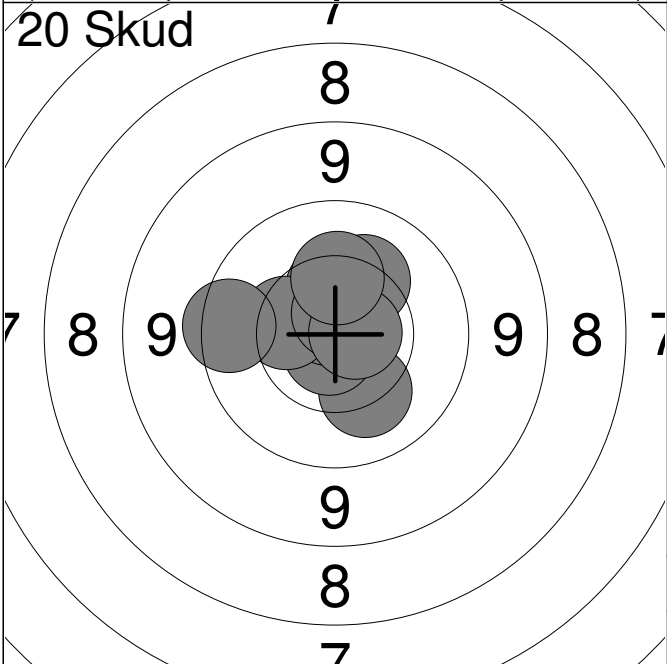

| | | |
|-----|-------|---|
| 1: | 10.4 | ↑ |
| 2: | 10.2 | ↘ |
| 3: | *10.8 | ↘ |
| 4: | *10.8 | ↑ |
| 5: | 10.4 | ← |
| 6: | *10.7 | ↑ |
| 7: | 10.3 | ↗ |
| 8: | 9.7 | ← |
| 9: | *10.7 | → |
| 10: | 10.3 | ↑ |

| | |
|-------|------|
| Serie | 99.0 |
| Total | 99.0 |

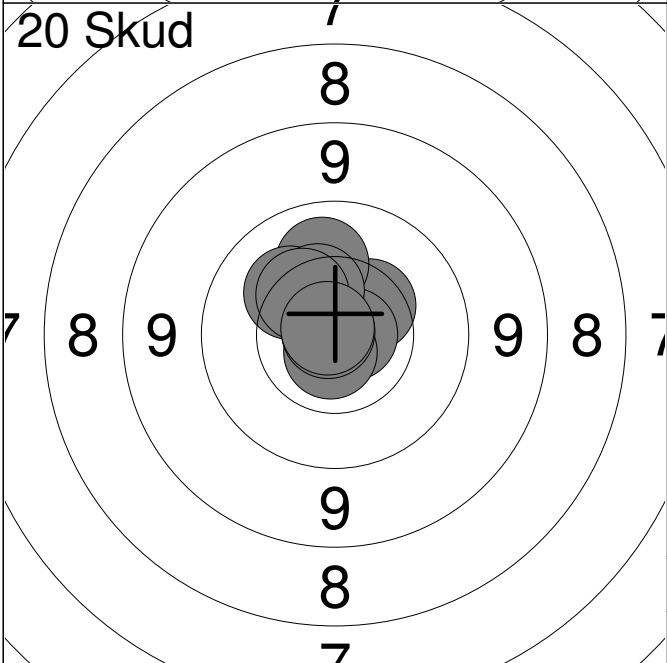

| | | |
|-----|-------|---|
| 11: | *10.8 | ↗ |
| 12: | 10.4 | ↗ |
| 13: | 10.1 | ↑ |
| 14: | *10.8 | → |
| 15: | 10.2 | ↗ |
| 16: | *10.7 | ↘ |
| 17: | *10.9 | ↗ |
| 18: | 10.4 | ↑ |
| 19: | 10.3 | ↗ |
| 20: | *10.8 | ↗ |

| | |
|-------|-------|
| Serie | 100.0 |
| Total | 199.0 |

Hold
27

Skive
5

Hanna Houen Jensen

Vester Hassing Skf.

BK3

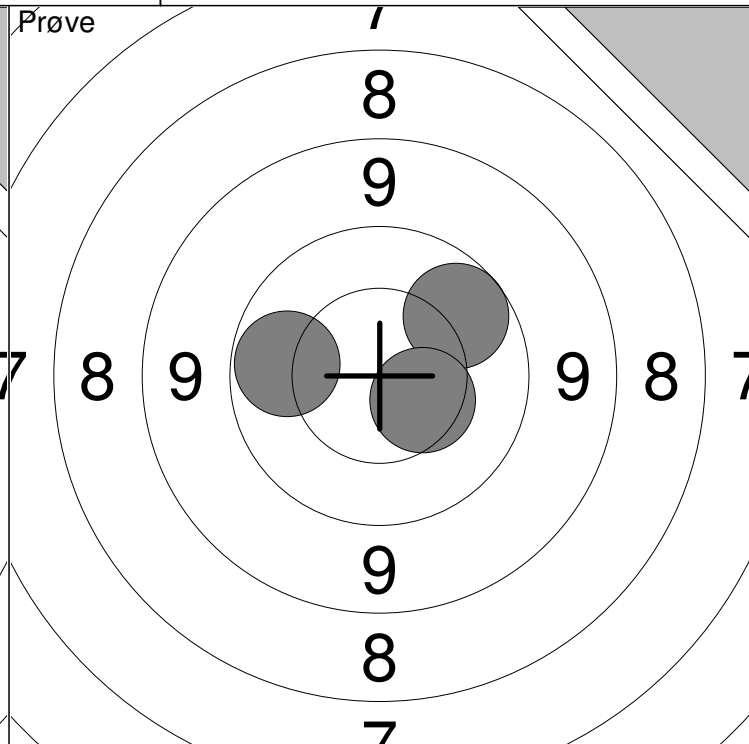
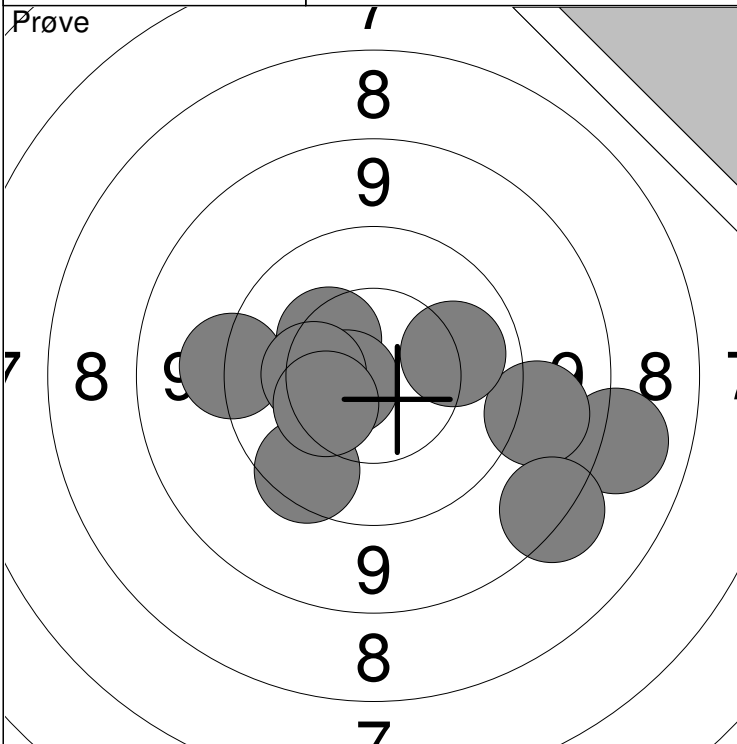

| | |
|----------|---|
| 1: 8.2 | → |
| 2: 9.1 | → |
| 3: 8.5 | ↘ |
| 4: 9.7 | ↙ |
| 5: 9.4 | ← |
| 6: 10.4 | ↖ |
| 7: *10.7 | ↙ |
| 8: 10.3 | ← |
| 9: 10.4 | ↙ |
| 10: 10.1 | → |

| | |
|-------|------|
| Serie | 93.0 |
| Total | 0.0 |

| | |
|----------|---|
| 11: 10.0 | ← |
| 12: 9.9 | ↗ |
| 13: 10.4 | ↘ |

| | |
|-------|------|
| Serie | 29.0 |
| Total | 0.0 |

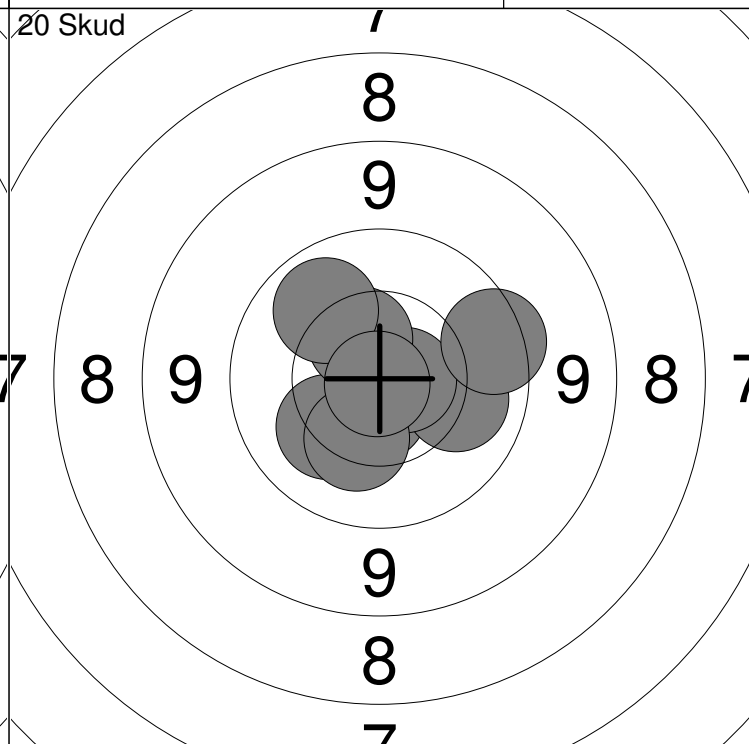
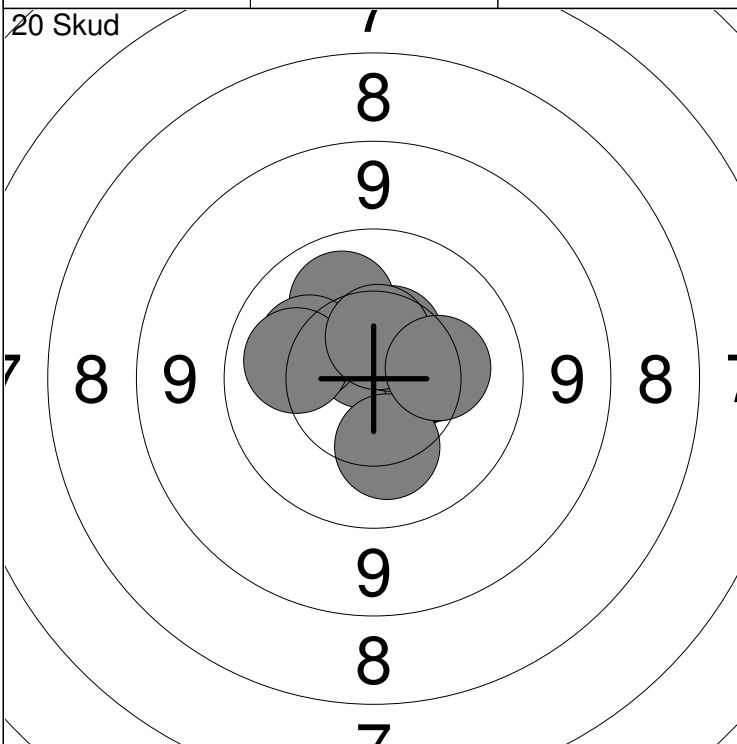

| | |
|----------|---|
| 1: 10.6 | → |
| 2: *10.7 | ↗ |
| 3: 10.1 | ↗ |
| 4: 10.2 | ↖ |
| 5: 10.1 | ← |
| 6: 10.3 | → |
| 7: 10.5 | ↗ |
| 8: 10.5 | ↑ |
| 9: 10.2 | ↘ |
| 10: 10.3 | → |

| | |
|-------|-------|
| Serie | 100.0 |
| Total | 100.0 |

| | |
|-----------|---|
| 11: *10.8 | ↘ |
| 12: *10.6 | ↘ |
| 13: 10.1 | → |
| 14: 10.2 | ↙ |
| 15: *10.7 | → |
| 16: 9.7 | → |
| 17: 10.5 | ↗ |
| 18: 10.1 | ↗ |
| 19: 10.3 | ↘ |
| 20: *10.9 | ↘ |

| | |
|-------|-------|
| Serie | 99.0 |
| Total | 199.0 |

Hold
27

Skive
6

Andreas Mejdahl

Vilsted Skf.

BK3

Prøve

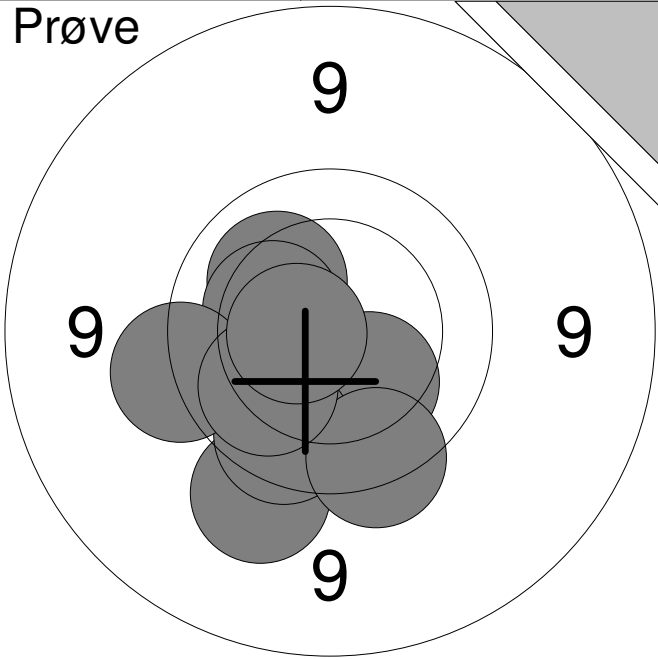

| | | |
|----|-------|---|
| 1: | 10.2 | ↗ |
| 2: | 10.3 | ↘ |
| 3: | 9.4 | ↘ |
| 4: | 9.8 | ↘ |
| 5: | 9.7 | ↘ |
| 6: | 10.3 | ↗ |
| 7: | 9.6 | ↖ |
| 8: | 10.1 | ↖ |
| 9: | *10.6 | ↖ |

| | |
|-------|------|
| Serie | 86.0 |
| Total | 0.0 |

20 Skud

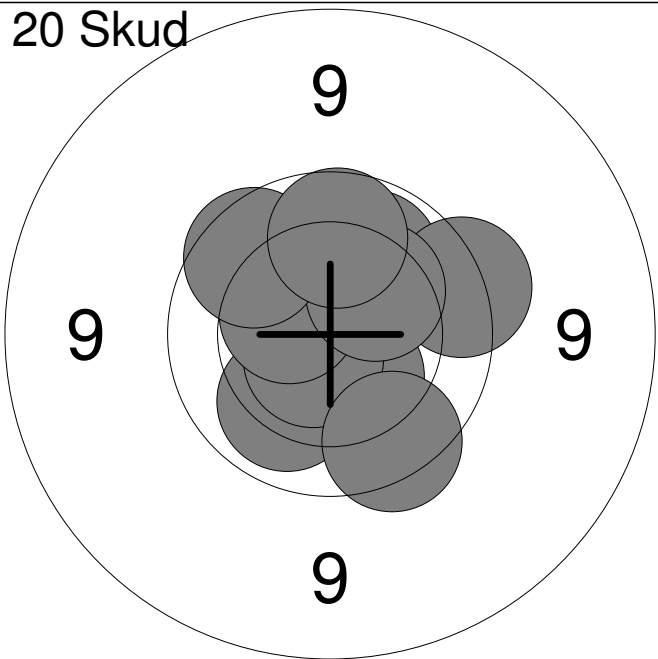

| | | |
|-----|-------|---|
| 1: | 10.4 | ↘ |
| 2: | 10.1 | ↘ |
| 3: | *10.6 | ↘ |
| 4: | 10.0 | ↗ |
| 5: | 10.5 | ↗ |
| 6: | 9.8 | ↘ |
| 7: | 9.7 | → |
| 8: | 10.3 | ↗ |
| 9: | 9.9 | ↗ |
| 10: | 9.9 | ↑ |

| | |
|-------|------|
| Serie | 96.0 |
| Total | 96.0 |

20 Skud

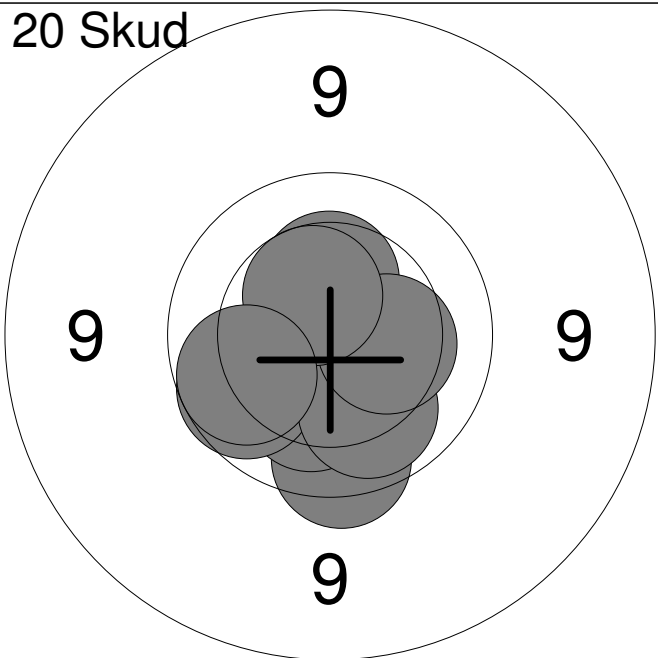

| | | |
|-----|------|---|
| 11: | 10.5 | ↖ |
| 12: | 10.4 | ↑ |
| 13: | 10.2 | ↘ |
| 14: | 9.8 | ↘ |
| 15: | 10.2 | ↘ |
| 16: | 9.9 | ↖ |
| 17: | 10.1 | ↘ |
| 18: | 10.3 | → |
| 19: | 10.5 | ↗ |
| 20: | 9.9 | ↖ |

| | |
|-------|-------|
| Serie | 97.0 |
| Total | 193.0 |

Hold
27

Skive
7

Elisabeth Bisgaard Larsen

Vilsted Skf.

BK1

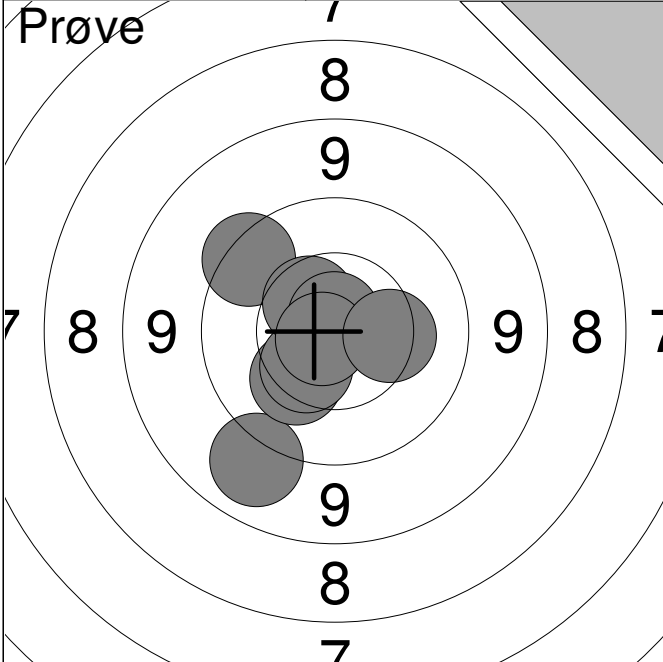

| | | |
|----|-------|---|
| 1: | 9.1 | ↙ |
| 2: | 10.2 | ↙ |
| 3: | *10.7 | ↗ |
| 4: | 10.4 | ↙ |
| 5: | 9.6 | ↗ |
| 6: | 10.5 | ↗ |
| 7: | *10.8 | ↑ |
| 8: | *10.8 | ↙ |
| 9: | 10.3 | → |

| | |
|-------|------|
| Serie | 88.0 |
| Total | 0.0 |

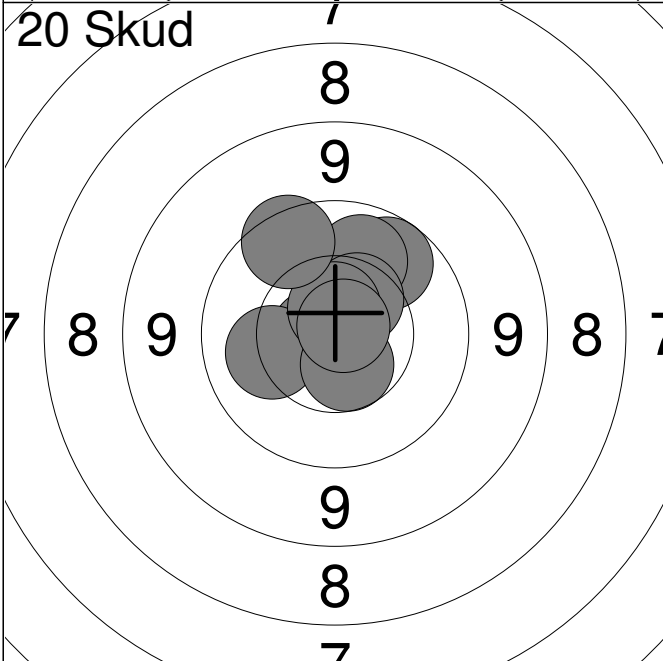

| | | |
|-----|-------|---|
| 1: | *10.8 | ↗ |
| 2: | 9.9 | ↗ |
| 3: | *10.7 | ← |
| 4: | 10.2 | ← |
| 5: | 10.6 | ↓ |
| 6: | 10.1 | ↑ |
| 7: | 10.5 | ↗ |
| 8: | *10.6 | ↑ |
| 9: | 9.7 | ↗ |
| 10: | *10.8 | ↗ |

| | |
|-------|------|
| Serie | 98.0 |
| Total | 98.0 |

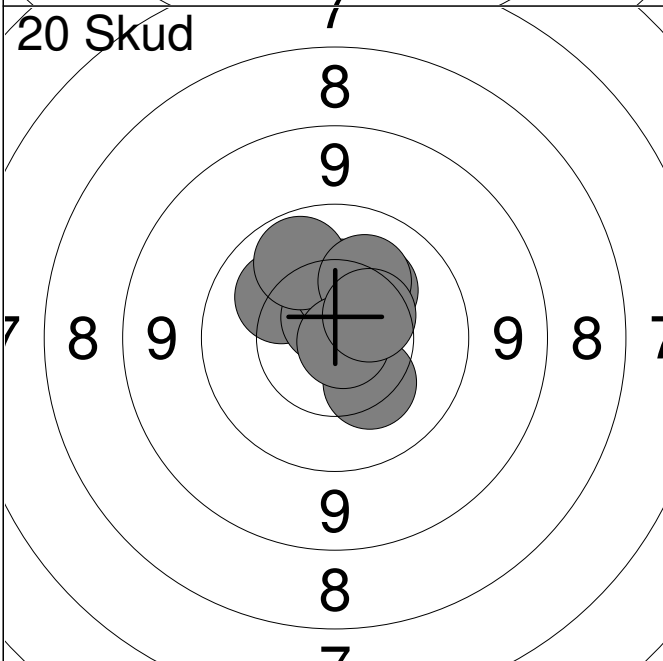

| | | |
|-----|-------|---|
| 11: | 10.3 | ↗ |
| 12: | 10.2 | ↗ |
| 13: | *10.7 | ↑ |
| 14: | 10.3 | ↑ |
| 15: | 10.3 | ↓ |
| 16: | 10.5 | ↗ |
| 17: | 10.0 | ↑ |
| 18: | 10.2 | ↑ |
| 19: | *10.8 | ↘ |
| 20: | 10.5 | ↗ |

| | |
|-------|-------|
| Serie | 100.0 |
| Total | 198.0 |

Hold
27

Skive
8

Sofie Christensen

Vadum Skf.

BK3

Prøve

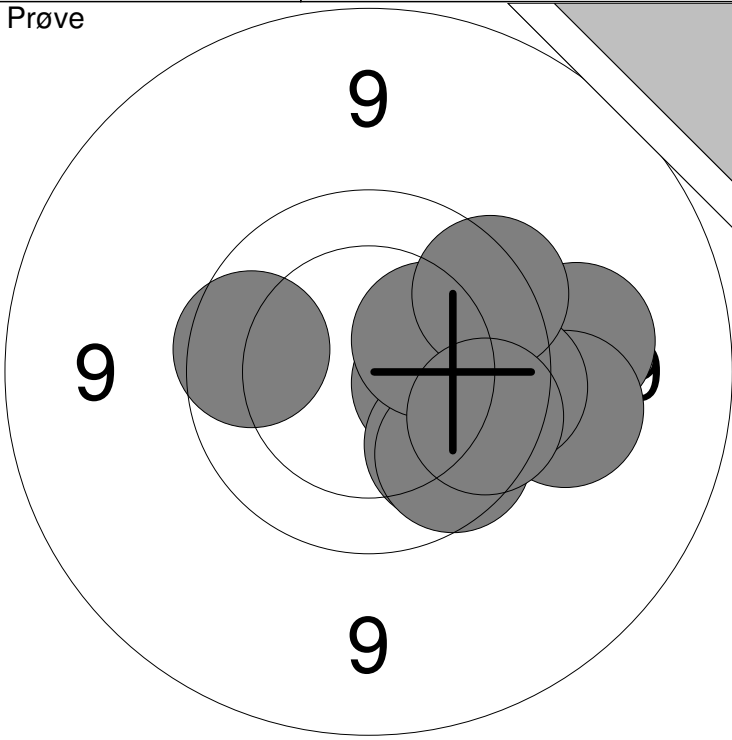

Prøve

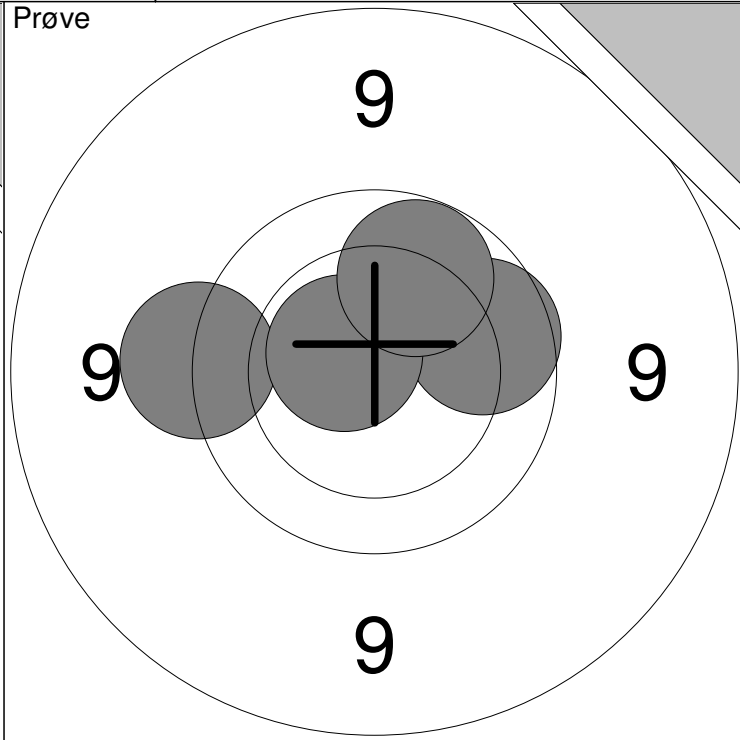

| | | | |
|---------|---|---------|---|
| 1: 9.4 | → | 6: 9.9 | ← |
| 2: 10.3 | → | 7: 9.7 | → |
| 3: 9.4 | → | 8: 10.3 | → |
| 4: 9.9 | ↘ | 9: 9.7 | ↗ |
| 5: 9.9 | ↘ | 10: 9.8 | ↘ |

| | |
|-------|------|
| Serie | 92.0 |
| Total | 0.0 |

| | |
|-----------|---|
| 11: 9.9 | → |
| 12: 9.6 | ← |
| 13: *10.6 | ↖ |
| 14: 10.0 | ↗ |

| | |
|-------|------|
| Serie | 38.0 |
| Total | 0.0 |

20 Skud

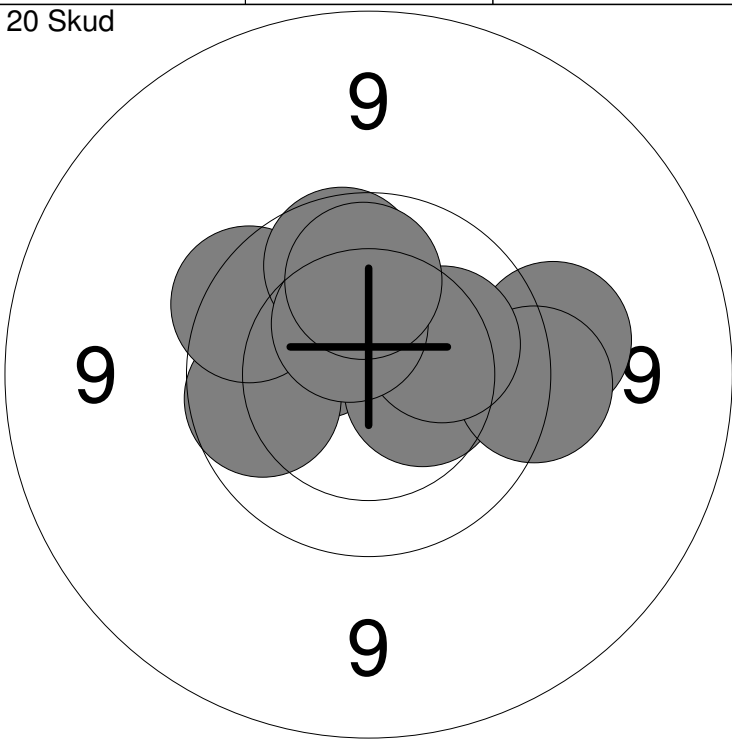

20 Skud

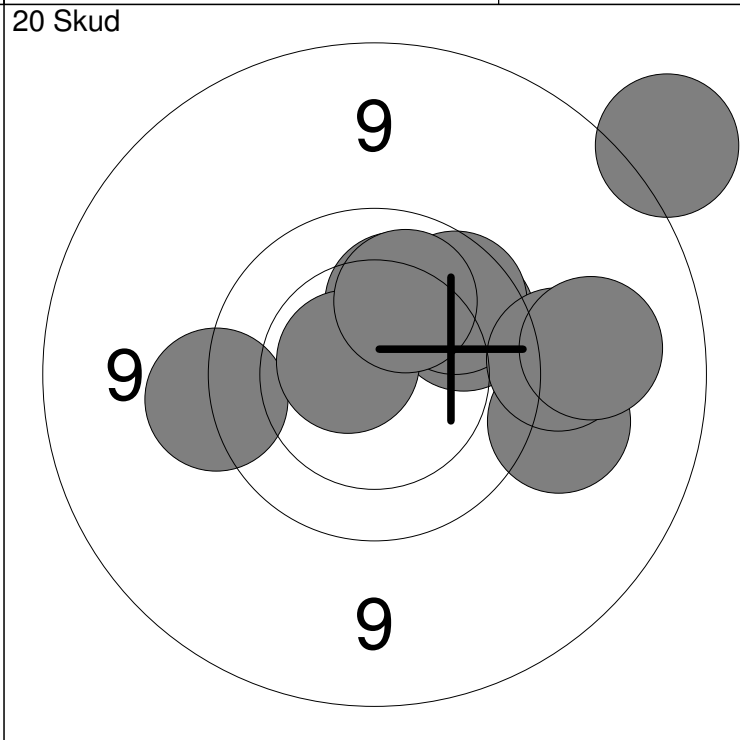

| | | | |
|---------|---|----------|---|
| 1: 10.4 | ↖ | 6: 10.4 | → |
| 2: 9.5 | → | 7: 9.6 | → |
| 3: 9.9 | ← | 8: 10.2 | → |
| 4: 9.8 | ↖ | 9: 10.4 | ↗ |
| 5: 9.9 | ↗ | 10: 10.0 | ↗ |

| | |
|-------|------|
| Serie | 95.0 |
| Total | 95.0 |

| | | | |
|----------|---|-----------|---|
| 11: 9.9 | ↗ | 16: 9.6 | ← |
| 12: 9.4 | → | 17: 9.4 | → |
| 13: 8.5 | ↗ | 18: *10.6 | ↖ |
| 14: 9.9 | ↗ | 19: 9.2 | → |
| 15: 10.2 | ↗ | 20: 10.1 | ↗ |

| | |
|-------|-------|
| Serie | 92.0 |
| Total | 187.0 |

| | | | | | | | | | | | | | | | | | | | | |
|---------------------|---|----|------|---|----|------|---|----|------|---|----|-------|---|----|-------|---|-------|------|-------|-----|
| <p>Prøve</p> | <table style="width:100%; border-collapse: collapse;"> <tr><td style="text-align: right;">1:</td><td style="text-align: right;">10.0</td><td style="text-align: right;">→</td></tr> <tr><td style="text-align: right;">2:</td><td style="text-align: right;">10.2</td><td style="text-align: right;">↑</td></tr> <tr><td style="text-align: right;">3:</td><td style="text-align: right;">10.3</td><td style="text-align: right;">↙</td></tr> <tr><td style="text-align: right;">4:</td><td style="text-align: right;">*10.9</td><td style="text-align: right;">↘</td></tr> <tr><td style="text-align: right;">5:</td><td style="text-align: right;">*10.6</td><td style="text-align: right;">→</td></tr> </table> <table border="1" style="width:100%; border-collapse: collapse; margin-top: 10px;"> <tr> <td style="width:80%;">Serie</td> <td style="text-align: right;">50.0</td> </tr> <tr> <td>Total</td> <td style="text-align: right;">0.0</td> </tr> </table> | 1: | 10.0 | → | 2: | 10.2 | ↑ | 3: | 10.3 | ↙ | 4: | *10.9 | ↘ | 5: | *10.6 | → | Serie | 50.0 | Total | 0.0 |
| 1: | 10.0 | → | | | | | | | | | | | | | | | | | | |
| 2: | 10.2 | ↑ | | | | | | | | | | | | | | | | | | |
| 3: | 10.3 | ↙ | | | | | | | | | | | | | | | | | | |
| 4: | *10.9 | ↘ | | | | | | | | | | | | | | | | | | |
| 5: | *10.6 | → | | | | | | | | | | | | | | | | | | |
| Serie | 50.0 | | | | | | | | | | | | | | | | | | | |
| Total | 0.0 | | | | | | | | | | | | | | | | | | | |

| | | | | | | | | | | | | | | | | | | | | | | | | | | | | | | | | | | | |
|-----------------------|---|----|------|---|----|-------|---|----|------|---|----|-----|---|----|-----|---|----|------|---|----|------|---|----|------|---|----|------|---|-----|------|---|-------|------|-------|------|
| <p>20 Skud</p> | <table style="width:100%; border-collapse: collapse;"> <tr><td style="text-align: right;">1:</td><td style="text-align: right;">10.2</td><td style="text-align: right;">↙</td></tr> <tr><td style="text-align: right;">2:</td><td style="text-align: right;">*10.7</td><td style="text-align: right;">↘</td></tr> <tr><td style="text-align: right;">3:</td><td style="text-align: right;">10.2</td><td style="text-align: right;">↘</td></tr> <tr><td style="text-align: right;">4:</td><td style="text-align: right;">9.9</td><td style="text-align: right;">↙</td></tr> <tr><td style="text-align: right;">5:</td><td style="text-align: right;">9.6</td><td style="text-align: right;">→</td></tr> <tr><td style="text-align: right;">6:</td><td style="text-align: right;">10.2</td><td style="text-align: right;">←</td></tr> <tr><td style="text-align: right;">7:</td><td style="text-align: right;">10.2</td><td style="text-align: right;">←</td></tr> <tr><td style="text-align: right;">8:</td><td style="text-align: right;">10.1</td><td style="text-align: right;">↘</td></tr> <tr><td style="text-align: right;">9:</td><td style="text-align: right;">10.1</td><td style="text-align: right;">↗</td></tr> <tr><td style="text-align: right;">10:</td><td style="text-align: right;">10.1</td><td style="text-align: right;">→</td></tr> </table> <table border="1" style="width:100%; border-collapse: collapse; margin-top: 10px;"> <tr> <td style="width:80%;">Serie</td> <td style="text-align: right;">98.0</td> </tr> <tr> <td>Total</td> <td style="text-align: right;">98.0</td> </tr> </table> | 1: | 10.2 | ↙ | 2: | *10.7 | ↘ | 3: | 10.2 | ↘ | 4: | 9.9 | ↙ | 5: | 9.6 | → | 6: | 10.2 | ← | 7: | 10.2 | ← | 8: | 10.1 | ↘ | 9: | 10.1 | ↗ | 10: | 10.1 | → | Serie | 98.0 | Total | 98.0 |
| 1: | 10.2 | ↙ | | | | | | | | | | | | | | | | | | | | | | | | | | | | | | | | | |
| 2: | *10.7 | ↘ | | | | | | | | | | | | | | | | | | | | | | | | | | | | | | | | | |
| 3: | 10.2 | ↘ | | | | | | | | | | | | | | | | | | | | | | | | | | | | | | | | | |
| 4: | 9.9 | ↙ | | | | | | | | | | | | | | | | | | | | | | | | | | | | | | | | | |
| 5: | 9.6 | → | | | | | | | | | | | | | | | | | | | | | | | | | | | | | | | | | |
| 6: | 10.2 | ← | | | | | | | | | | | | | | | | | | | | | | | | | | | | | | | | | |
| 7: | 10.2 | ← | | | | | | | | | | | | | | | | | | | | | | | | | | | | | | | | | |
| 8: | 10.1 | ↘ | | | | | | | | | | | | | | | | | | | | | | | | | | | | | | | | | |
| 9: | 10.1 | ↗ | | | | | | | | | | | | | | | | | | | | | | | | | | | | | | | | | |
| 10: | 10.1 | → | | | | | | | | | | | | | | | | | | | | | | | | | | | | | | | | | |
| Serie | 98.0 | | | | | | | | | | | | | | | | | | | | | | | | | | | | | | | | | | |
| Total | 98.0 | | | | | | | | | | | | | | | | | | | | | | | | | | | | | | | | | | |

| | | | | | | | | | | | | | | | | | | | | | | | | | | | | | | | | | | | |
|-----------------------|---|-----|-------|---|-----|-------|---|-----|-------|---|-----|------|---|-----|-----|---|-----|------|---|-----|-----|---|-----|------|---|-----|------|---|-----|------|---|-------|------|-------|-------|
| <p>20 Skud</p> | <table style="width:100%; border-collapse: collapse;"> <tr><td style="text-align: right;">11:</td><td style="text-align: right;">*10.5</td><td style="text-align: right;">←</td></tr> <tr><td style="text-align: right;">12:</td><td style="text-align: right;">*10.7</td><td style="text-align: right;">↘</td></tr> <tr><td style="text-align: right;">13:</td><td style="text-align: right;">*10.5</td><td style="text-align: right;">↘</td></tr> <tr><td style="text-align: right;">14:</td><td style="text-align: right;">10.2</td><td style="text-align: right;">↗</td></tr> <tr><td style="text-align: right;">15:</td><td style="text-align: right;">9.7</td><td style="text-align: right;">←</td></tr> <tr><td style="text-align: right;">16:</td><td style="text-align: right;">10.3</td><td style="text-align: right;">↘</td></tr> <tr><td style="text-align: right;">17:</td><td style="text-align: right;">9.2</td><td style="text-align: right;">→</td></tr> <tr><td style="text-align: right;">18:</td><td style="text-align: right;">10.3</td><td style="text-align: right;">↙</td></tr> <tr><td style="text-align: right;">19:</td><td style="text-align: right;">10.4</td><td style="text-align: right;">↘</td></tr> <tr><td style="text-align: right;">20:</td><td style="text-align: right;">10.3</td><td style="text-align: right;">↗</td></tr> </table> <table border="1" style="width:100%; border-collapse: collapse; margin-top: 10px;"> <tr> <td style="width:80%;">Serie</td> <td style="text-align: right;">98.0</td> </tr> <tr> <td>Total</td> <td style="text-align: right;">196.0</td> </tr> </table> | 11: | *10.5 | ← | 12: | *10.7 | ↘ | 13: | *10.5 | ↘ | 14: | 10.2 | ↗ | 15: | 9.7 | ← | 16: | 10.3 | ↘ | 17: | 9.2 | → | 18: | 10.3 | ↙ | 19: | 10.4 | ↘ | 20: | 10.3 | ↗ | Serie | 98.0 | Total | 196.0 |
| 11: | *10.5 | ← | | | | | | | | | | | | | | | | | | | | | | | | | | | | | | | | | |
| 12: | *10.7 | ↘ | | | | | | | | | | | | | | | | | | | | | | | | | | | | | | | | | |
| 13: | *10.5 | ↘ | | | | | | | | | | | | | | | | | | | | | | | | | | | | | | | | | |
| 14: | 10.2 | ↗ | | | | | | | | | | | | | | | | | | | | | | | | | | | | | | | | | |
| 15: | 9.7 | ← | | | | | | | | | | | | | | | | | | | | | | | | | | | | | | | | | |
| 16: | 10.3 | ↘ | | | | | | | | | | | | | | | | | | | | | | | | | | | | | | | | | |
| 17: | 9.2 | → | | | | | | | | | | | | | | | | | | | | | | | | | | | | | | | | | |
| 18: | 10.3 | ↙ | | | | | | | | | | | | | | | | | | | | | | | | | | | | | | | | | |
| 19: | 10.4 | ↘ | | | | | | | | | | | | | | | | | | | | | | | | | | | | | | | | | |
| 20: | 10.3 | ↗ | | | | | | | | | | | | | | | | | | | | | | | | | | | | | | | | | |
| Serie | 98.0 | | | | | | | | | | | | | | | | | | | | | | | | | | | | | | | | | | |
| Total | 196.0 | | | | | | | | | | | | | | | | | | | | | | | | | | | | | | | | | | |

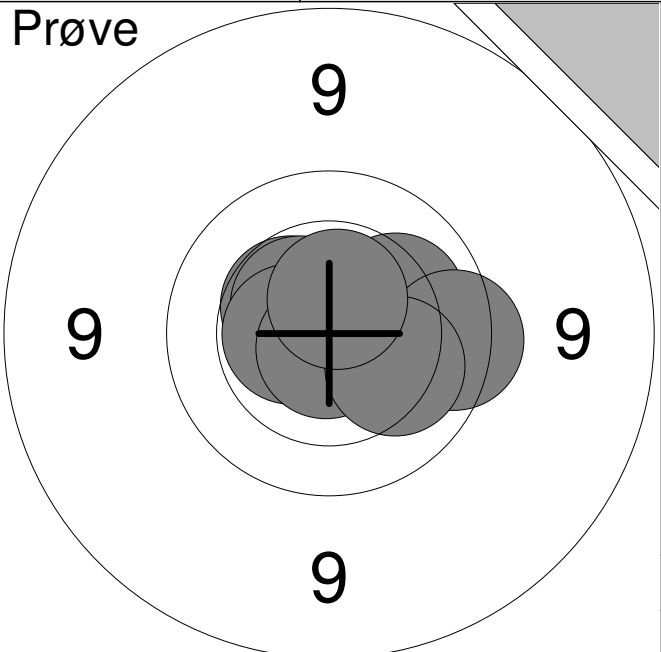
| | | | | | | | | | | | | | | | | | | | | | | | | | | | | | | | | | | |
|--|---|------|------|---|----|-------|---|----|-------|---|----|------|---|----|------|---|----|-----|---|----|-------|---|----|------|---|----|-------|---|-------|--|------|-------|--|-----|
| <p>Prøve</p>  | <table style="width:100%; border-collapse: collapse;"> <tr><td style="width:5%;">1:</td><td style="width:15%;">10.4</td><td style="width:10%; text-align: center;">↗</td></tr> <tr><td>2:</td><td>*10.5</td><td style="text-align: center;">↗</td></tr> <tr><td>3:</td><td>*10.6</td><td style="text-align: center;">←</td></tr> <tr><td>4:</td><td>10.2</td><td style="text-align: center;">→</td></tr> <tr><td>5:</td><td>10.2</td><td style="text-align: center;">↗</td></tr> <tr><td>6:</td><td>9.8</td><td style="text-align: center;">→</td></tr> <tr><td>7:</td><td>*10.8</td><td style="text-align: center;">↓</td></tr> <tr><td>8:</td><td>10.2</td><td style="text-align: center;">↘</td></tr> <tr><td>9:</td><td>*10.6</td><td style="text-align: center;">↗</td></tr> <tr><td colspan="2">Serie</td><td style="text-align: right;">89.0</td></tr> <tr><td colspan="2">Total</td><td style="text-align: right;">0.0</td></tr> </table> | 1: | 10.4 | ↗ | 2: | *10.5 | ↗ | 3: | *10.6 | ← | 4: | 10.2 | → | 5: | 10.2 | ↗ | 6: | 9.8 | → | 7: | *10.8 | ↓ | 8: | 10.2 | ↘ | 9: | *10.6 | ↗ | Serie | | 89.0 | Total | | 0.0 |
| 1: | 10.4 | ↗ | | | | | | | | | | | | | | | | | | | | | | | | | | | | | | | | |
| 2: | *10.5 | ↗ | | | | | | | | | | | | | | | | | | | | | | | | | | | | | | | | |
| 3: | *10.6 | ← | | | | | | | | | | | | | | | | | | | | | | | | | | | | | | | | |
| 4: | 10.2 | → | | | | | | | | | | | | | | | | | | | | | | | | | | | | | | | | |
| 5: | 10.2 | ↗ | | | | | | | | | | | | | | | | | | | | | | | | | | | | | | | | |
| 6: | 9.8 | → | | | | | | | | | | | | | | | | | | | | | | | | | | | | | | | | |
| 7: | *10.8 | ↓ | | | | | | | | | | | | | | | | | | | | | | | | | | | | | | | | |
| 8: | 10.2 | ↘ | | | | | | | | | | | | | | | | | | | | | | | | | | | | | | | | |
| 9: | *10.6 | ↗ | | | | | | | | | | | | | | | | | | | | | | | | | | | | | | | | |
| Serie | | 89.0 | | | | | | | | | | | | | | | | | | | | | | | | | | | | | | | | |
| Total | | 0.0 | | | | | | | | | | | | | | | | | | | | | | | | | | | | | | | | |

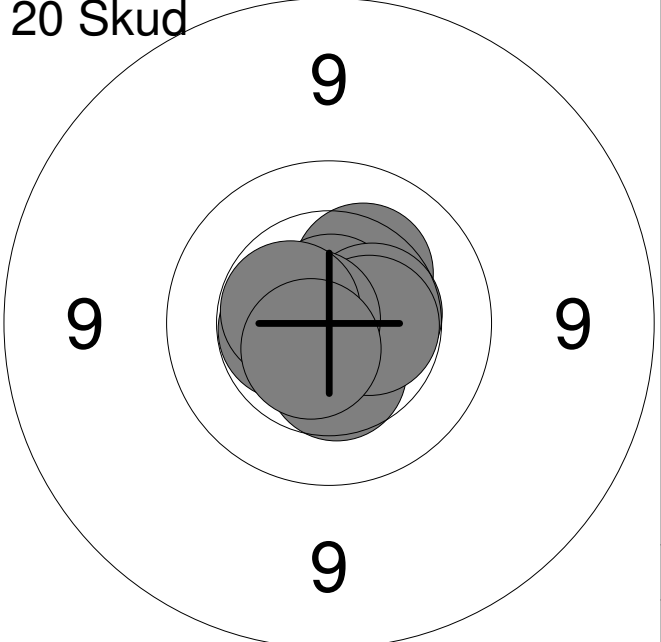
| | | | | | | | | | | | | | | | | | | | | | | | | | | | | | | | | | | | | | |
|---|---|-------|------|---|----|------|---|----|-------|---|----|-------|---|----|------|---|----|-------|---|----|-------|---|----|-------|---|----|-------|---|-----|-------|---|-------|--|-------|-------|--|-------|
| <p>20 Skud</p>  | <table style="width:100%; border-collapse: collapse;"> <tr><td style="width:5%;">1:</td><td style="width:15%;">10.3</td><td style="width:10%; text-align: center;">↗</td></tr> <tr><td>2:</td><td>10.4</td><td style="text-align: center;">↓</td></tr> <tr><td>3:</td><td>*10.7</td><td style="text-align: center;">↑</td></tr> <tr><td>4:</td><td>*10.6</td><td style="text-align: center;">→</td></tr> <tr><td>5:</td><td>10.5</td><td style="text-align: center;">→</td></tr> <tr><td>6:</td><td>*10.5</td><td style="text-align: center;">→</td></tr> <tr><td>7:</td><td>*10.7</td><td style="text-align: center;">←</td></tr> <tr><td>8:</td><td>*10.5</td><td style="text-align: center;">←</td></tr> <tr><td>9:</td><td>*10.5</td><td style="text-align: center;">←</td></tr> <tr><td>10:</td><td>*10.6</td><td style="text-align: center;">↘</td></tr> <tr><td colspan="2">Serie</td><td style="text-align: right;">100.0</td></tr> <tr><td colspan="2">Total</td><td style="text-align: right;">100.0</td></tr> </table> | 1: | 10.3 | ↗ | 2: | 10.4 | ↓ | 3: | *10.7 | ↑ | 4: | *10.6 | → | 5: | 10.5 | → | 6: | *10.5 | → | 7: | *10.7 | ← | 8: | *10.5 | ← | 9: | *10.5 | ← | 10: | *10.6 | ↘ | Serie | | 100.0 | Total | | 100.0 |
| 1: | 10.3 | ↗ | | | | | | | | | | | | | | | | | | | | | | | | | | | | | | | | | | | |
| 2: | 10.4 | ↓ | | | | | | | | | | | | | | | | | | | | | | | | | | | | | | | | | | | |
| 3: | *10.7 | ↑ | | | | | | | | | | | | | | | | | | | | | | | | | | | | | | | | | | | |
| 4: | *10.6 | → | | | | | | | | | | | | | | | | | | | | | | | | | | | | | | | | | | | |
| 5: | 10.5 | → | | | | | | | | | | | | | | | | | | | | | | | | | | | | | | | | | | | |
| 6: | *10.5 | → | | | | | | | | | | | | | | | | | | | | | | | | | | | | | | | | | | | |
| 7: | *10.7 | ← | | | | | | | | | | | | | | | | | | | | | | | | | | | | | | | | | | | |
| 8: | *10.5 | ← | | | | | | | | | | | | | | | | | | | | | | | | | | | | | | | | | | | |
| 9: | *10.5 | ← | | | | | | | | | | | | | | | | | | | | | | | | | | | | | | | | | | | |
| 10: | *10.6 | ↘ | | | | | | | | | | | | | | | | | | | | | | | | | | | | | | | | | | | |
| Serie | | 100.0 | | | | | | | | | | | | | | | | | | | | | | | | | | | | | | | | | | | |
| Total | | 100.0 | | | | | | | | | | | | | | | | | | | | | | | | | | | | | | | | | | | |

| | | | | | | | | | | | | | | | | | | | | | | | | | | | | | | | | | | | | | |
|--|---|-------|------|---|-----|------|---|-----|------|---|-----|------|---|-----|------|---|-----|-------|---|-----|-------|---|-----|------|---|-----|-------|---|-----|-------|---|-------|--|-------|-------|--|-------|
| <p>20 Skud</p>  | <table style="width:100%; border-collapse: collapse;"> <tr><td style="width:5%;">11:</td><td style="width:15%;">10.1</td><td style="width:10%; text-align: center;">←</td></tr> <tr><td>12:</td><td>10.4</td><td style="text-align: center;">↙</td></tr> <tr><td>13:</td><td>10.1</td><td style="text-align: center;">←</td></tr> <tr><td>14:</td><td>10.0</td><td style="text-align: center;">←</td></tr> <tr><td>15:</td><td>10.0</td><td style="text-align: center;">→</td></tr> <tr><td>16:</td><td>*10.5</td><td style="text-align: center;">↘</td></tr> <tr><td>17:</td><td>*10.5</td><td style="text-align: center;">↑</td></tr> <tr><td>18:</td><td>10.4</td><td style="text-align: center;">↗</td></tr> <tr><td>19:</td><td>*10.6</td><td style="text-align: center;">↑</td></tr> <tr><td>20:</td><td>*10.8</td><td style="text-align: center;">↓</td></tr> <tr><td colspan="2">Serie</td><td style="text-align: right;">100.0</td></tr> <tr><td colspan="2">Total</td><td style="text-align: right;">200.0</td></tr> </table> | 11: | 10.1 | ← | 12: | 10.4 | ↙ | 13: | 10.1 | ← | 14: | 10.0 | ← | 15: | 10.0 | → | 16: | *10.5 | ↘ | 17: | *10.5 | ↑ | 18: | 10.4 | ↗ | 19: | *10.6 | ↑ | 20: | *10.8 | ↓ | Serie | | 100.0 | Total | | 200.0 |
| 11: | 10.1 | ← | | | | | | | | | | | | | | | | | | | | | | | | | | | | | | | | | | | |
| 12: | 10.4 | ↙ | | | | | | | | | | | | | | | | | | | | | | | | | | | | | | | | | | | |
| 13: | 10.1 | ← | | | | | | | | | | | | | | | | | | | | | | | | | | | | | | | | | | | |
| 14: | 10.0 | ← | | | | | | | | | | | | | | | | | | | | | | | | | | | | | | | | | | | |
| 15: | 10.0 | → | | | | | | | | | | | | | | | | | | | | | | | | | | | | | | | | | | | |
| 16: | *10.5 | ↘ | | | | | | | | | | | | | | | | | | | | | | | | | | | | | | | | | | | |
| 17: | *10.5 | ↑ | | | | | | | | | | | | | | | | | | | | | | | | | | | | | | | | | | | |
| 18: | 10.4 | ↗ | | | | | | | | | | | | | | | | | | | | | | | | | | | | | | | | | | | |
| 19: | *10.6 | ↑ | | | | | | | | | | | | | | | | | | | | | | | | | | | | | | | | | | | |
| 20: | *10.8 | ↓ | | | | | | | | | | | | | | | | | | | | | | | | | | | | | | | | | | | |
| Serie | | 100.0 | | | | | | | | | | | | | | | | | | | | | | | | | | | | | | | | | | | |
| Total | | 200.0 | | | | | | | | | | | | | | | | | | | | | | | | | | | | | | | | | | | |

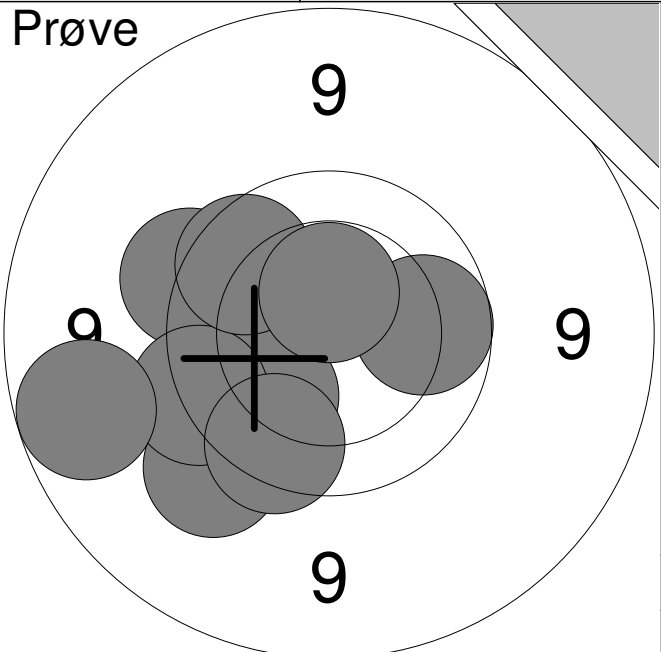
| | | | | | | | | | | | | | | | | | | | | | | | | | | | | |
|--|---|-------|------|-------|-----|-----|---|----|------|---|----|-----|---|----|-----|---|----|-----|---|----|-------|---|----|-----|---|----|-----|---|
| <p>Prøve</p>  | <table style="width:100%; border-collapse: collapse;"> <tr><td>1:</td><td>9.4</td><td>↙</td></tr> <tr><td>2:</td><td>9.6</td><td>↖</td></tr> <tr><td>3:</td><td>10.0</td><td>↙</td></tr> <tr><td>4:</td><td>9.6</td><td>↖</td></tr> <tr><td>5:</td><td>9.9</td><td>↗</td></tr> <tr><td>6:</td><td>9.9</td><td>→</td></tr> <tr><td>7:</td><td>*10.5</td><td>↑</td></tr> <tr><td>8:</td><td>9.0</td><td>↖</td></tr> <tr><td>9:</td><td>9.8</td><td>↙</td></tr> </table> | 1: | 9.4 | ↙ | 2: | 9.6 | ↖ | 3: | 10.0 | ↙ | 4: | 9.6 | ↖ | 5: | 9.9 | ↗ | 6: | 9.9 | → | 7: | *10.5 | ↑ | 8: | 9.0 | ↖ | 9: | 9.8 | ↙ |
| 1: | 9.4 | ↙ | | | | | | | | | | | | | | | | | | | | | | | | | | |
| 2: | 9.6 | ↖ | | | | | | | | | | | | | | | | | | | | | | | | | | |
| 3: | 10.0 | ↙ | | | | | | | | | | | | | | | | | | | | | | | | | | |
| 4: | 9.6 | ↖ | | | | | | | | | | | | | | | | | | | | | | | | | | |
| 5: | 9.9 | ↗ | | | | | | | | | | | | | | | | | | | | | | | | | | |
| 6: | 9.9 | → | | | | | | | | | | | | | | | | | | | | | | | | | | |
| 7: | *10.5 | ↑ | | | | | | | | | | | | | | | | | | | | | | | | | | |
| 8: | 9.0 | ↖ | | | | | | | | | | | | | | | | | | | | | | | | | | |
| 9: | 9.8 | ↙ | | | | | | | | | | | | | | | | | | | | | | | | | | |
| <table style="width:100%; border-collapse: collapse;"> <tr> <td style="width:45%;">Serie</td> <td style="width:55%; text-align: right;">83.0</td> </tr> <tr> <td>Total</td> <td style="text-align: right;">0.0</td> </tr> </table> | | Serie | 83.0 | Total | 0.0 | | | | | | | | | | | | | | | | | | | | | | | |
| Serie | 83.0 | | | | | | | | | | | | | | | | | | | | | | | | | | | |
| Total | 0.0 | | | | | | | | | | | | | | | | | | | | | | | | | | | |

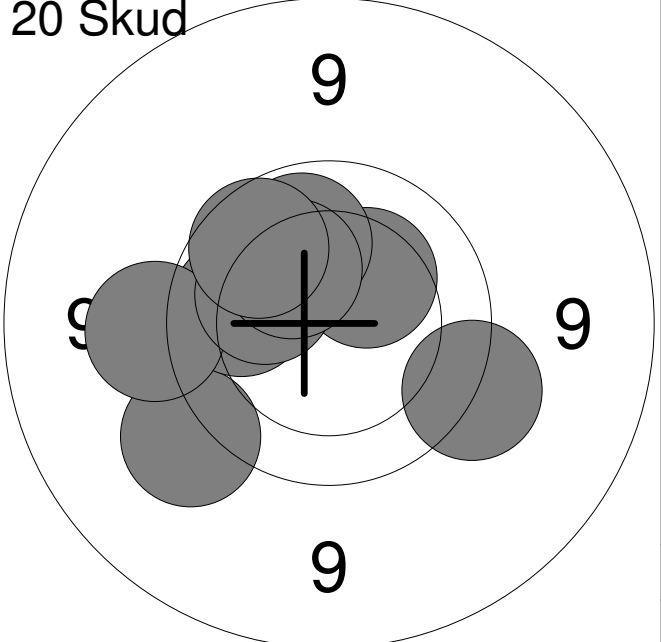
| | | | | | | | | | | | | | | | | | | | | | | | | | | | | | | | |
|---|--|-------|------|-------|------|------|---|----|------|---|----|-----|---|----|------|---|----|-----|---|----|------|---|----|------|---|----|------|---|-----|-----|---|
| <p>20 Skud</p>  | <table style="width:100%; border-collapse: collapse;"> <tr><td>1:</td><td>9.4</td><td>↙</td></tr> <tr><td>2:</td><td>10.3</td><td>↗</td></tr> <tr><td>3:</td><td>10.0</td><td>↖</td></tr> <tr><td>4:</td><td>9.4</td><td>↖</td></tr> <tr><td>5:</td><td>10.0</td><td>↗</td></tr> <tr><td>6:</td><td>9.5</td><td>↘</td></tr> <tr><td>7:</td><td>10.2</td><td>↗</td></tr> <tr><td>8:</td><td>10.2</td><td>↗</td></tr> <tr><td>9:</td><td>10.2</td><td>↗</td></tr> <tr><td>10:</td><td>9.9</td><td>↗</td></tr> </table> | 1: | 9.4 | ↙ | 2: | 10.3 | ↗ | 3: | 10.0 | ↖ | 4: | 9.4 | ↖ | 5: | 10.0 | ↗ | 6: | 9.5 | ↘ | 7: | 10.2 | ↗ | 8: | 10.2 | ↗ | 9: | 10.2 | ↗ | 10: | 9.9 | ↗ |
| 1: | 9.4 | ↙ | | | | | | | | | | | | | | | | | | | | | | | | | | | | | |
| 2: | 10.3 | ↗ | | | | | | | | | | | | | | | | | | | | | | | | | | | | | |
| 3: | 10.0 | ↖ | | | | | | | | | | | | | | | | | | | | | | | | | | | | | |
| 4: | 9.4 | ↖ | | | | | | | | | | | | | | | | | | | | | | | | | | | | | |
| 5: | 10.0 | ↗ | | | | | | | | | | | | | | | | | | | | | | | | | | | | | |
| 6: | 9.5 | ↘ | | | | | | | | | | | | | | | | | | | | | | | | | | | | | |
| 7: | 10.2 | ↗ | | | | | | | | | | | | | | | | | | | | | | | | | | | | | |
| 8: | 10.2 | ↗ | | | | | | | | | | | | | | | | | | | | | | | | | | | | | |
| 9: | 10.2 | ↗ | | | | | | | | | | | | | | | | | | | | | | | | | | | | | |
| 10: | 9.9 | ↗ | | | | | | | | | | | | | | | | | | | | | | | | | | | | | |
| <table style="width:100%; border-collapse: collapse;"> <tr> <td style="width:45%;">Serie</td> <td style="width:55%; text-align: right;">96.0</td> </tr> <tr> <td>Total</td> <td style="text-align: right;">96.0</td> </tr> </table> | | Serie | 96.0 | Total | 96.0 | | | | | | | | | | | | | | | | | | | | | | | | | | |
| Serie | 96.0 | | | | | | | | | | | | | | | | | | | | | | | | | | | | | | |
| Total | 96.0 | | | | | | | | | | | | | | | | | | | | | | | | | | | | | | |

| | | | | | | | | | | | | | | | | | | | | | | | | | | | | | | | |
|--|--|-------|-------|-------|-------|-----|---|-----|-------|---|-----|-------|---|-----|-------|---|-----|-----|---|-----|-----|---|-----|-------|---|-----|------|---|-----|-------|---|
| <p>20 Skud</p>  | <table style="width:100%; border-collapse: collapse;"> <tr><td>11:</td><td>*10.8</td><td>↑</td></tr> <tr><td>12:</td><td>9.8</td><td>↖</td></tr> <tr><td>13:</td><td>*10.5</td><td>↘</td></tr> <tr><td>14:</td><td>*10.5</td><td>↗</td></tr> <tr><td>15:</td><td>*10.7</td><td>↑</td></tr> <tr><td>16:</td><td>8.7</td><td>→</td></tr> <tr><td>17:</td><td>8.7</td><td>↖</td></tr> <tr><td>18:</td><td>*10.6</td><td>↑</td></tr> <tr><td>19:</td><td>10.3</td><td>↖</td></tr> <tr><td>20:</td><td>*10.5</td><td>↘</td></tr> </table> | 11: | *10.8 | ↑ | 12: | 9.8 | ↖ | 13: | *10.5 | ↘ | 14: | *10.5 | ↗ | 15: | *10.7 | ↑ | 16: | 8.7 | → | 17: | 8.7 | ↖ | 18: | *10.6 | ↑ | 19: | 10.3 | ↖ | 20: | *10.5 | ↘ |
| 11: | *10.8 | ↑ | | | | | | | | | | | | | | | | | | | | | | | | | | | | | |
| 12: | 9.8 | ↖ | | | | | | | | | | | | | | | | | | | | | | | | | | | | | |
| 13: | *10.5 | ↘ | | | | | | | | | | | | | | | | | | | | | | | | | | | | | |
| 14: | *10.5 | ↗ | | | | | | | | | | | | | | | | | | | | | | | | | | | | | |
| 15: | *10.7 | ↑ | | | | | | | | | | | | | | | | | | | | | | | | | | | | | |
| 16: | 8.7 | → | | | | | | | | | | | | | | | | | | | | | | | | | | | | | |
| 17: | 8.7 | ↖ | | | | | | | | | | | | | | | | | | | | | | | | | | | | | |
| 18: | *10.6 | ↑ | | | | | | | | | | | | | | | | | | | | | | | | | | | | | |
| 19: | 10.3 | ↖ | | | | | | | | | | | | | | | | | | | | | | | | | | | | | |
| 20: | *10.5 | ↘ | | | | | | | | | | | | | | | | | | | | | | | | | | | | | |
| <table style="width:100%; border-collapse: collapse;"> <tr> <td style="width:45%;">Serie</td> <td style="width:55%; text-align: right;">95.0</td> </tr> <tr> <td>Total</td> <td style="text-align: right;">191.0</td> </tr> </table> | | Serie | 95.0 | Total | 191.0 | | | | | | | | | | | | | | | | | | | | | | | | | | |
| Serie | 95.0 | | | | | | | | | | | | | | | | | | | | | | | | | | | | | | |
| Total | 191.0 | | | | | | | | | | | | | | | | | | | | | | | | | | | | | | |

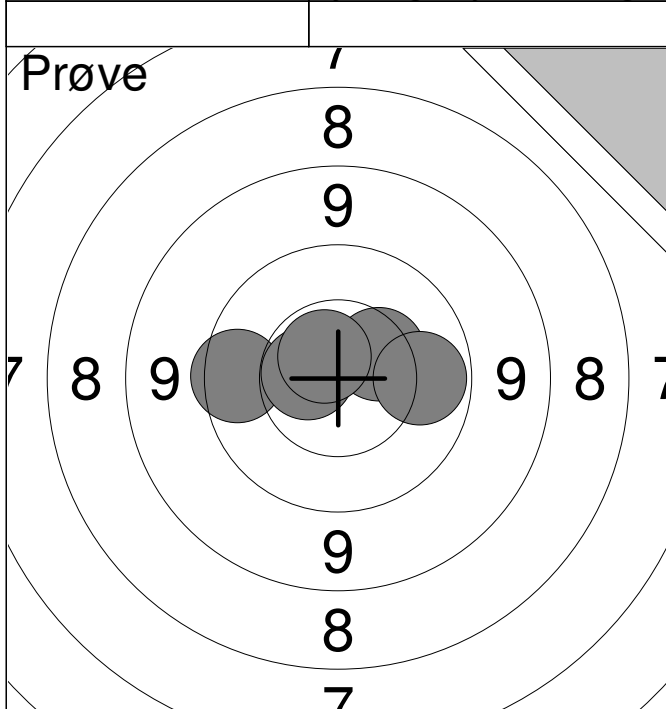

| | | |
|--------------|-------|-------------|
| 1: | 9.8 | ← |
| 2: | 10.4 | ↗ |
| 3: | 10.0 | → |
| 4: | *10.6 | ← |
| 5: | *10.6 | ↗ |
| Serie | | 49.0 |
| Total | | 0.0 |

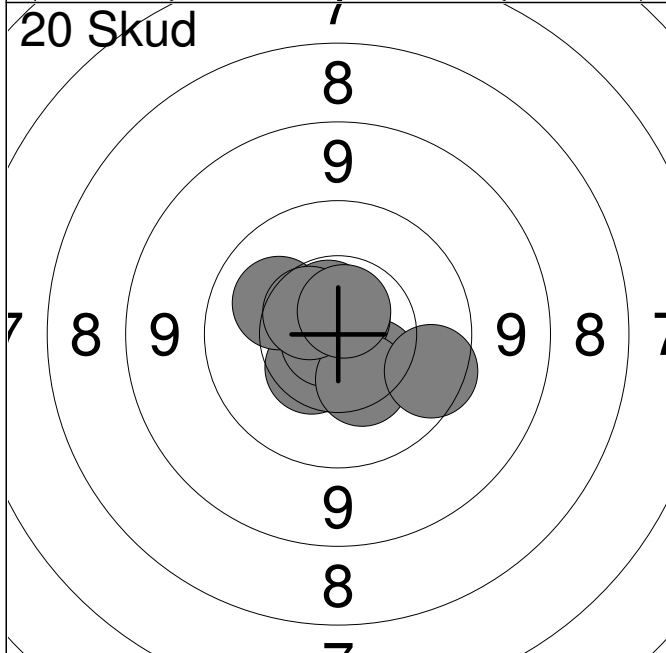

| | | |
|--------------|-------|-------------|
| 1: | 10.4 | ↘ |
| 2: | 10.5 | ↙ |
| 3: | *10.8 | ← |
| 4: | *10.8 | ↗ |
| 5: | 10.4 | ↘ |
| 6: | 9.8 | ↘ |
| 7: | 10.2 | ↗ |
| 8: | *10.6 | ↗ |
| 9: | 10.5 | ↗ |
| 10: | *10.7 | ↗ |
| Serie | | 99.0 |
| Total | | 99.0 |

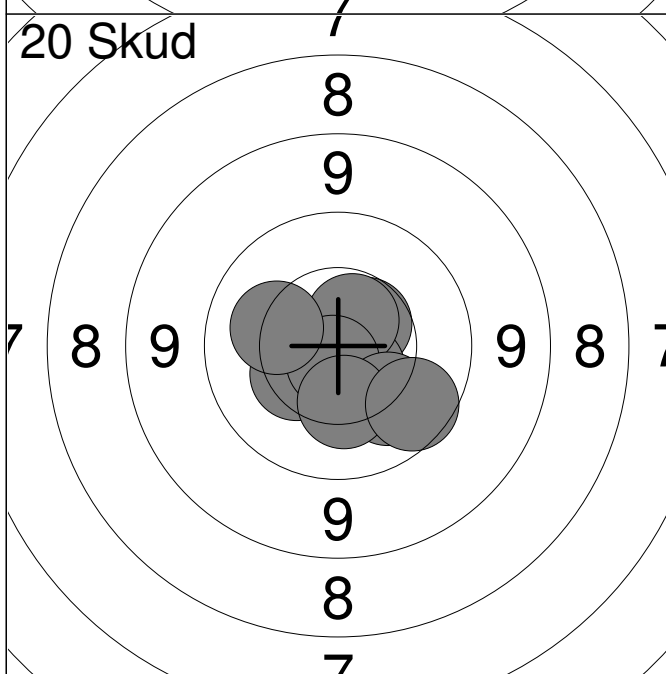

| | | |
|--------------|-------|--------------|
| 11: | 10.5 | ↗ |
| 12: | 10.4 | ↙ |
| 13: | *10.8 | ↘ |
| 14: | *10.6 | ↘ |
| 15: | *10.6 | ↗ |
| 16: | *10.8 | ↙ |
| 17: | 10.1 | ↘ |
| 18: | 10.3 | ↘ |
| 19: | 9.9 | ↘ |
| 20: | 10.2 | ↖ |
| Serie | | 99.0 |
| Total | | 198.0 |

Hold
28

Skive
2

Mads Flyvholm Olsen

Hjørring Skytteforening

J2

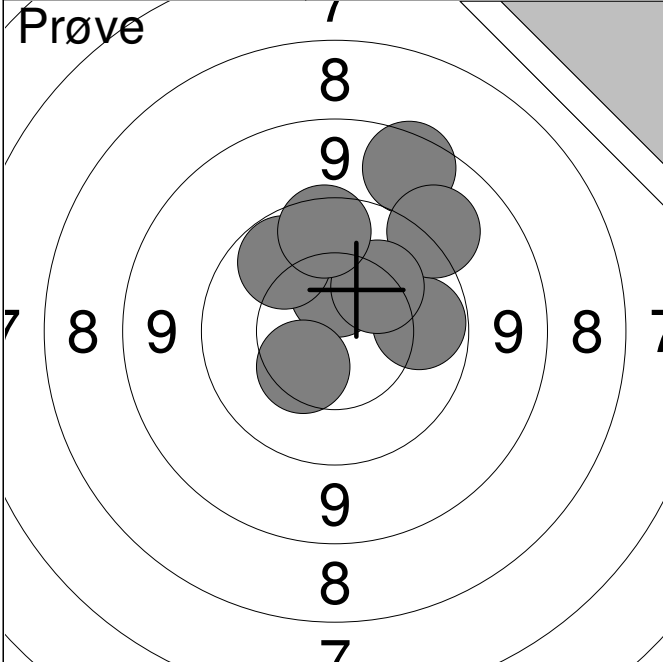

| | | |
|----|------|---|
| 1: | 10.5 | ↑ |
| 2: | 8.8 | ↗ |
| 3: | 10.0 | → |
| 4: | 10.0 | ↖ |
| 5: | 9.3 | ↗ |
| 6: | 10.4 | ↙ |
| 7: | 10.2 | ↗ |
| 8: | 9.8 | ↑ |

| | |
|-------|------|
| Serie | 76.0 |
| Total | 0.0 |

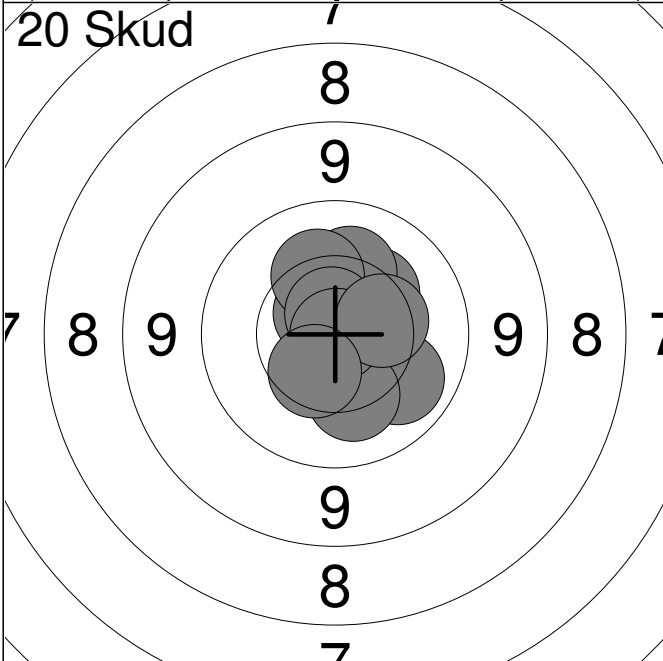

| | | |
|-----|-------|---|
| 1: | 10.3 | ↗ |
| 2: | *10.7 | ↖ |
| 3: | 10.2 | ↑ |
| 4: | 10.2 | ↑ |
| 5: | 10.1 | ↘ |
| 6: | 10.2 | ↘ |
| 7: | *10.7 | ↑ |
| 8: | *10.9 | ↘ |
| 9: | 10.4 | → |
| 10: | 10.5 | ↙ |

| | |
|-------|-------|
| Serie | 100.0 |
| Total | 100.0 |

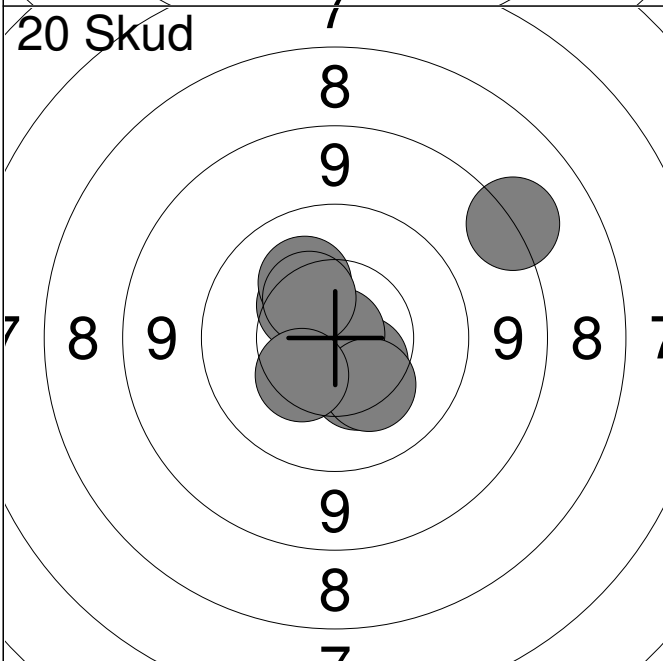

| | | |
|-----|-------|---|
| 11: | 10.5 | ↘ |
| 12: | *10.8 | ↖ |
| 13: | 10.4 | ↘ |
| 14: | 10.4 | ↖ |
| 15: | *10.9 | ↖ |
| 16: | 10.2 | ↖ |
| 17: | 10.4 | ↖ |
| 18: | 8.4 | ↗ |
| 19: | 10.3 | ↘ |
| 20: | 10.4 | ↙ |

| | |
|-------|-------|
| Serie | 98.0 |
| Total | 198.0 |

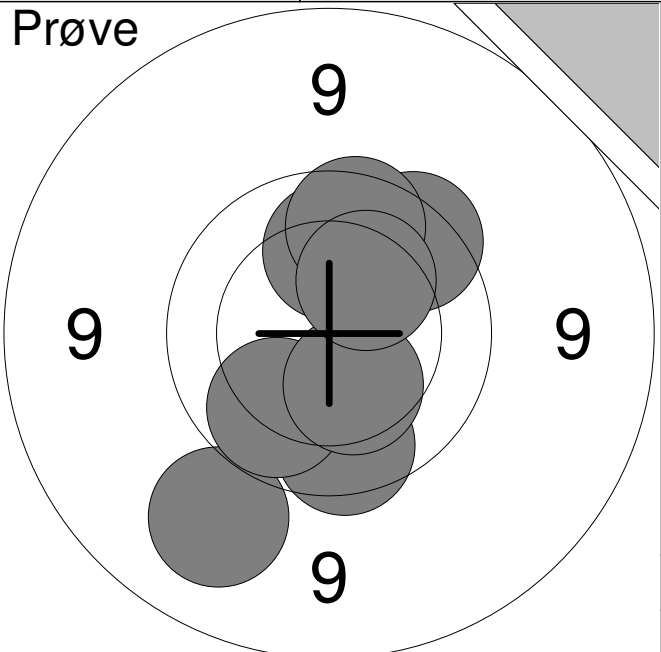
| | | | | | | | | | | | | | | | | | | | | | | | | | |
|---|--|-------|-----|------|-------|-----|-----|----|------|---|----|-----|---|----|-----|---|----|------|---|----|------|---|----|------|---|
| <p>Prøve</p>  | <table style="width:100%; border-collapse: collapse;"> <tr><td style="width:10%;">1:</td><td style="width:15%;">9.2</td><td style="width:10%; text-align: center;">↙</td></tr> <tr><td>2:</td><td>9.8</td><td style="text-align: center;">↗</td></tr> <tr><td>3:</td><td>10.1</td><td style="text-align: center;">↑</td></tr> <tr><td>4:</td><td>9.8</td><td style="text-align: center;">↑</td></tr> <tr><td>5:</td><td>9.8</td><td style="text-align: center;">↓</td></tr> <tr><td>6:</td><td>10.0</td><td style="text-align: center;">↙</td></tr> <tr><td>7:</td><td>10.3</td><td style="text-align: center;">↓</td></tr> <tr><td>8:</td><td>10.3</td><td style="text-align: center;">↗</td></tr> </table> | 1: | 9.2 | ↙ | 2: | 9.8 | ↗ | 3: | 10.1 | ↑ | 4: | 9.8 | ↑ | 5: | 9.8 | ↓ | 6: | 10.0 | ↙ | 7: | 10.3 | ↓ | 8: | 10.3 | ↗ |
| 1: | 9.2 | ↙ | | | | | | | | | | | | | | | | | | | | | | | |
| 2: | 9.8 | ↗ | | | | | | | | | | | | | | | | | | | | | | | |
| 3: | 10.1 | ↑ | | | | | | | | | | | | | | | | | | | | | | | |
| 4: | 9.8 | ↑ | | | | | | | | | | | | | | | | | | | | | | | |
| 5: | 9.8 | ↓ | | | | | | | | | | | | | | | | | | | | | | | |
| 6: | 10.0 | ↙ | | | | | | | | | | | | | | | | | | | | | | | |
| 7: | 10.3 | ↓ | | | | | | | | | | | | | | | | | | | | | | | |
| 8: | 10.3 | ↗ | | | | | | | | | | | | | | | | | | | | | | | |
| <table style="width:100%; border-collapse: collapse;"> <tr> <td style="width:10%; text-align: left;">Serie</td> <td style="width:15%;"></td> <td style="width:10%; text-align: right;">76.0</td> </tr> <tr> <td>Total</td> <td></td> <td style="text-align: right;">0.0</td> </tr> </table> | | Serie | | 76.0 | Total | | 0.0 | | | | | | | | | | | | | | | | | | |
| Serie | | 76.0 | | | | | | | | | | | | | | | | | | | | | | | |
| Total | | 0.0 | | | | | | | | | | | | | | | | | | | | | | | |

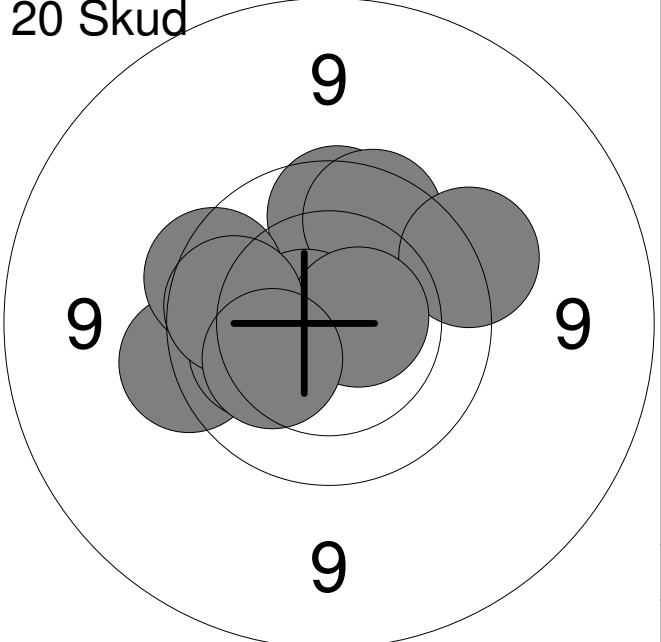
| | | | | | | | | | | | | | | | | | | | | | | | | | | | | | | | |
|--|---|-------|-----|------|-------|-----|------|----|-----|---|----|-----|---|----|-------|---|----|-----|---|----|-------|---|----|------|---|----|-----|---|-----|------|---|
| <p>20 Skud</p>  | <table style="width:100%; border-collapse: collapse;"> <tr><td style="width:10%;">1:</td><td style="width:15%;">9.9</td><td style="width:10%; text-align: center;">↑</td></tr> <tr><td>2:</td><td>9.8</td><td style="text-align: center;">↗</td></tr> <tr><td>3:</td><td>9.6</td><td style="text-align: center;">→</td></tr> <tr><td>4:</td><td>9.6</td><td style="text-align: center;">←</td></tr> <tr><td>5:</td><td>*10.7</td><td style="text-align: center;">←</td></tr> <tr><td>6:</td><td>9.8</td><td style="text-align: center;">↙</td></tr> <tr><td>7:</td><td>*10.6</td><td style="text-align: center;">→</td></tr> <tr><td>8:</td><td>10.1</td><td style="text-align: center;">←</td></tr> <tr><td>9:</td><td>9.9</td><td style="text-align: center;">←</td></tr> <tr><td>10:</td><td>10.2</td><td style="text-align: center;">↙</td></tr> </table> | 1: | 9.9 | ↑ | 2: | 9.8 | ↗ | 3: | 9.6 | → | 4: | 9.6 | ← | 5: | *10.7 | ← | 6: | 9.8 | ↙ | 7: | *10.6 | → | 8: | 10.1 | ← | 9: | 9.9 | ← | 10: | 10.2 | ↙ |
| 1: | 9.9 | ↑ | | | | | | | | | | | | | | | | | | | | | | | | | | | | | |
| 2: | 9.8 | ↗ | | | | | | | | | | | | | | | | | | | | | | | | | | | | | |
| 3: | 9.6 | → | | | | | | | | | | | | | | | | | | | | | | | | | | | | | |
| 4: | 9.6 | ← | | | | | | | | | | | | | | | | | | | | | | | | | | | | | |
| 5: | *10.7 | ← | | | | | | | | | | | | | | | | | | | | | | | | | | | | | |
| 6: | 9.8 | ↙ | | | | | | | | | | | | | | | | | | | | | | | | | | | | | |
| 7: | *10.6 | → | | | | | | | | | | | | | | | | | | | | | | | | | | | | | |
| 8: | 10.1 | ← | | | | | | | | | | | | | | | | | | | | | | | | | | | | | |
| 9: | 9.9 | ← | | | | | | | | | | | | | | | | | | | | | | | | | | | | | |
| 10: | 10.2 | ↙ | | | | | | | | | | | | | | | | | | | | | | | | | | | | | |
| <table style="width:100%; border-collapse: collapse;"> <tr> <td style="width:10%; text-align: left;">Serie</td> <td style="width:15%;"></td> <td style="width:10%; text-align: right;">94.0</td> </tr> <tr> <td>Total</td> <td></td> <td style="text-align: right;">94.0</td> </tr> </table> | | Serie | | 94.0 | Total | | 94.0 | | | | | | | | | | | | | | | | | | | | | | | | |
| Serie | | 94.0 | | | | | | | | | | | | | | | | | | | | | | | | | | | | | |
| Total | | 94.0 | | | | | | | | | | | | | | | | | | | | | | | | | | | | | |

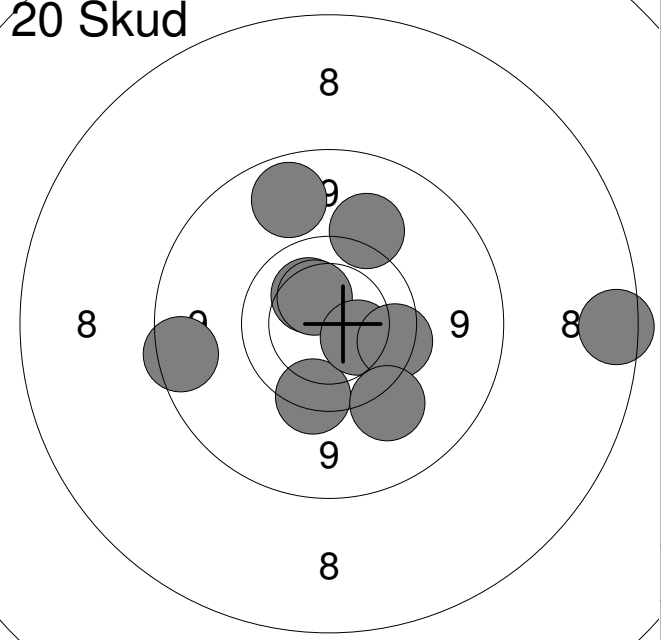
| | | | | | | | | | | | | | | | | | | | | | | | | | | | | | | | |
|---|---|-------|------|------|-------|-----|-------|-----|------|---|-----|-----|---|-----|------|---|-----|-----|---|-----|-----|---|-----|-----|---|-----|-----|---|-----|-----|---|
| <p>20 Skud</p>  | <table style="width:100%; border-collapse: collapse;"> <tr><td style="width:10%;">11:</td><td style="width:15%;">10.2</td><td style="width:10%; text-align: center;">↗</td></tr> <tr><td>12:</td><td>9.7</td><td style="text-align: center;">↓</td></tr> <tr><td>13:</td><td>10.3</td><td style="text-align: center;">↗</td></tr> <tr><td>14:</td><td>9.4</td><td style="text-align: center;">↗</td></tr> <tr><td>15:</td><td>10.3</td><td style="text-align: center;">↘</td></tr> <tr><td>16:</td><td>7.8</td><td style="text-align: center;">→</td></tr> <tr><td>17:</td><td>9.7</td><td style="text-align: center;">→</td></tr> <tr><td>18:</td><td>9.4</td><td style="text-align: center;">↓</td></tr> <tr><td>19:</td><td>8.8</td><td style="text-align: center;">←</td></tr> <tr><td>20:</td><td>9.0</td><td style="text-align: center;">↑</td></tr> </table> | 11: | 10.2 | ↗ | 12: | 9.7 | ↓ | 13: | 10.3 | ↗ | 14: | 9.4 | ↗ | 15: | 10.3 | ↘ | 16: | 7.8 | → | 17: | 9.7 | → | 18: | 9.4 | ↓ | 19: | 8.8 | ← | 20: | 9.0 | ↑ |
| 11: | 10.2 | ↗ | | | | | | | | | | | | | | | | | | | | | | | | | | | | | |
| 12: | 9.7 | ↓ | | | | | | | | | | | | | | | | | | | | | | | | | | | | | |
| 13: | 10.3 | ↗ | | | | | | | | | | | | | | | | | | | | | | | | | | | | | |
| 14: | 9.4 | ↗ | | | | | | | | | | | | | | | | | | | | | | | | | | | | | |
| 15: | 10.3 | ↘ | | | | | | | | | | | | | | | | | | | | | | | | | | | | | |
| 16: | 7.8 | → | | | | | | | | | | | | | | | | | | | | | | | | | | | | | |
| 17: | 9.7 | → | | | | | | | | | | | | | | | | | | | | | | | | | | | | | |
| 18: | 9.4 | ↓ | | | | | | | | | | | | | | | | | | | | | | | | | | | | | |
| 19: | 8.8 | ← | | | | | | | | | | | | | | | | | | | | | | | | | | | | | |
| 20: | 9.0 | ↑ | | | | | | | | | | | | | | | | | | | | | | | | | | | | | |
| <table style="width:100%; border-collapse: collapse;"> <tr> <td style="width:10%; text-align: left;">Serie</td> <td style="width:15%;"></td> <td style="width:10%; text-align: right;">90.0</td> </tr> <tr> <td>Total</td> <td></td> <td style="text-align: right;">184.0</td> </tr> </table> | | Serie | | 90.0 | Total | | 184.0 | | | | | | | | | | | | | | | | | | | | | | | | |
| Serie | | 90.0 | | | | | | | | | | | | | | | | | | | | | | | | | | | | | |
| Total | | 184.0 | | | | | | | | | | | | | | | | | | | | | | | | | | | | | |

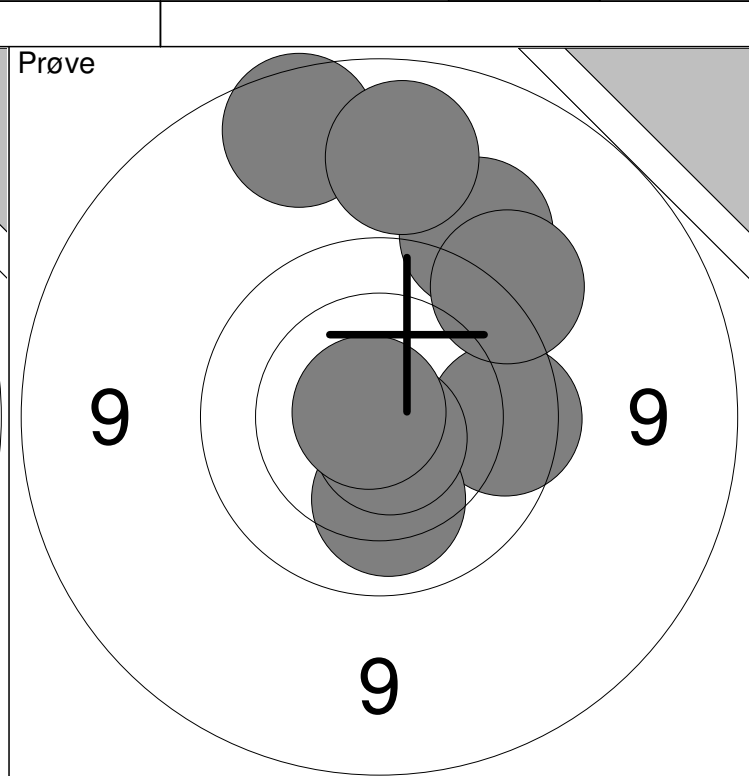
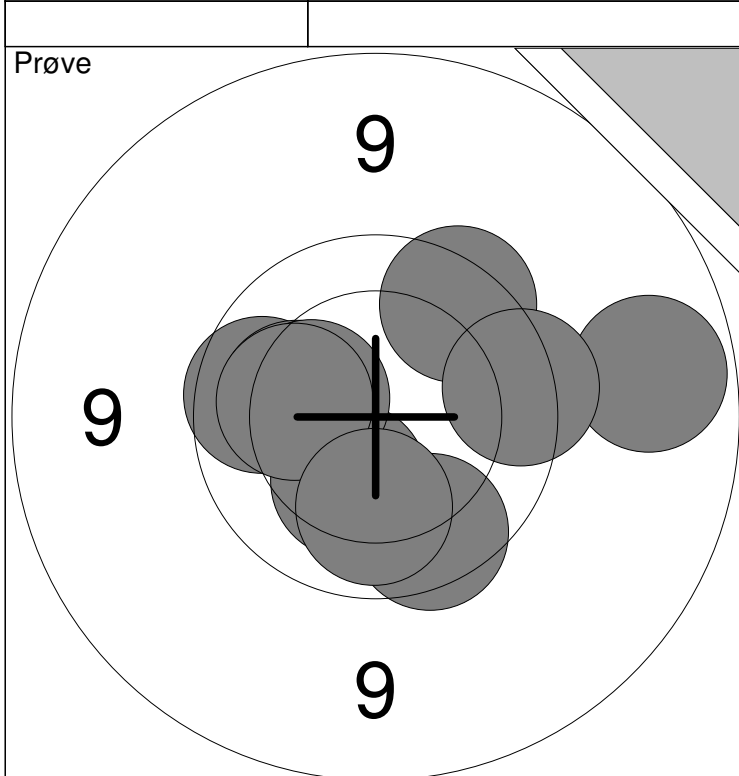

| | | | |
|-----------|-----------|-------|------|
| 1: 9.8 ↓ | 6: 9.8 ↗ | Serie | 95.0 |
| 2: 9.9 ← | 7: 10.2 ← | | |
| 3: 10.3 ↓ | 8: 10.1 ↓ | Total | 0.0 |
| 4: 10.2 ← | 9: 9.0 → | | |
| 5: 10.3 ← | 10: 9.7 → | | |

| | | | |
|------------|-------------|-------|------|
| 11: 9.8 → | 16: 9.1 ↑ | Serie | 74.0 |
| 12: 9.4 ↗ | 17: *10.7 ↓ | | |
| 13: 8.9 ↗ | 18: *10.8 ← | Total | 0.0 |
| 14: 9.5 ↗ | | | |
| 15: 10.1 ↓ | | | |

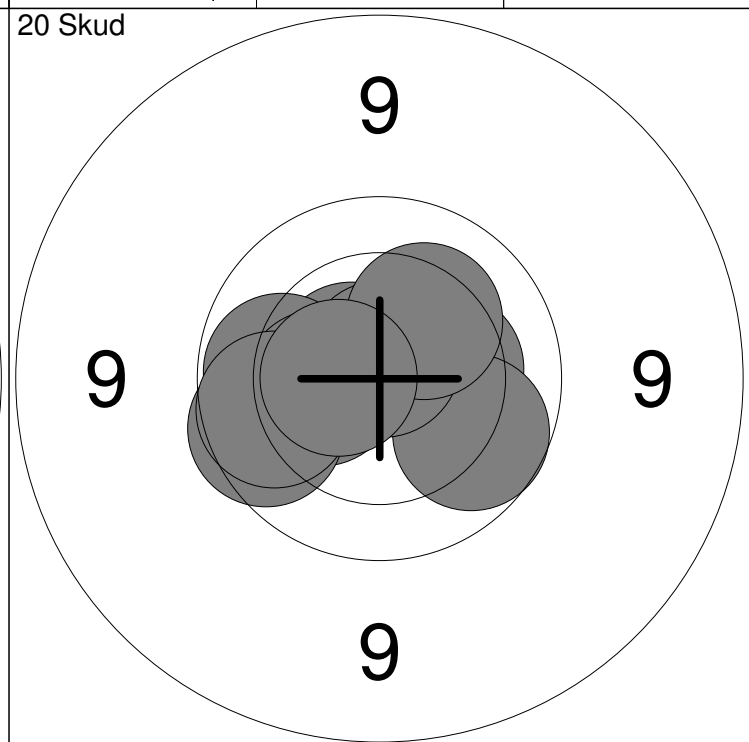
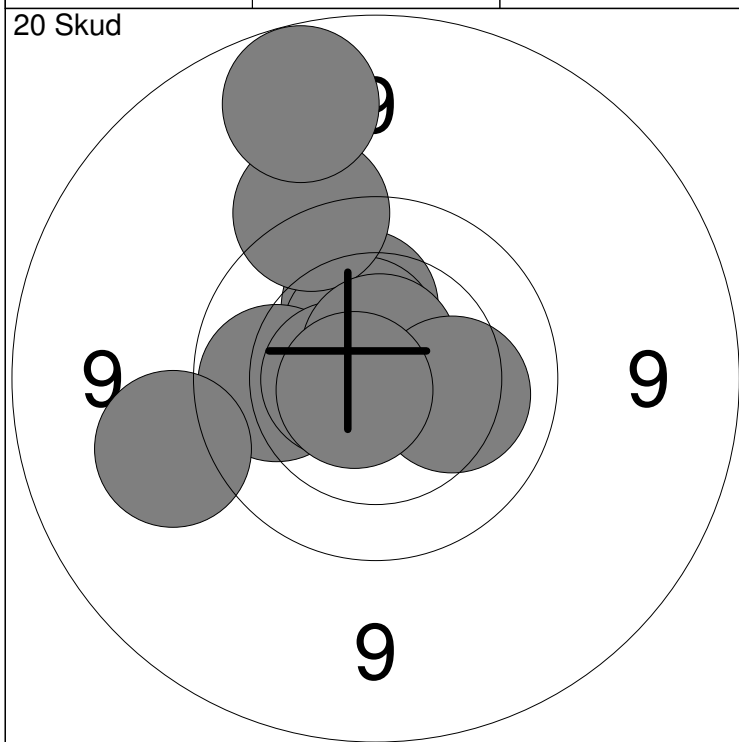

| | | | |
|------------|-------------|-------|------|
| 1: 10.2 ↑ | 6: *10.6 ← | Serie | 97.0 |
| 2: *10.5 ↑ | 7: *10.7 ↑ | | |
| 3: 9.5 ↑ | 8: 10.2 → | Total | 97.0 |
| 4: 10.0 ← | 9: 9.3 ← | | |
| 5: 9.0 ↑ | 10: *10.7 ← | | |

| | | | |
|-------------|-------------|-------|-------|
| 11: 10.3 → | 16: 9.8 ← | Serie | 97.0 |
| 12: *10.6 ↗ | 17: 9.9 ← | | |
| 13: 10.0 ← | 18: *10.8 ↑ | Total | 194.0 |
| 14: 9.9 ↘ | 19: 10.2 ↗ | | |
| 15: 10.4 ← | 20: *10.6 ← | | |

| | | | | | | | | | | | | | | | | | | | | | | | | | |
|---------------------|--|----|-----|---|----|-----|---|----|------|---|----|-----|---|----|------|---|----|------|---|----|------|---|----|-------|---|
| <p>Prøve</p> | <table style="width:100%; border-collapse: collapse;"> <tr><td style="width:10%;">1:</td><td style="width:10%;">8.9</td><td style="width:10%; text-align: right;">↘</td></tr> <tr><td>2:</td><td>8.9</td><td style="text-align: right;">↘</td></tr> <tr><td>3:</td><td>10.4</td><td style="text-align: right;">→</td></tr> <tr><td>4:</td><td>9.4</td><td style="text-align: right;">↙</td></tr> <tr><td>5:</td><td>10.2</td><td style="text-align: right;">↘</td></tr> <tr><td>6:</td><td>10.4</td><td style="text-align: right;">↙</td></tr> <tr><td>7:</td><td>10.5</td><td style="text-align: right;">↘</td></tr> <tr><td>8:</td><td>*10.7</td><td style="text-align: right;">↗</td></tr> </table> | 1: | 8.9 | ↘ | 2: | 8.9 | ↘ | 3: | 10.4 | → | 4: | 9.4 | ↙ | 5: | 10.2 | ↘ | 6: | 10.4 | ↙ | 7: | 10.5 | ↘ | 8: | *10.7 | ↗ |
| 1: | 8.9 | ↘ | | | | | | | | | | | | | | | | | | | | | | | |
| 2: | 8.9 | ↘ | | | | | | | | | | | | | | | | | | | | | | | |
| 3: | 10.4 | → | | | | | | | | | | | | | | | | | | | | | | | |
| 4: | 9.4 | ↙ | | | | | | | | | | | | | | | | | | | | | | | |
| 5: | 10.2 | ↘ | | | | | | | | | | | | | | | | | | | | | | | |
| 6: | 10.4 | ↙ | | | | | | | | | | | | | | | | | | | | | | | |
| 7: | 10.5 | ↘ | | | | | | | | | | | | | | | | | | | | | | | |
| 8: | *10.7 | ↗ | | | | | | | | | | | | | | | | | | | | | | | |

| | |
|-------|------|
| Serie | 75.0 |
|-------|------|

| | |
|-------|-----|
| Total | 0.0 |
|-------|-----|

| | | | | | | | | | | | | | | | | | | | | | | | | | | | | | | | |
|-----------------------|--|----|------|---|----|-----|---|----|------|---|----|------|---|----|-------|---|----|------|---|----|------|---|----|------|---|----|------|---|-----|-------|---|
| <p>20 Skud</p> | <table style="width:100%; border-collapse: collapse;"> <tr><td style="width:10%;">1:</td><td style="width:10%;">10.4</td><td style="width:10%; text-align: right;">↘</td></tr> <tr><td>2:</td><td>9.9</td><td style="text-align: right;">↘</td></tr> <tr><td>3:</td><td>10.5</td><td style="text-align: right;">↙</td></tr> <tr><td>4:</td><td>10.3</td><td style="text-align: right;">↗</td></tr> <tr><td>5:</td><td>*10.6</td><td style="text-align: right;">↗</td></tr> <tr><td>6:</td><td>10.0</td><td style="text-align: right;">↙</td></tr> <tr><td>7:</td><td>10.4</td><td style="text-align: right;">↗</td></tr> <tr><td>8:</td><td>10.4</td><td style="text-align: right;">↙</td></tr> <tr><td>9:</td><td>10.4</td><td style="text-align: right;">↗</td></tr> <tr><td>10:</td><td>*10.6</td><td style="text-align: right;">↘</td></tr> </table> | 1: | 10.4 | ↘ | 2: | 9.9 | ↘ | 3: | 10.5 | ↙ | 4: | 10.3 | ↗ | 5: | *10.6 | ↗ | 6: | 10.0 | ↙ | 7: | 10.4 | ↗ | 8: | 10.4 | ↙ | 9: | 10.4 | ↗ | 10: | *10.6 | ↘ |
| 1: | 10.4 | ↘ | | | | | | | | | | | | | | | | | | | | | | | | | | | | | |
| 2: | 9.9 | ↘ | | | | | | | | | | | | | | | | | | | | | | | | | | | | | |
| 3: | 10.5 | ↙ | | | | | | | | | | | | | | | | | | | | | | | | | | | | | |
| 4: | 10.3 | ↗ | | | | | | | | | | | | | | | | | | | | | | | | | | | | | |
| 5: | *10.6 | ↗ | | | | | | | | | | | | | | | | | | | | | | | | | | | | | |
| 6: | 10.0 | ↙ | | | | | | | | | | | | | | | | | | | | | | | | | | | | | |
| 7: | 10.4 | ↗ | | | | | | | | | | | | | | | | | | | | | | | | | | | | | |
| 8: | 10.4 | ↙ | | | | | | | | | | | | | | | | | | | | | | | | | | | | | |
| 9: | 10.4 | ↗ | | | | | | | | | | | | | | | | | | | | | | | | | | | | | |
| 10: | *10.6 | ↘ | | | | | | | | | | | | | | | | | | | | | | | | | | | | | |

| | |
|-------|------|
| Serie | 99.0 |
|-------|------|

| | |
|-------|------|
| Total | 99.0 |
|-------|------|

| | | | | | | | | | | | | | | | | | | | | | | | | | | | | | | | |
|-----------------------|---|-----|------|---|-----|------|---|-----|------|---|-----|-------|---|-----|-----|---|-----|------|---|-----|------|---|-----|------|---|-----|------|---|-----|-----|---|
| <p>20 Skud</p> | <table style="width:100%; border-collapse: collapse;"> <tr><td style="width:10%;">11:</td><td style="width:10%;">10.5</td><td style="width:10%; text-align: right;">→</td></tr> <tr><td>12:</td><td>10.5</td><td style="text-align: right;">↘</td></tr> <tr><td>13:</td><td>10.0</td><td style="text-align: right;">↘</td></tr> <tr><td>14:</td><td>*10.8</td><td style="text-align: right;">↗</td></tr> <tr><td>15:</td><td>9.1</td><td style="text-align: right;">→</td></tr> <tr><td>16:</td><td>10.3</td><td style="text-align: right;">↘</td></tr> <tr><td>17:</td><td>10.2</td><td style="text-align: right;">↙</td></tr> <tr><td>18:</td><td>10.0</td><td style="text-align: right;">↙</td></tr> <tr><td>19:</td><td>10.1</td><td style="text-align: right;">↗</td></tr> <tr><td>20:</td><td>9.4</td><td style="text-align: right;">↙</td></tr> </table> | 11: | 10.5 | → | 12: | 10.5 | ↘ | 13: | 10.0 | ↘ | 14: | *10.8 | ↗ | 15: | 9.1 | → | 16: | 10.3 | ↘ | 17: | 10.2 | ↙ | 18: | 10.0 | ↙ | 19: | 10.1 | ↗ | 20: | 9.4 | ↙ |
| 11: | 10.5 | → | | | | | | | | | | | | | | | | | | | | | | | | | | | | | |
| 12: | 10.5 | ↘ | | | | | | | | | | | | | | | | | | | | | | | | | | | | | |
| 13: | 10.0 | ↘ | | | | | | | | | | | | | | | | | | | | | | | | | | | | | |
| 14: | *10.8 | ↗ | | | | | | | | | | | | | | | | | | | | | | | | | | | | | |
| 15: | 9.1 | → | | | | | | | | | | | | | | | | | | | | | | | | | | | | | |
| 16: | 10.3 | ↘ | | | | | | | | | | | | | | | | | | | | | | | | | | | | | |
| 17: | 10.2 | ↙ | | | | | | | | | | | | | | | | | | | | | | | | | | | | | |
| 18: | 10.0 | ↙ | | | | | | | | | | | | | | | | | | | | | | | | | | | | | |
| 19: | 10.1 | ↗ | | | | | | | | | | | | | | | | | | | | | | | | | | | | | |
| 20: | 9.4 | ↙ | | | | | | | | | | | | | | | | | | | | | | | | | | | | | |

| | |
|-------|------|
| Serie | 98.0 |
|-------|------|

| | |
|-------|-------|
| Total | 197.0 |
|-------|-------|

Hold
28

Skive
6

Rasmus Klitgaard

Hjørring Skytteforening

J2

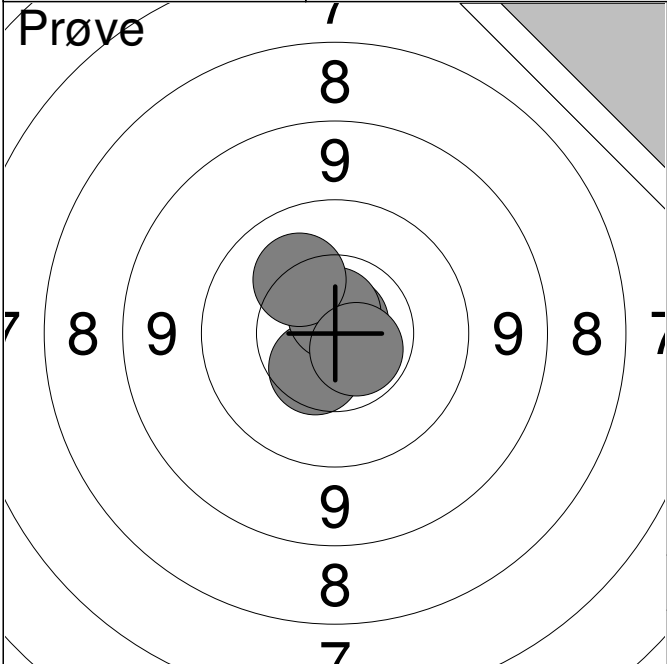

| | | |
|----|-------|---|
| 1: | *10.8 | ↗ |
| 2: | 10.5 | ↘ |
| 3: | *10.7 | ↑ |
| 4: | 10.2 | ↗ |
| 5: | *10.6 | ↘ |

| | |
|-------|------|
| Serie | 50.0 |
| Total | 0.0 |

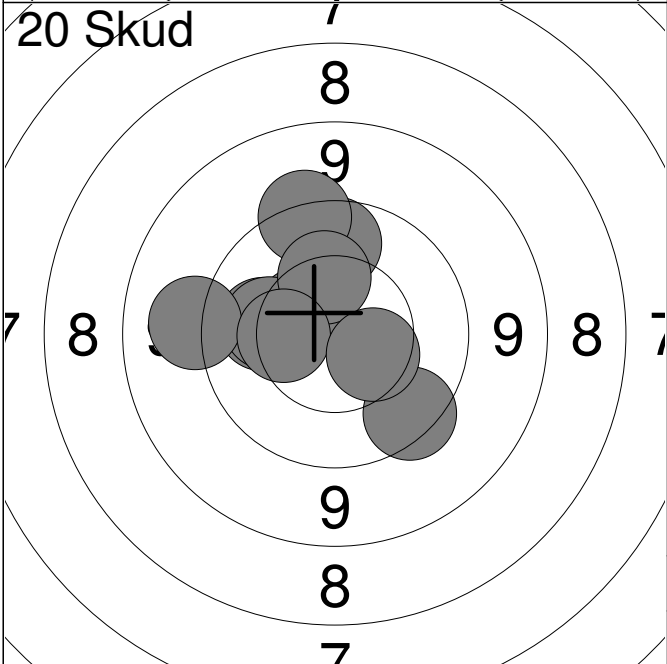

| | | |
|-----|------|---|
| 1: | 9.9 | ↑ |
| 2: | 9.5 | ↑ |
| 3: | 10.5 | ↗ |
| 4: | 10.1 | ← |
| 5: | 10.2 | ← |
| 6: | 9.3 | ← |
| 7: | 10.3 | ↑ |
| 8: | 9.7 | ↘ |
| 9: | 10.4 | ← |
| 10: | 10.5 | ↘ |

| | |
|-------|------|
| Serie | 96.0 |
| Total | 96.0 |

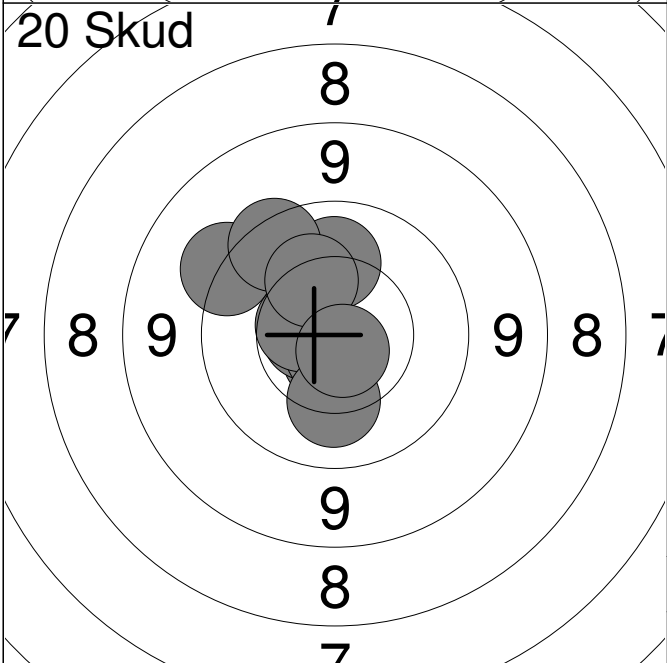

| | | |
|-----|-------|---|
| 11: | 10.1 | ↑ |
| 12: | *10.7 | ↘ |
| 13: | 9.4 | ↗ |
| 14: | *10.6 | ← |
| 15: | *10.8 | ↘ |
| 16: | 9.7 | ↗ |
| 17: | 10.5 | ↑ |
| 18: | 10.3 | ↗ |
| 19: | 10.2 | ↘ |
| 20: | *10.8 | ↘ |

| | |
|-------|-------|
| Serie | 98.0 |
| Total | 194.0 |

Hold
28Skive
7

Mathias Haugaard Mikkelsen

Hjørring Skytteforening

MB2

Prøve

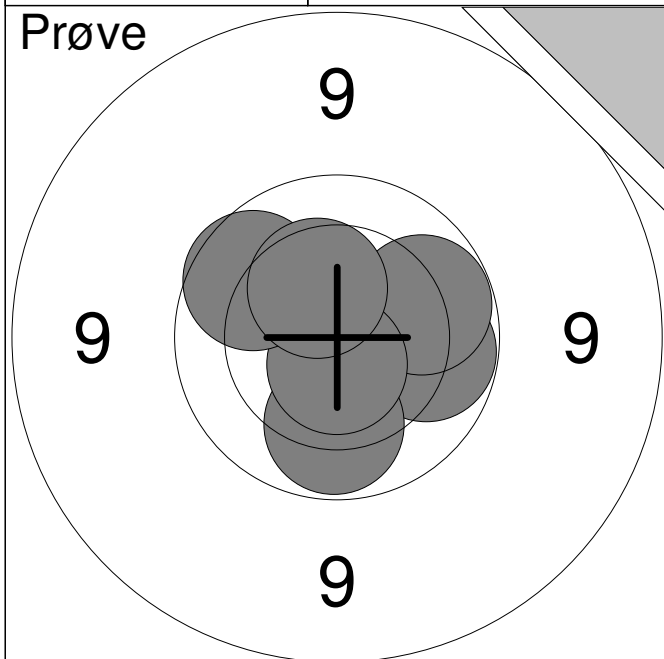

| | | |
|----|-------|---|
| 1: | 10.0 | → |
| 2: | 10.0 | ↓ |
| 3: | 10.0 | → |
| 4: | *10.7 | ↓ |
| 5: | 9.9 | ↗ |
| 6: | 10.4 | ↗ |

Serie 59.0

Total 0.0

20 Skud

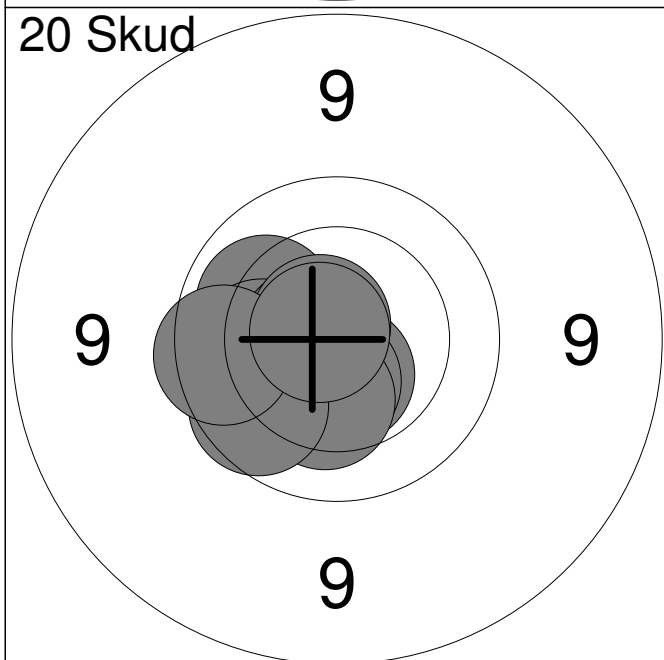

| | | |
|-----|-------|---|
| 1: | *10.6 | ↓ |
| 2: | 10.1 | ↗ |
| 3: | 10.5 | ↓ |
| 4: | 10.1 | ← |
| 5: | *10.6 | ← |
| 6: | *10.7 | ↗ |
| 7: | 10.3 | ↓ |
| 8: | 9.9 | ↙ |
| 9: | 9.8 | ← |
| 10: | *10.7 | ↗ |

Serie 98.0

Total 98.0

20 Skud

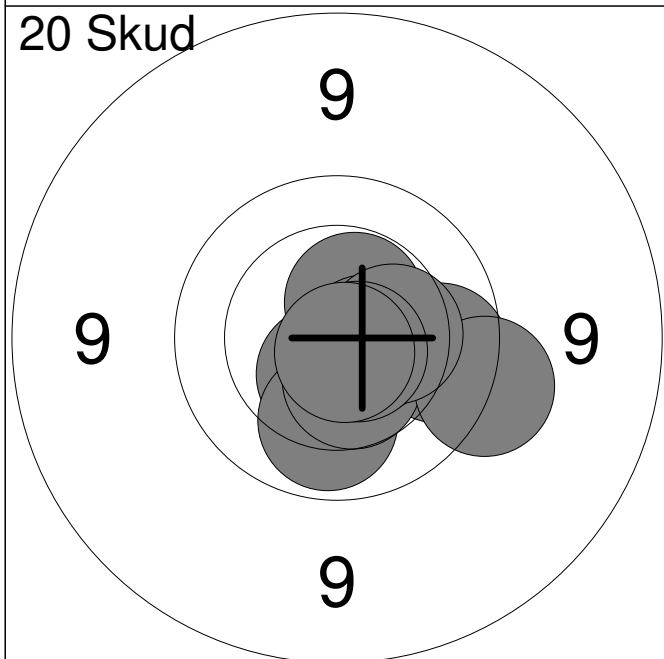

| | | |
|-----|-------|---|
| 11: | *10.5 | ↓ |
| 12: | 9.9 | → |
| 13: | 10.1 | ↓ |
| 14: | 10.5 | ↓ |
| 15: | *10.5 | ↗ |
| 16: | *10.6 | → |
| 17: | 9.6 | → |
| 18: | 10.3 | → |
| 19: | *10.7 | ↓ |
| 20: | *10.8 | ↓ |

Serie 98.0

Total 196.0

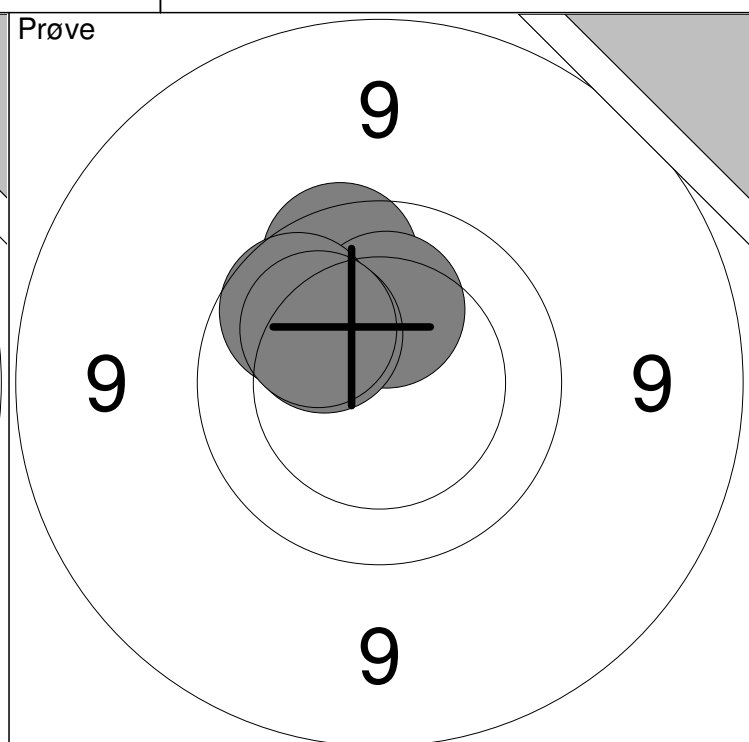
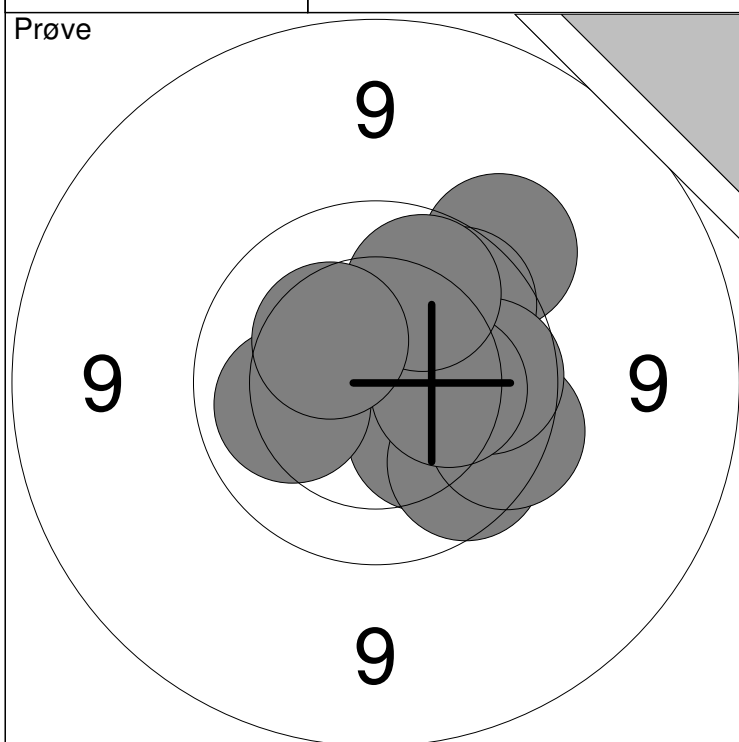

| | | | |
|-----------|------------|-------|------|
| 1: 10.3 ↘ | 6: 9.9 ↗ | Serie | 95.0 |
| 2: 9.9 ↘ | 7: 9.9 → | | |
| 3: 9.8 ↘ | 8: 10.2 → | Total | 0.0 |
| 4: 10.1 ← | 9: 10.0 ↗ | | |
| 5: 9.5 ↗ | 10: 10.4 ↖ | | |

| | | |
|------------|-------|------|
| 11: 9.8 ↗ | Serie | 48.0 |
| 12: 10.2 ↗ | | |
| 13: 9.9 ↘ | Total | 0.0 |
| 14: 10.2 ↗ | | |
| 15: 10.2 ↗ | | |

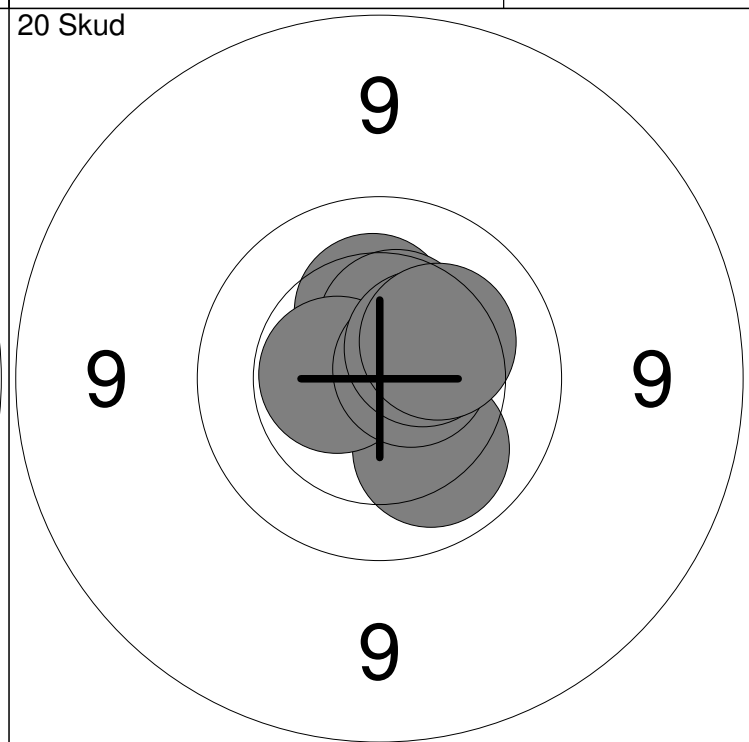
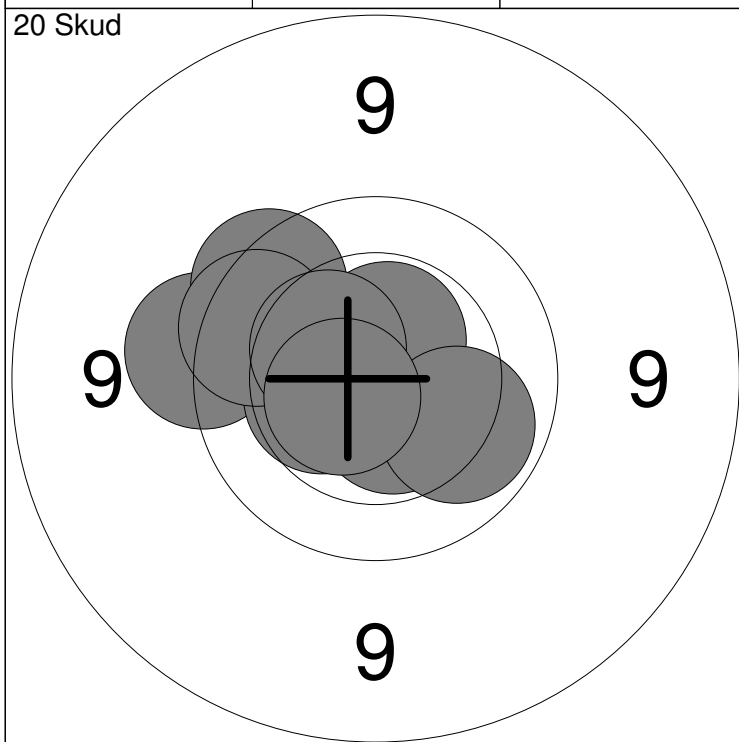

| | | | |
|------------|-------------|-------|------|
| 1: 9.6 ← | 6: *10.6 ↘ | Serie | 97.0 |
| 2: 9.7 ↗ | 7: *10.6 ↗ | | |
| 3: 10.4 ← | 8: 10.4 ↖ | Total | 97.0 |
| 4: *10.8 ↗ | 9: 10.1 ↘ | | |
| 5: 9.8 ← | 10: *10.6 ↖ | | |

| | | | |
|-------------|-------------|-------|-------|
| 11: 10.4 ↗ | 16: 10.1 ↘ | Serie | 100.0 |
| 12: *10.7 → | 17: *10.5 ← | | |
| 13: 10.3 ↗ | 18: *10.6 → | Total | 197.0 |
| 14: 10.5 ↗ | 19: 10.4 ↗ | | |
| 15: 10.4 ↗ | 20: 10.3 ↗ | | |

| | | | | | | | | | | | | | | | | | | | | |
|---------------------|--|----|-----|---|----|------|---|----|------|---|----|-------|---|----|------|---|-------|------|-------|-----|
| <p>Prøve</p> | <table style="width:100%; border-collapse: collapse;"> <tr><td style="width:10%;">1:</td><td style="width:20%;">9.7</td><td style="width:10%; text-align: right;">↓</td></tr> <tr><td>2:</td><td>10.0</td><td style="text-align: right;">↓</td></tr> <tr><td>3:</td><td>10.0</td><td style="text-align: right;">←</td></tr> <tr><td>4:</td><td>*10.7</td><td style="text-align: right;">↓</td></tr> <tr><td>5:</td><td>10.4</td><td style="text-align: right;">↙</td></tr> </table> <table border="1" style="width:100%; border-collapse: collapse; margin-top: 5px;"> <tr> <td style="width:80%;">Serie</td> <td style="width:20%; text-align: right;">49.0</td> </tr> <tr> <td>Total</td> <td style="text-align: right;">0.0</td> </tr> </table> | 1: | 9.7 | ↓ | 2: | 10.0 | ↓ | 3: | 10.0 | ← | 4: | *10.7 | ↓ | 5: | 10.4 | ↙ | Serie | 49.0 | Total | 0.0 |
| 1: | 9.7 | ↓ | | | | | | | | | | | | | | | | | | |
| 2: | 10.0 | ↓ | | | | | | | | | | | | | | | | | | |
| 3: | 10.0 | ← | | | | | | | | | | | | | | | | | | |
| 4: | *10.7 | ↓ | | | | | | | | | | | | | | | | | | |
| 5: | 10.4 | ↙ | | | | | | | | | | | | | | | | | | |
| Serie | 49.0 | | | | | | | | | | | | | | | | | | | |
| Total | 0.0 | | | | | | | | | | | | | | | | | | | |

| | | | | | | | | | | | | | | | | | | | | | | | | | | | | | | | | | | | |
|-----------------------|---|----|-------|---|----|-------|---|----|-------|---|----|------|---|----|-------|---|----|-----|---|----|-----|---|----|------|---|----|-------|---|-----|-----|---|-------|------|-------|------|
| <p>20 Skud</p> | <table style="width:100%; border-collapse: collapse;"> <tr><td style="width:10%;">1:</td><td style="width:20%;">*10.8</td><td style="width:10%; text-align: right;">→</td></tr> <tr><td>2:</td><td>*10.5</td><td style="text-align: right;">↑</td></tr> <tr><td>3:</td><td>*10.5</td><td style="text-align: right;">↗</td></tr> <tr><td>4:</td><td>10.1</td><td style="text-align: right;">↑</td></tr> <tr><td>5:</td><td>*10.7</td><td style="text-align: right;">↑</td></tr> <tr><td>6:</td><td>9.9</td><td style="text-align: right;">↖</td></tr> <tr><td>7:</td><td>9.4</td><td style="text-align: right;">↑</td></tr> <tr><td>8:</td><td>10.3</td><td style="text-align: right;">↑</td></tr> <tr><td>9:</td><td>*10.7</td><td style="text-align: right;">↙</td></tr> <tr><td>10:</td><td>9.9</td><td style="text-align: right;">←</td></tr> </table> <table border="1" style="width:100%; border-collapse: collapse; margin-top: 5px;"> <tr> <td style="width:80%;">Serie</td> <td style="width:20%; text-align: right;">97.0</td> </tr> <tr> <td>Total</td> <td style="text-align: right;">97.0</td> </tr> </table> | 1: | *10.8 | → | 2: | *10.5 | ↑ | 3: | *10.5 | ↗ | 4: | 10.1 | ↑ | 5: | *10.7 | ↑ | 6: | 9.9 | ↖ | 7: | 9.4 | ↑ | 8: | 10.3 | ↑ | 9: | *10.7 | ↙ | 10: | 9.9 | ← | Serie | 97.0 | Total | 97.0 |
| 1: | *10.8 | → | | | | | | | | | | | | | | | | | | | | | | | | | | | | | | | | | |
| 2: | *10.5 | ↑ | | | | | | | | | | | | | | | | | | | | | | | | | | | | | | | | | |
| 3: | *10.5 | ↗ | | | | | | | | | | | | | | | | | | | | | | | | | | | | | | | | | |
| 4: | 10.1 | ↑ | | | | | | | | | | | | | | | | | | | | | | | | | | | | | | | | | |
| 5: | *10.7 | ↑ | | | | | | | | | | | | | | | | | | | | | | | | | | | | | | | | | |
| 6: | 9.9 | ↖ | | | | | | | | | | | | | | | | | | | | | | | | | | | | | | | | | |
| 7: | 9.4 | ↑ | | | | | | | | | | | | | | | | | | | | | | | | | | | | | | | | | |
| 8: | 10.3 | ↑ | | | | | | | | | | | | | | | | | | | | | | | | | | | | | | | | | |
| 9: | *10.7 | ↙ | | | | | | | | | | | | | | | | | | | | | | | | | | | | | | | | | |
| 10: | 9.9 | ← | | | | | | | | | | | | | | | | | | | | | | | | | | | | | | | | | |
| Serie | 97.0 | | | | | | | | | | | | | | | | | | | | | | | | | | | | | | | | | | |
| Total | 97.0 | | | | | | | | | | | | | | | | | | | | | | | | | | | | | | | | | | |

| | | | | | | | | | | | | | | | | | | | | | | | | | | | | | | | | | | | |
|-----------------------|---|-----|------|---|-----|-------|---|-----|------|---|-----|------|---|-----|------|---|-----|-----|---|-----|-------|---|-----|-----|---|-----|-----|---|-----|-------|---|-------|------|-------|-------|
| <p>20 Skud</p> | <table style="width:100%; border-collapse: collapse;"> <tr><td style="width:10%;">11:</td><td style="width:20%;">10.4</td><td style="width:10%; text-align: right;">←</td></tr> <tr><td>12:</td><td>*10.8</td><td style="text-align: right;">↙</td></tr> <tr><td>13:</td><td>10.1</td><td style="text-align: right;">↓</td></tr> <tr><td>14:</td><td>10.4</td><td style="text-align: right;">↓</td></tr> <tr><td>15:</td><td>10.4</td><td style="text-align: right;">↑</td></tr> <tr><td>16:</td><td>9.9</td><td style="text-align: right;">↖</td></tr> <tr><td>17:</td><td>*10.7</td><td style="text-align: right;">↗</td></tr> <tr><td>18:</td><td>9.9</td><td style="text-align: right;">↓</td></tr> <tr><td>19:</td><td>9.5</td><td style="text-align: right;">↙</td></tr> <tr><td>20:</td><td>*10.7</td><td style="text-align: right;">↓</td></tr> </table> <table border="1" style="width:100%; border-collapse: collapse; margin-top: 5px;"> <tr> <td style="width:80%;">Serie</td> <td style="width:20%; text-align: right;">97.0</td> </tr> <tr> <td>Total</td> <td style="text-align: right;">194.0</td> </tr> </table> | 11: | 10.4 | ← | 12: | *10.8 | ↙ | 13: | 10.1 | ↓ | 14: | 10.4 | ↓ | 15: | 10.4 | ↑ | 16: | 9.9 | ↖ | 17: | *10.7 | ↗ | 18: | 9.9 | ↓ | 19: | 9.5 | ↙ | 20: | *10.7 | ↓ | Serie | 97.0 | Total | 194.0 |
| 11: | 10.4 | ← | | | | | | | | | | | | | | | | | | | | | | | | | | | | | | | | | |
| 12: | *10.8 | ↙ | | | | | | | | | | | | | | | | | | | | | | | | | | | | | | | | | |
| 13: | 10.1 | ↓ | | | | | | | | | | | | | | | | | | | | | | | | | | | | | | | | | |
| 14: | 10.4 | ↓ | | | | | | | | | | | | | | | | | | | | | | | | | | | | | | | | | |
| 15: | 10.4 | ↑ | | | | | | | | | | | | | | | | | | | | | | | | | | | | | | | | | |
| 16: | 9.9 | ↖ | | | | | | | | | | | | | | | | | | | | | | | | | | | | | | | | | |
| 17: | *10.7 | ↗ | | | | | | | | | | | | | | | | | | | | | | | | | | | | | | | | | |
| 18: | 9.9 | ↓ | | | | | | | | | | | | | | | | | | | | | | | | | | | | | | | | | |
| 19: | 9.5 | ↙ | | | | | | | | | | | | | | | | | | | | | | | | | | | | | | | | | |
| 20: | *10.7 | ↓ | | | | | | | | | | | | | | | | | | | | | | | | | | | | | | | | | |
| Serie | 97.0 | | | | | | | | | | | | | | | | | | | | | | | | | | | | | | | | | | |
| Total | 194.0 | | | | | | | | | | | | | | | | | | | | | | | | | | | | | | | | | | |

| | | | | | | | | | | | | | | | | | | | | | | | | | | | | | |
|---------------------|--|----|------|---|----|-------|---|----|-------|---|----|------|---|----|-----|---|----|------|---|----|------|---|----|------|---|-------|------|-------|-----|
| <p>Prøve</p> | <table style="width:100%; border-collapse: collapse;"> <tr><td style="text-align: right;">1:</td><td style="text-align: right;">10.5</td><td style="text-align: right;">←</td></tr> <tr><td style="text-align: right;">2:</td><td style="text-align: right;">*10.5</td><td style="text-align: right;">→</td></tr> <tr><td style="text-align: right;">3:</td><td style="text-align: right;">*10.5</td><td style="text-align: right;">←</td></tr> <tr><td style="text-align: right;">4:</td><td style="text-align: right;">10.0</td><td style="text-align: right;">↙</td></tr> <tr><td style="text-align: right;">5:</td><td style="text-align: right;">9.9</td><td style="text-align: right;">←</td></tr> <tr><td style="text-align: right;">6:</td><td style="text-align: right;">10.1</td><td style="text-align: right;">↑</td></tr> <tr><td style="text-align: right;">7:</td><td style="text-align: right;">10.4</td><td style="text-align: right;">↖</td></tr> <tr><td style="text-align: right;">8:</td><td style="text-align: right;">10.4</td><td style="text-align: right;">↗</td></tr> </table> <table border="1" style="width:100%; border-collapse: collapse; margin-top: 5px;"> <tr> <td style="width:80%;">Serie</td> <td style="text-align: right;">79.0</td> </tr> <tr> <td>Total</td> <td style="text-align: right;">0.0</td> </tr> </table> | 1: | 10.5 | ← | 2: | *10.5 | → | 3: | *10.5 | ← | 4: | 10.0 | ↙ | 5: | 9.9 | ← | 6: | 10.1 | ↑ | 7: | 10.4 | ↖ | 8: | 10.4 | ↗ | Serie | 79.0 | Total | 0.0 |
| 1: | 10.5 | ← | | | | | | | | | | | | | | | | | | | | | | | | | | | |
| 2: | *10.5 | → | | | | | | | | | | | | | | | | | | | | | | | | | | | |
| 3: | *10.5 | ← | | | | | | | | | | | | | | | | | | | | | | | | | | | |
| 4: | 10.0 | ↙ | | | | | | | | | | | | | | | | | | | | | | | | | | | |
| 5: | 9.9 | ← | | | | | | | | | | | | | | | | | | | | | | | | | | | |
| 6: | 10.1 | ↑ | | | | | | | | | | | | | | | | | | | | | | | | | | | |
| 7: | 10.4 | ↖ | | | | | | | | | | | | | | | | | | | | | | | | | | | |
| 8: | 10.4 | ↗ | | | | | | | | | | | | | | | | | | | | | | | | | | | |
| Serie | 79.0 | | | | | | | | | | | | | | | | | | | | | | | | | | | | |
| Total | 0.0 | | | | | | | | | | | | | | | | | | | | | | | | | | | | |

| | | | | | | | | | | | | | | | | | | | | | | | | | | | | | | | | | | | |
|-----------------------|---|----|------|---|----|-----|---|----|-------|---|----|------|---|----|------|---|----|-------|---|----|-----|---|----|-------|---|----|------|---|-----|-------|---|-------|------|-------|------|
| <p>20 Skud</p> | <table style="width:100%; border-collapse: collapse;"> <tr><td style="text-align: right;">1:</td><td style="text-align: right;">10.4</td><td style="text-align: right;">↘</td></tr> <tr><td style="text-align: right;">2:</td><td style="text-align: right;">9.8</td><td style="text-align: right;">↙</td></tr> <tr><td style="text-align: right;">3:</td><td style="text-align: right;">*10.8</td><td style="text-align: right;">↘</td></tr> <tr><td style="text-align: right;">4:</td><td style="text-align: right;">10.1</td><td style="text-align: right;">↘</td></tr> <tr><td style="text-align: right;">5:</td><td style="text-align: right;">10.2</td><td style="text-align: right;">←</td></tr> <tr><td style="text-align: right;">6:</td><td style="text-align: right;">*10.6</td><td style="text-align: right;">↘</td></tr> <tr><td style="text-align: right;">7:</td><td style="text-align: right;">9.9</td><td style="text-align: right;">←</td></tr> <tr><td style="text-align: right;">8:</td><td style="text-align: right;">*10.6</td><td style="text-align: right;">↙</td></tr> <tr><td style="text-align: right;">9:</td><td style="text-align: right;">10.1</td><td style="text-align: right;">↘</td></tr> <tr><td style="text-align: right;">10:</td><td style="text-align: right;">*10.8</td><td style="text-align: right;">↘</td></tr> </table> <table border="1" style="width:100%; border-collapse: collapse; margin-top: 5px;"> <tr> <td style="width:80%;">Serie</td> <td style="text-align: right;">98.0</td> </tr> <tr> <td>Total</td> <td style="text-align: right;">98.0</td> </tr> </table> | 1: | 10.4 | ↘ | 2: | 9.8 | ↙ | 3: | *10.8 | ↘ | 4: | 10.1 | ↘ | 5: | 10.2 | ← | 6: | *10.6 | ↘ | 7: | 9.9 | ← | 8: | *10.6 | ↙ | 9: | 10.1 | ↘ | 10: | *10.8 | ↘ | Serie | 98.0 | Total | 98.0 |
| 1: | 10.4 | ↘ | | | | | | | | | | | | | | | | | | | | | | | | | | | | | | | | | |
| 2: | 9.8 | ↙ | | | | | | | | | | | | | | | | | | | | | | | | | | | | | | | | | |
| 3: | *10.8 | ↘ | | | | | | | | | | | | | | | | | | | | | | | | | | | | | | | | | |
| 4: | 10.1 | ↘ | | | | | | | | | | | | | | | | | | | | | | | | | | | | | | | | | |
| 5: | 10.2 | ← | | | | | | | | | | | | | | | | | | | | | | | | | | | | | | | | | |
| 6: | *10.6 | ↘ | | | | | | | | | | | | | | | | | | | | | | | | | | | | | | | | | |
| 7: | 9.9 | ← | | | | | | | | | | | | | | | | | | | | | | | | | | | | | | | | | |
| 8: | *10.6 | ↙ | | | | | | | | | | | | | | | | | | | | | | | | | | | | | | | | | |
| 9: | 10.1 | ↘ | | | | | | | | | | | | | | | | | | | | | | | | | | | | | | | | | |
| 10: | *10.8 | ↘ | | | | | | | | | | | | | | | | | | | | | | | | | | | | | | | | | |
| Serie | 98.0 | | | | | | | | | | | | | | | | | | | | | | | | | | | | | | | | | | |
| Total | 98.0 | | | | | | | | | | | | | | | | | | | | | | | | | | | | | | | | | | |

| | | | | | | | | | | | | | | | | | | | | | | | | | | | | | | | | | | | |
|-----------------------|--|-----|-------|---|-----|-------|---|-----|------|---|-----|------|---|-----|-----|---|-----|-------|---|-----|-------|---|-----|------|---|-----|-----|---|-----|-------|---|-------|------|-------|-------|
| <p>20 Skud</p> | <table style="width:100%; border-collapse: collapse;"> <tr><td style="text-align: right;">11:</td><td style="text-align: right;">*10.5</td><td style="text-align: right;">↗</td></tr> <tr><td style="text-align: right;">12:</td><td style="text-align: right;">*10.6</td><td style="text-align: right;">←</td></tr> <tr><td style="text-align: right;">13:</td><td style="text-align: right;">10.4</td><td style="text-align: right;">↙</td></tr> <tr><td style="text-align: right;">14:</td><td style="text-align: right;">10.2</td><td style="text-align: right;">↘</td></tr> <tr><td style="text-align: right;">15:</td><td style="text-align: right;">9.9</td><td style="text-align: right;">→</td></tr> <tr><td style="text-align: right;">16:</td><td style="text-align: right;">*10.5</td><td style="text-align: right;">↙</td></tr> <tr><td style="text-align: right;">17:</td><td style="text-align: right;">*10.6</td><td style="text-align: right;">→</td></tr> <tr><td style="text-align: right;">18:</td><td style="text-align: right;">10.0</td><td style="text-align: right;">↗</td></tr> <tr><td style="text-align: right;">19:</td><td style="text-align: right;">9.9</td><td style="text-align: right;">←</td></tr> <tr><td style="text-align: right;">20:</td><td style="text-align: right;">*10.8</td><td style="text-align: right;">←</td></tr> </table> <table border="1" style="width:100%; border-collapse: collapse; margin-top: 5px;"> <tr> <td style="width:80%;">Serie</td> <td style="text-align: right;">98.0</td> </tr> <tr> <td>Total</td> <td style="text-align: right;">196.0</td> </tr> </table> | 11: | *10.5 | ↗ | 12: | *10.6 | ← | 13: | 10.4 | ↙ | 14: | 10.2 | ↘ | 15: | 9.9 | → | 16: | *10.5 | ↙ | 17: | *10.6 | → | 18: | 10.0 | ↗ | 19: | 9.9 | ← | 20: | *10.8 | ← | Serie | 98.0 | Total | 196.0 |
| 11: | *10.5 | ↗ | | | | | | | | | | | | | | | | | | | | | | | | | | | | | | | | | |
| 12: | *10.6 | ← | | | | | | | | | | | | | | | | | | | | | | | | | | | | | | | | | |
| 13: | 10.4 | ↙ | | | | | | | | | | | | | | | | | | | | | | | | | | | | | | | | | |
| 14: | 10.2 | ↘ | | | | | | | | | | | | | | | | | | | | | | | | | | | | | | | | | |
| 15: | 9.9 | → | | | | | | | | | | | | | | | | | | | | | | | | | | | | | | | | | |
| 16: | *10.5 | ↙ | | | | | | | | | | | | | | | | | | | | | | | | | | | | | | | | | |
| 17: | *10.6 | → | | | | | | | | | | | | | | | | | | | | | | | | | | | | | | | | | |
| 18: | 10.0 | ↗ | | | | | | | | | | | | | | | | | | | | | | | | | | | | | | | | | |
| 19: | 9.9 | ← | | | | | | | | | | | | | | | | | | | | | | | | | | | | | | | | | |
| 20: | *10.8 | ← | | | | | | | | | | | | | | | | | | | | | | | | | | | | | | | | | |
| Serie | 98.0 | | | | | | | | | | | | | | | | | | | | | | | | | | | | | | | | | | |
| Total | 196.0 | | | | | | | | | | | | | | | | | | | | | | | | | | | | | | | | | | |

| | | | | | | | | | | | | | | | | | | | | |
|---------------------|---|----|-----|---|----|-------|---|----|------|---|----|------|---|----|-----|---|-------|------|-------|-----|
| <p>Prøve</p> | <table style="width:100%; border-collapse: collapse;"> <tr><td style="text-align: right;">1:</td><td style="text-align: right;">8.9</td><td style="text-align: right;">→</td></tr> <tr><td style="text-align: right;">2:</td><td style="text-align: right;">*10.6</td><td style="text-align: right;">←</td></tr> <tr><td style="text-align: right;">3:</td><td style="text-align: right;">10.4</td><td style="text-align: right;">↘</td></tr> <tr><td style="text-align: right;">4:</td><td style="text-align: right;">10.3</td><td style="text-align: right;">↗</td></tr> <tr><td style="text-align: right;">5:</td><td style="text-align: right;">9.6</td><td style="text-align: right;">→</td></tr> </table> <table border="1" style="width:100%; border-collapse: collapse; margin-top: 5px;"> <tr> <td style="width:80%;">Serie</td> <td style="text-align: right;">47.0</td> </tr> <tr> <td>Total</td> <td style="text-align: right;">0.0</td> </tr> </table> | 1: | 8.9 | → | 2: | *10.6 | ← | 3: | 10.4 | ↘ | 4: | 10.3 | ↗ | 5: | 9.6 | → | Serie | 47.0 | Total | 0.0 |
| 1: | 8.9 | → | | | | | | | | | | | | | | | | | | |
| 2: | *10.6 | ← | | | | | | | | | | | | | | | | | | |
| 3: | 10.4 | ↘ | | | | | | | | | | | | | | | | | | |
| 4: | 10.3 | ↗ | | | | | | | | | | | | | | | | | | |
| 5: | 9.6 | → | | | | | | | | | | | | | | | | | | |
| Serie | 47.0 | | | | | | | | | | | | | | | | | | | |
| Total | 0.0 | | | | | | | | | | | | | | | | | | | |

| | | | | | | | | | | | | | | | | | | | | | | | | | | | | | | | | | | | |
|-----------------------|---|----|-------|---|----|------|---|----|------|---|----|------|---|----|------|---|----|-------|---|----|------|---|----|-----|---|----|------|---|-----|-----|---|-------|------|-------|------|
| <p>20 Skud</p> | <table style="width:100%; border-collapse: collapse;"> <tr><td style="text-align: right;">1:</td><td style="text-align: right;">*10.8</td><td style="text-align: right;">↖</td></tr> <tr><td style="text-align: right;">2:</td><td style="text-align: right;">10.1</td><td style="text-align: right;">↗</td></tr> <tr><td style="text-align: right;">3:</td><td style="text-align: right;">10.0</td><td style="text-align: right;">↑</td></tr> <tr><td style="text-align: right;">4:</td><td style="text-align: right;">10.4</td><td style="text-align: right;">←</td></tr> <tr><td style="text-align: right;">5:</td><td style="text-align: right;">10.2</td><td style="text-align: right;">↙</td></tr> <tr><td style="text-align: right;">6:</td><td style="text-align: right;">*10.5</td><td style="text-align: right;">↘</td></tr> <tr><td style="text-align: right;">7:</td><td style="text-align: right;">10.4</td><td style="text-align: right;">↑</td></tr> <tr><td style="text-align: right;">8:</td><td style="text-align: right;">9.9</td><td style="text-align: right;">↗</td></tr> <tr><td style="text-align: right;">9:</td><td style="text-align: right;">10.2</td><td style="text-align: right;">←</td></tr> <tr><td style="text-align: right;">10:</td><td style="text-align: right;">9.3</td><td style="text-align: right;">→</td></tr> </table> <table border="1" style="width:100%; border-collapse: collapse; margin-top: 5px;"> <tr> <td style="width:80%;">Serie</td> <td style="text-align: right;">98.0</td> </tr> <tr> <td>Total</td> <td style="text-align: right;">98.0</td> </tr> </table> | 1: | *10.8 | ↖ | 2: | 10.1 | ↗ | 3: | 10.0 | ↑ | 4: | 10.4 | ← | 5: | 10.2 | ↙ | 6: | *10.5 | ↘ | 7: | 10.4 | ↑ | 8: | 9.9 | ↗ | 9: | 10.2 | ← | 10: | 9.3 | → | Serie | 98.0 | Total | 98.0 |
| 1: | *10.8 | ↖ | | | | | | | | | | | | | | | | | | | | | | | | | | | | | | | | | |
| 2: | 10.1 | ↗ | | | | | | | | | | | | | | | | | | | | | | | | | | | | | | | | | |
| 3: | 10.0 | ↑ | | | | | | | | | | | | | | | | | | | | | | | | | | | | | | | | | |
| 4: | 10.4 | ← | | | | | | | | | | | | | | | | | | | | | | | | | | | | | | | | | |
| 5: | 10.2 | ↙ | | | | | | | | | | | | | | | | | | | | | | | | | | | | | | | | | |
| 6: | *10.5 | ↘ | | | | | | | | | | | | | | | | | | | | | | | | | | | | | | | | | |
| 7: | 10.4 | ↑ | | | | | | | | | | | | | | | | | | | | | | | | | | | | | | | | | |
| 8: | 9.9 | ↗ | | | | | | | | | | | | | | | | | | | | | | | | | | | | | | | | | |
| 9: | 10.2 | ← | | | | | | | | | | | | | | | | | | | | | | | | | | | | | | | | | |
| 10: | 9.3 | → | | | | | | | | | | | | | | | | | | | | | | | | | | | | | | | | | |
| Serie | 98.0 | | | | | | | | | | | | | | | | | | | | | | | | | | | | | | | | | | |
| Total | 98.0 | | | | | | | | | | | | | | | | | | | | | | | | | | | | | | | | | | |

| | | | | | | | | | | | | | | | | | | | | | | | | | | | | | | | | | | | |
|-----------------------|--|-----|-----|---|-----|-----|---|-----|------|---|-----|------|---|-----|------|---|-----|-----|---|-----|------|---|-----|-----|---|-----|------|---|-----|-----|---|-------|------|-------|-------|
| <p>20 Skud</p> | <table style="width:100%; border-collapse: collapse;"> <tr><td style="text-align: right;">11:</td><td style="text-align: right;">9.6</td><td style="text-align: right;">↘</td></tr> <tr><td style="text-align: right;">12:</td><td style="text-align: right;">9.8</td><td style="text-align: right;">→</td></tr> <tr><td style="text-align: right;">13:</td><td style="text-align: right;">10.4</td><td style="text-align: right;">↘</td></tr> <tr><td style="text-align: right;">14:</td><td style="text-align: right;">10.4</td><td style="text-align: right;">↑</td></tr> <tr><td style="text-align: right;">15:</td><td style="text-align: right;">10.3</td><td style="text-align: right;">↑</td></tr> <tr><td style="text-align: right;">16:</td><td style="text-align: right;">9.2</td><td style="text-align: right;">→</td></tr> <tr><td style="text-align: right;">17:</td><td style="text-align: right;">10.3</td><td style="text-align: right;">↘</td></tr> <tr><td style="text-align: right;">18:</td><td style="text-align: right;">9.9</td><td style="text-align: right;">↗</td></tr> <tr><td style="text-align: right;">19:</td><td style="text-align: right;">10.4</td><td style="text-align: right;">↑</td></tr> <tr><td style="text-align: right;">20:</td><td style="text-align: right;">9.7</td><td style="text-align: right;">↙</td></tr> </table> <table border="1" style="width:100%; border-collapse: collapse; margin-top: 5px;"> <tr> <td style="width:80%;">Serie</td> <td style="text-align: right;">95.0</td> </tr> <tr> <td>Total</td> <td style="text-align: right;">193.0</td> </tr> </table> | 11: | 9.6 | ↘ | 12: | 9.8 | → | 13: | 10.4 | ↘ | 14: | 10.4 | ↑ | 15: | 10.3 | ↑ | 16: | 9.2 | → | 17: | 10.3 | ↘ | 18: | 9.9 | ↗ | 19: | 10.4 | ↑ | 20: | 9.7 | ↙ | Serie | 95.0 | Total | 193.0 |
| 11: | 9.6 | ↘ | | | | | | | | | | | | | | | | | | | | | | | | | | | | | | | | | |
| 12: | 9.8 | → | | | | | | | | | | | | | | | | | | | | | | | | | | | | | | | | | |
| 13: | 10.4 | ↘ | | | | | | | | | | | | | | | | | | | | | | | | | | | | | | | | | |
| 14: | 10.4 | ↑ | | | | | | | | | | | | | | | | | | | | | | | | | | | | | | | | | |
| 15: | 10.3 | ↑ | | | | | | | | | | | | | | | | | | | | | | | | | | | | | | | | | |
| 16: | 9.2 | → | | | | | | | | | | | | | | | | | | | | | | | | | | | | | | | | | |
| 17: | 10.3 | ↘ | | | | | | | | | | | | | | | | | | | | | | | | | | | | | | | | | |
| 18: | 9.9 | ↗ | | | | | | | | | | | | | | | | | | | | | | | | | | | | | | | | | |
| 19: | 10.4 | ↑ | | | | | | | | | | | | | | | | | | | | | | | | | | | | | | | | | |
| 20: | 9.7 | ↙ | | | | | | | | | | | | | | | | | | | | | | | | | | | | | | | | | |
| Serie | 95.0 | | | | | | | | | | | | | | | | | | | | | | | | | | | | | | | | | | |
| Total | 193.0 | | | | | | | | | | | | | | | | | | | | | | | | | | | | | | | | | | |

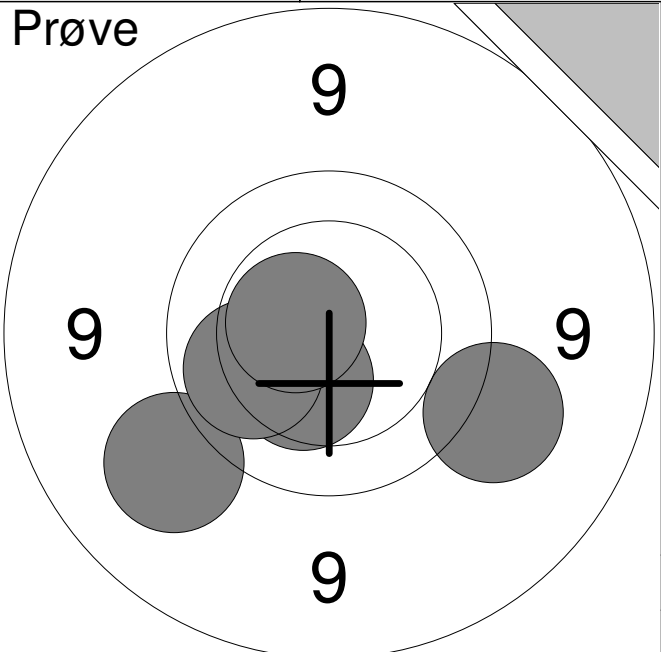
| | | | | | | | | | | | | | | | | | | | | |
|--|--|----|------|---|----|-----|---|----|-----|---|----|------|---|----|-------|---|-------|------|-------|-----|
| <p>Prøve</p>  | <table style="width:100%; border-collapse: collapse;"> <tr><td style="width:10%;">1:</td><td style="width:15%;">10.4</td><td style="width:10%; text-align: right;">↙</td></tr> <tr><td>2:</td><td>9.3</td><td style="text-align: right;">↙</td></tr> <tr><td>3:</td><td>9.4</td><td style="text-align: right;">↘</td></tr> <tr><td>4:</td><td>10.0</td><td style="text-align: right;">↙</td></tr> <tr><td>5:</td><td>*10.6</td><td style="text-align: right;">↙</td></tr> </table> <table border="1" style="width:100%; border-collapse: collapse; margin-top: 5px;"> <tr> <td style="width:80%;">Serie</td> <td style="text-align: right;">48.0</td> </tr> <tr> <td>Total</td> <td style="text-align: right;">0.0</td> </tr> </table> | 1: | 10.4 | ↙ | 2: | 9.3 | ↙ | 3: | 9.4 | ↘ | 4: | 10.0 | ↙ | 5: | *10.6 | ↙ | Serie | 48.0 | Total | 0.0 |
| 1: | 10.4 | ↙ | | | | | | | | | | | | | | | | | | |
| 2: | 9.3 | ↙ | | | | | | | | | | | | | | | | | | |
| 3: | 9.4 | ↘ | | | | | | | | | | | | | | | | | | |
| 4: | 10.0 | ↙ | | | | | | | | | | | | | | | | | | |
| 5: | *10.6 | ↙ | | | | | | | | | | | | | | | | | | |
| Serie | 48.0 | | | | | | | | | | | | | | | | | | | |
| Total | 0.0 | | | | | | | | | | | | | | | | | | | |

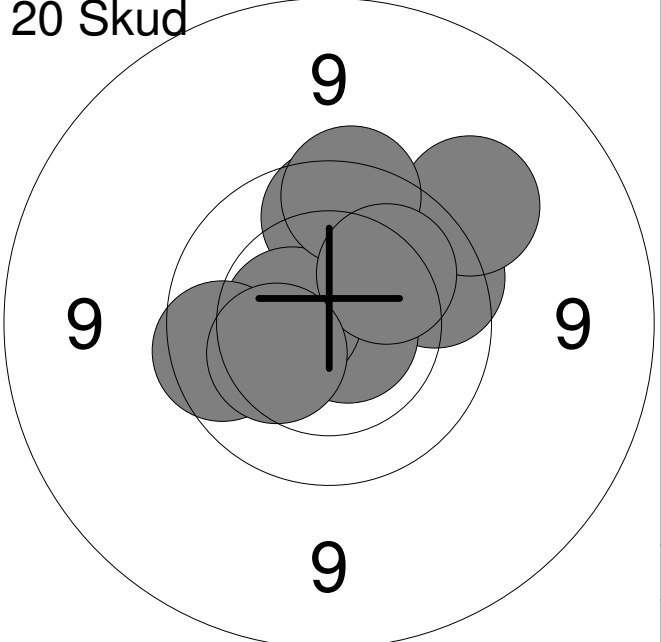
| | | | | | | | | | | | | | | | | | | | | | | | | | | | | | | | | | | | |
|---|---|----|-----|---|----|------|---|----|-------|---|----|-----|---|----|-----|---|----|-------|---|----|-----|---|----|-----|---|----|------|---|-----|------|---|-------|------|-------|------|
| <p>20 Skud</p>  | <table style="width:100%; border-collapse: collapse;"> <tr><td style="width:10%;">1:</td><td style="width:15%;">9.8</td><td style="width:10%; text-align: right;">→</td></tr> <tr><td>2:</td><td>10.4</td><td style="text-align: right;">↗</td></tr> <tr><td>3:</td><td>*10.7</td><td style="text-align: right;">↘</td></tr> <tr><td>4:</td><td>9.9</td><td style="text-align: right;">↑</td></tr> <tr><td>5:</td><td>9.4</td><td style="text-align: right;">↗</td></tr> <tr><td>6:</td><td>*10.5</td><td style="text-align: right;">↙</td></tr> <tr><td>7:</td><td>9.7</td><td style="text-align: right;">↑</td></tr> <tr><td>8:</td><td>9.8</td><td style="text-align: right;">↙</td></tr> <tr><td>9:</td><td>10.1</td><td style="text-align: right;">↗</td></tr> <tr><td>10:</td><td>10.3</td><td style="text-align: right;">↙</td></tr> </table> <table border="1" style="width:100%; border-collapse: collapse; margin-top: 5px;"> <tr> <td style="width:80%;">Serie</td> <td style="text-align: right;">95.0</td> </tr> <tr> <td>Total</td> <td style="text-align: right;">95.0</td> </tr> </table> | 1: | 9.8 | → | 2: | 10.4 | ↗ | 3: | *10.7 | ↘ | 4: | 9.9 | ↑ | 5: | 9.4 | ↗ | 6: | *10.5 | ↙ | 7: | 9.7 | ↑ | 8: | 9.8 | ↙ | 9: | 10.1 | ↗ | 10: | 10.3 | ↙ | Serie | 95.0 | Total | 95.0 |
| 1: | 9.8 | → | | | | | | | | | | | | | | | | | | | | | | | | | | | | | | | | | |
| 2: | 10.4 | ↗ | | | | | | | | | | | | | | | | | | | | | | | | | | | | | | | | | |
| 3: | *10.7 | ↘ | | | | | | | | | | | | | | | | | | | | | | | | | | | | | | | | | |
| 4: | 9.9 | ↑ | | | | | | | | | | | | | | | | | | | | | | | | | | | | | | | | | |
| 5: | 9.4 | ↗ | | | | | | | | | | | | | | | | | | | | | | | | | | | | | | | | | |
| 6: | *10.5 | ↙ | | | | | | | | | | | | | | | | | | | | | | | | | | | | | | | | | |
| 7: | 9.7 | ↑ | | | | | | | | | | | | | | | | | | | | | | | | | | | | | | | | | |
| 8: | 9.8 | ↙ | | | | | | | | | | | | | | | | | | | | | | | | | | | | | | | | | |
| 9: | 10.1 | ↗ | | | | | | | | | | | | | | | | | | | | | | | | | | | | | | | | | |
| 10: | 10.3 | ↙ | | | | | | | | | | | | | | | | | | | | | | | | | | | | | | | | | |
| Serie | 95.0 | | | | | | | | | | | | | | | | | | | | | | | | | | | | | | | | | | |
| Total | 95.0 | | | | | | | | | | | | | | | | | | | | | | | | | | | | | | | | | | |

| | | | | | | | | | | | | | | | | | | | | | | | | | | | | | | | | | | | |
|--|--|-----|-------|---|-----|-------|---|-----|------|---|-----|-------|---|-----|-----|---|-----|-----|---|-----|-------|---|-----|------|---|-----|------|---|-----|------|---|-------|------|-------|-------|
| <p>20 Skud</p>  | <table style="width:100%; border-collapse: collapse;"> <tr><td style="width:10%;">11:</td><td style="width:15%;">*10.5</td><td style="width:10%; text-align: right;">↗</td></tr> <tr><td>12:</td><td>*10.5</td><td style="text-align: right;">↙</td></tr> <tr><td>13:</td><td>10.2</td><td style="text-align: right;">↙</td></tr> <tr><td>14:</td><td>*10.6</td><td style="text-align: right;">↘</td></tr> <tr><td>15:</td><td>9.4</td><td style="text-align: right;">↗</td></tr> <tr><td>16:</td><td>9.9</td><td style="text-align: right;">↙</td></tr> <tr><td>17:</td><td>*10.5</td><td style="text-align: right;">↙</td></tr> <tr><td>18:</td><td>10.2</td><td style="text-align: right;">↙</td></tr> <tr><td>19:</td><td>10.1</td><td style="text-align: right;">↗</td></tr> <tr><td>20:</td><td>10.0</td><td style="text-align: right;">→</td></tr> </table> <table border="1" style="width:100%; border-collapse: collapse; margin-top: 5px;"> <tr> <td style="width:80%;">Serie</td> <td style="text-align: right;">98.0</td> </tr> <tr> <td>Total</td> <td style="text-align: right;">193.0</td> </tr> </table> | 11: | *10.5 | ↗ | 12: | *10.5 | ↙ | 13: | 10.2 | ↙ | 14: | *10.6 | ↘ | 15: | 9.4 | ↗ | 16: | 9.9 | ↙ | 17: | *10.5 | ↙ | 18: | 10.2 | ↙ | 19: | 10.1 | ↗ | 20: | 10.0 | → | Serie | 98.0 | Total | 193.0 |
| 11: | *10.5 | ↗ | | | | | | | | | | | | | | | | | | | | | | | | | | | | | | | | | |
| 12: | *10.5 | ↙ | | | | | | | | | | | | | | | | | | | | | | | | | | | | | | | | | |
| 13: | 10.2 | ↙ | | | | | | | | | | | | | | | | | | | | | | | | | | | | | | | | | |
| 14: | *10.6 | ↘ | | | | | | | | | | | | | | | | | | | | | | | | | | | | | | | | | |
| 15: | 9.4 | ↗ | | | | | | | | | | | | | | | | | | | | | | | | | | | | | | | | | |
| 16: | 9.9 | ↙ | | | | | | | | | | | | | | | | | | | | | | | | | | | | | | | | | |
| 17: | *10.5 | ↙ | | | | | | | | | | | | | | | | | | | | | | | | | | | | | | | | | |
| 18: | 10.2 | ↙ | | | | | | | | | | | | | | | | | | | | | | | | | | | | | | | | | |
| 19: | 10.1 | ↗ | | | | | | | | | | | | | | | | | | | | | | | | | | | | | | | | | |
| 20: | 10.0 | → | | | | | | | | | | | | | | | | | | | | | | | | | | | | | | | | | |
| Serie | 98.0 | | | | | | | | | | | | | | | | | | | | | | | | | | | | | | | | | | |
| Total | 193.0 | | | | | | | | | | | | | | | | | | | | | | | | | | | | | | | | | | |

| | | | | | | | | | | | | | | | | | | | | | | |
|---------------------|--|------|-------|---|----|------|---|----|------|---|----|------|---|----|------|---|-------|--|------|-------|--|-----|
| <p>Prøve</p> | <table style="width:100%; border-collapse: collapse;"> <tr><td style="width:10%;">1:</td><td style="width:10%;">*10.6</td><td style="width:10%; text-align: right;">↗</td></tr> <tr><td>2:</td><td>10.3</td><td style="text-align: right;">↘</td></tr> <tr><td>3:</td><td>10.2</td><td style="text-align: right;">↙</td></tr> <tr><td>4:</td><td>10.4</td><td style="text-align: right;">↗</td></tr> <tr><td>5:</td><td>10.6</td><td style="text-align: right;">↗</td></tr> </table> <hr/> <table style="width:100%; border-collapse: collapse;"> <tr> <td style="width:10%;">Serie</td> <td style="width:10%;"></td> <td style="width:10%; text-align: right;">50.0</td> </tr> <tr> <td>Total</td> <td></td> <td style="text-align: right;">0.0</td> </tr> </table> | 1: | *10.6 | ↗ | 2: | 10.3 | ↘ | 3: | 10.2 | ↙ | 4: | 10.4 | ↗ | 5: | 10.6 | ↗ | Serie | | 50.0 | Total | | 0.0 |
| 1: | *10.6 | ↗ | | | | | | | | | | | | | | | | | | | | |
| 2: | 10.3 | ↘ | | | | | | | | | | | | | | | | | | | | |
| 3: | 10.2 | ↙ | | | | | | | | | | | | | | | | | | | | |
| 4: | 10.4 | ↗ | | | | | | | | | | | | | | | | | | | | |
| 5: | 10.6 | ↗ | | | | | | | | | | | | | | | | | | | | |
| Serie | | 50.0 | | | | | | | | | | | | | | | | | | | | |
| Total | | 0.0 | | | | | | | | | | | | | | | | | | | | |

| | | | | | | | | | | | | | | | | | | | | | | | | | | | | | | | | | | | | | |
|-----------------------|---|------|-------|---|----|-------|---|----|-----|---|----|------|---|----|------|---|----|------|---|----|-----|---|----|------|---|----|-------|---|-----|------|---|-------|--|------|-------|--|------|
| <p>20 Skud</p> | <table style="width:100%; border-collapse: collapse;"> <tr><td style="width:10%;">1:</td><td style="width:10%;">*10.8</td><td style="width:10%; text-align: right;">↘</td></tr> <tr><td>2:</td><td>*10.6</td><td style="text-align: right;">↘</td></tr> <tr><td>3:</td><td>9.8</td><td style="text-align: right;">↗</td></tr> <tr><td>4:</td><td>10.5</td><td style="text-align: right;">↖</td></tr> <tr><td>5:</td><td>10.4</td><td style="text-align: right;">↖</td></tr> <tr><td>6:</td><td>10.4</td><td style="text-align: right;">↖</td></tr> <tr><td>7:</td><td>9.8</td><td style="text-align: right;">↗</td></tr> <tr><td>8:</td><td>10.6</td><td style="text-align: right;">↘</td></tr> <tr><td>9:</td><td>*10.7</td><td style="text-align: right;">↘</td></tr> <tr><td>10:</td><td>10.3</td><td style="text-align: right;">↗</td></tr> </table> <hr/> <table style="width:100%; border-collapse: collapse;"> <tr> <td style="width:10%;">Serie</td> <td style="width:10%;"></td> <td style="width:10%; text-align: right;">98.0</td> </tr> <tr> <td>Total</td> <td></td> <td style="text-align: right;">98.0</td> </tr> </table> | 1: | *10.8 | ↘ | 2: | *10.6 | ↘ | 3: | 9.8 | ↗ | 4: | 10.5 | ↖ | 5: | 10.4 | ↖ | 6: | 10.4 | ↖ | 7: | 9.8 | ↗ | 8: | 10.6 | ↘ | 9: | *10.7 | ↘ | 10: | 10.3 | ↗ | Serie | | 98.0 | Total | | 98.0 |
| 1: | *10.8 | ↘ | | | | | | | | | | | | | | | | | | | | | | | | | | | | | | | | | | | |
| 2: | *10.6 | ↘ | | | | | | | | | | | | | | | | | | | | | | | | | | | | | | | | | | | |
| 3: | 9.8 | ↗ | | | | | | | | | | | | | | | | | | | | | | | | | | | | | | | | | | | |
| 4: | 10.5 | ↖ | | | | | | | | | | | | | | | | | | | | | | | | | | | | | | | | | | | |
| 5: | 10.4 | ↖ | | | | | | | | | | | | | | | | | | | | | | | | | | | | | | | | | | | |
| 6: | 10.4 | ↖ | | | | | | | | | | | | | | | | | | | | | | | | | | | | | | | | | | | |
| 7: | 9.8 | ↗ | | | | | | | | | | | | | | | | | | | | | | | | | | | | | | | | | | | |
| 8: | 10.6 | ↘ | | | | | | | | | | | | | | | | | | | | | | | | | | | | | | | | | | | |
| 9: | *10.7 | ↘ | | | | | | | | | | | | | | | | | | | | | | | | | | | | | | | | | | | |
| 10: | 10.3 | ↗ | | | | | | | | | | | | | | | | | | | | | | | | | | | | | | | | | | | |
| Serie | | 98.0 | | | | | | | | | | | | | | | | | | | | | | | | | | | | | | | | | | | |
| Total | | 98.0 | | | | | | | | | | | | | | | | | | | | | | | | | | | | | | | | | | | |

| | | | | | | | | | | | | | | | | | | | | | | | | | | | | | | | | | | | | | |
|-----------------------|--|-------|------|---|-----|-----|---|-----|-------|---|-----|-------|---|-----|------|---|-----|------|---|-----|-----|---|-----|-------|---|-----|------|---|-----|-------|---|-------|--|------|-------|--|-------|
| <p>20 Skud</p> | <table style="width:100%; border-collapse: collapse;"> <tr><td style="width:10%;">11:</td><td style="width:10%;">10.5</td><td style="width:10%; text-align: right;">↗</td></tr> <tr><td>12:</td><td>9.6</td><td style="text-align: right;">↗</td></tr> <tr><td>13:</td><td>*10.8</td><td style="text-align: right;">↘</td></tr> <tr><td>14:</td><td>*10.6</td><td style="text-align: right;">↘</td></tr> <tr><td>15:</td><td>10.0</td><td style="text-align: right;">↘</td></tr> <tr><td>16:</td><td>10.6</td><td style="text-align: right;">↗</td></tr> <tr><td>17:</td><td>9.7</td><td style="text-align: right;">↘</td></tr> <tr><td>18:</td><td>*10.9</td><td style="text-align: right;">↗</td></tr> <tr><td>19:</td><td>10.0</td><td style="text-align: right;">→</td></tr> <tr><td>20:</td><td>*10.8</td><td style="text-align: right;">↗</td></tr> </table> <hr/> <table style="width:100%; border-collapse: collapse;"> <tr> <td style="width:10%;">Serie</td> <td style="width:10%;"></td> <td style="width:10%; text-align: right;">98.0</td> </tr> <tr> <td>Total</td> <td></td> <td style="text-align: right;">196.0</td> </tr> </table> | 11: | 10.5 | ↗ | 12: | 9.6 | ↗ | 13: | *10.8 | ↘ | 14: | *10.6 | ↘ | 15: | 10.0 | ↘ | 16: | 10.6 | ↗ | 17: | 9.7 | ↘ | 18: | *10.9 | ↗ | 19: | 10.0 | → | 20: | *10.8 | ↗ | Serie | | 98.0 | Total | | 196.0 |
| 11: | 10.5 | ↗ | | | | | | | | | | | | | | | | | | | | | | | | | | | | | | | | | | | |
| 12: | 9.6 | ↗ | | | | | | | | | | | | | | | | | | | | | | | | | | | | | | | | | | | |
| 13: | *10.8 | ↘ | | | | | | | | | | | | | | | | | | | | | | | | | | | | | | | | | | | |
| 14: | *10.6 | ↘ | | | | | | | | | | | | | | | | | | | | | | | | | | | | | | | | | | | |
| 15: | 10.0 | ↘ | | | | | | | | | | | | | | | | | | | | | | | | | | | | | | | | | | | |
| 16: | 10.6 | ↗ | | | | | | | | | | | | | | | | | | | | | | | | | | | | | | | | | | | |
| 17: | 9.7 | ↘ | | | | | | | | | | | | | | | | | | | | | | | | | | | | | | | | | | | |
| 18: | *10.9 | ↗ | | | | | | | | | | | | | | | | | | | | | | | | | | | | | | | | | | | |
| 19: | 10.0 | → | | | | | | | | | | | | | | | | | | | | | | | | | | | | | | | | | | | |
| 20: | *10.8 | ↗ | | | | | | | | | | | | | | | | | | | | | | | | | | | | | | | | | | | |
| Serie | | 98.0 | | | | | | | | | | | | | | | | | | | | | | | | | | | | | | | | | | | |
| Total | | 196.0 | | | | | | | | | | | | | | | | | | | | | | | | | | | | | | | | | | | |

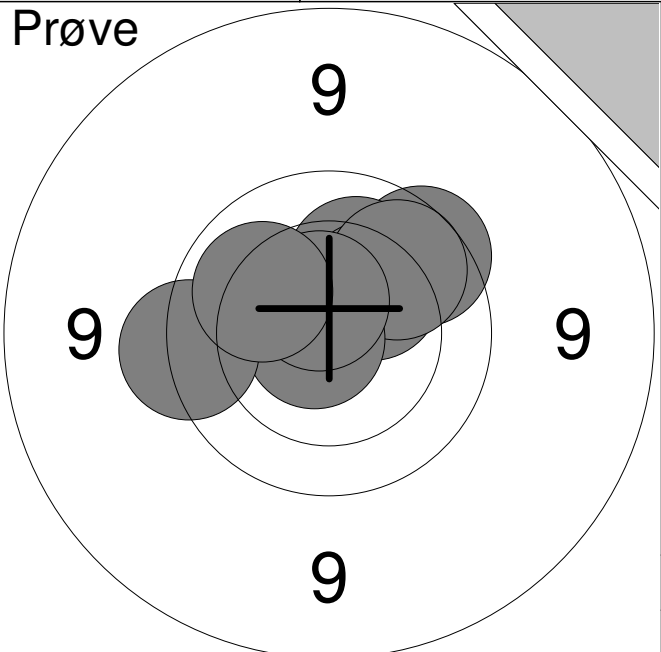
| | | | | | | | | | | | | | | | | | | | | | | | | | |
|--|--|----|-----|---|----|------|---|----|------|---|----|-----|---|----|-------|---|----|-----|---|----|-------|---|----|------|---|
| <p>Prøve</p>  | <table style="width:100%; border-collapse: collapse;"> <tr><td>1:</td><td>9.8</td><td>↗</td></tr> <tr><td>2:</td><td>10.2</td><td>↑</td></tr> <tr><td>3:</td><td>10.3</td><td>↗</td></tr> <tr><td>4:</td><td>9.9</td><td>↗</td></tr> <tr><td>5:</td><td>*10.8</td><td>←</td></tr> <tr><td>6:</td><td>9.7</td><td>←</td></tr> <tr><td>7:</td><td>*10.6</td><td>↑</td></tr> <tr><td>8:</td><td>10.1</td><td>↗</td></tr> </table> | 1: | 9.8 | ↗ | 2: | 10.2 | ↑ | 3: | 10.3 | ↗ | 4: | 9.9 | ↗ | 5: | *10.8 | ← | 6: | 9.7 | ← | 7: | *10.6 | ↑ | 8: | 10.1 | ↗ |
| 1: | 9.8 | ↗ | | | | | | | | | | | | | | | | | | | | | | | |
| 2: | 10.2 | ↑ | | | | | | | | | | | | | | | | | | | | | | | |
| 3: | 10.3 | ↗ | | | | | | | | | | | | | | | | | | | | | | | |
| 4: | 9.9 | ↗ | | | | | | | | | | | | | | | | | | | | | | | |
| 5: | *10.8 | ← | | | | | | | | | | | | | | | | | | | | | | | |
| 6: | 9.7 | ← | | | | | | | | | | | | | | | | | | | | | | | |
| 7: | *10.6 | ↑ | | | | | | | | | | | | | | | | | | | | | | | |
| 8: | 10.1 | ↗ | | | | | | | | | | | | | | | | | | | | | | | |
| | Serie 77.0 | | | | | | | | | | | | | | | | | | | | | | | | |
| | Total 0.0 | | | | | | | | | | | | | | | | | | | | | | | | |

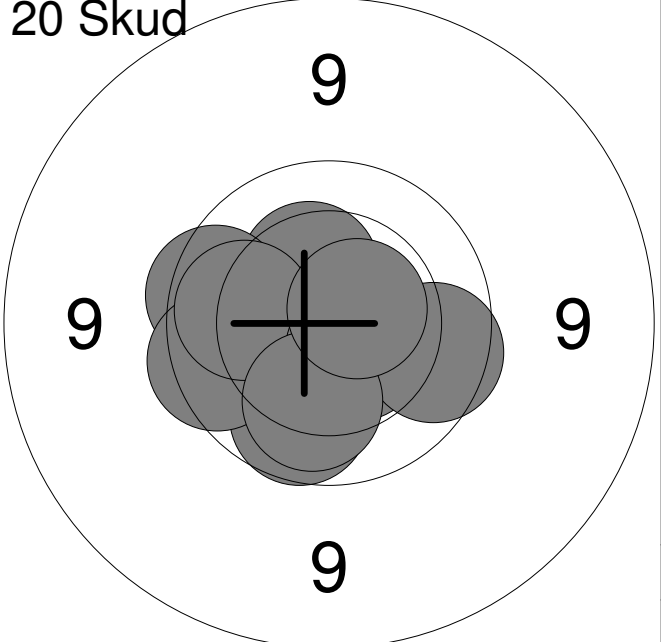
| | | | | | | | | | | | | | | | | | | | | | | | | | | | | | | | |
|---|--|----|------|---|----|-----|---|----|------|---|----|-----|---|----|-----|---|----|------|---|----|-------|---|----|-----|---|----|------|---|-----|-------|---|
| <p>20 Skud</p>  | <table style="width:100%; border-collapse: collapse;"> <tr><td>1:</td><td>10.4</td><td>↗</td></tr> <tr><td>2:</td><td>9.8</td><td>←</td></tr> <tr><td>3:</td><td>10.1</td><td>←</td></tr> <tr><td>4:</td><td>9.9</td><td>↓</td></tr> <tr><td>5:</td><td>9.8</td><td>←</td></tr> <tr><td>6:</td><td>10.0</td><td>←</td></tr> <tr><td>7:</td><td>*10.5</td><td>↓</td></tr> <tr><td>8:</td><td>9.9</td><td>→</td></tr> <tr><td>9:</td><td>10.1</td><td>↓</td></tr> <tr><td>10:</td><td>*10.6</td><td>↗</td></tr> </table> | 1: | 10.4 | ↗ | 2: | 9.8 | ← | 3: | 10.1 | ← | 4: | 9.9 | ↓ | 5: | 9.8 | ← | 6: | 10.0 | ← | 7: | *10.5 | ↓ | 8: | 9.9 | → | 9: | 10.1 | ↓ | 10: | *10.6 | ↗ |
| 1: | 10.4 | ↗ | | | | | | | | | | | | | | | | | | | | | | | | | | | | | |
| 2: | 9.8 | ← | | | | | | | | | | | | | | | | | | | | | | | | | | | | | |
| 3: | 10.1 | ← | | | | | | | | | | | | | | | | | | | | | | | | | | | | | |
| 4: | 9.9 | ↓ | | | | | | | | | | | | | | | | | | | | | | | | | | | | | |
| 5: | 9.8 | ← | | | | | | | | | | | | | | | | | | | | | | | | | | | | | |
| 6: | 10.0 | ← | | | | | | | | | | | | | | | | | | | | | | | | | | | | | |
| 7: | *10.5 | ↓ | | | | | | | | | | | | | | | | | | | | | | | | | | | | | |
| 8: | 9.9 | → | | | | | | | | | | | | | | | | | | | | | | | | | | | | | |
| 9: | 10.1 | ↓ | | | | | | | | | | | | | | | | | | | | | | | | | | | | | |
| 10: | *10.6 | ↗ | | | | | | | | | | | | | | | | | | | | | | | | | | | | | |
| | Serie 96.0 | | | | | | | | | | | | | | | | | | | | | | | | | | | | | | |
| | Total 96.0 | | | | | | | | | | | | | | | | | | | | | | | | | | | | | | |

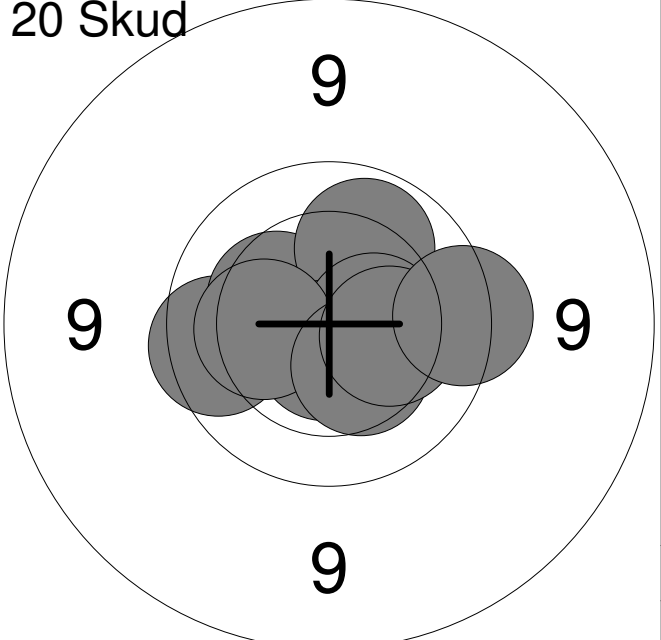
| | | | | | | | | | | | | | | | | | | | | | | | | | | | | | | | |
|--|--|-----|------|---|-----|-----|---|-----|------|---|-----|------|---|-----|-------|---|-----|------|---|-----|------|---|-----|------|---|-----|------|---|-----|-----|---|
| <p>20 Skud</p>  | <table style="width:100%; border-collapse: collapse;"> <tr><td>11:</td><td>10.3</td><td>→</td></tr> <tr><td>12:</td><td>9.8</td><td>←</td></tr> <tr><td>13:</td><td>10.3</td><td>↗</td></tr> <tr><td>14:</td><td>10.0</td><td>↗</td></tr> <tr><td>15:</td><td>*10.7</td><td>↓</td></tr> <tr><td>16:</td><td>10.5</td><td>→</td></tr> <tr><td>17:</td><td>10.2</td><td>←</td></tr> <tr><td>18:</td><td>10.4</td><td>↓</td></tr> <tr><td>19:</td><td>10.3</td><td>→</td></tr> <tr><td>20:</td><td>9.7</td><td>→</td></tr> </table> | 11: | 10.3 | → | 12: | 9.8 | ← | 13: | 10.3 | ↗ | 14: | 10.0 | ↗ | 15: | *10.7 | ↓ | 16: | 10.5 | → | 17: | 10.2 | ← | 18: | 10.4 | ↓ | 19: | 10.3 | → | 20: | 9.7 | → |
| 11: | 10.3 | → | | | | | | | | | | | | | | | | | | | | | | | | | | | | | |
| 12: | 9.8 | ← | | | | | | | | | | | | | | | | | | | | | | | | | | | | | |
| 13: | 10.3 | ↗ | | | | | | | | | | | | | | | | | | | | | | | | | | | | | |
| 14: | 10.0 | ↗ | | | | | | | | | | | | | | | | | | | | | | | | | | | | | |
| 15: | *10.7 | ↓ | | | | | | | | | | | | | | | | | | | | | | | | | | | | | |
| 16: | 10.5 | → | | | | | | | | | | | | | | | | | | | | | | | | | | | | | |
| 17: | 10.2 | ← | | | | | | | | | | | | | | | | | | | | | | | | | | | | | |
| 18: | 10.4 | ↓ | | | | | | | | | | | | | | | | | | | | | | | | | | | | | |
| 19: | 10.3 | → | | | | | | | | | | | | | | | | | | | | | | | | | | | | | |
| 20: | 9.7 | → | | | | | | | | | | | | | | | | | | | | | | | | | | | | | |
| | Serie 98.0 | | | | | | | | | | | | | | | | | | | | | | | | | | | | | | |
| | Total 194.0 | | | | | | | | | | | | | | | | | | | | | | | | | | | | | | |

Hold
29

Skive
3

Elisabeth Bisgaard Larsen

Vilsted Skf.

MB1

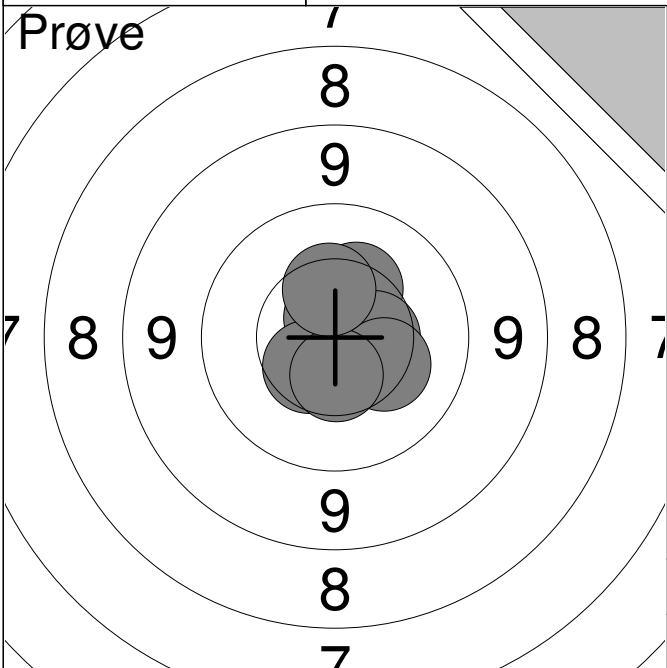

| | | |
|----|-------|---|
| 1: | 10.3 | ↗ |
| 2: | *10.7 | ↑ |
| 3: | 10.5 | → |
| 4: | 10.5 | ↖ |
| 5: | 10.3 | ↘ |
| 6: | 10.5 | ↓ |
| 7: | 10.4 | ↑ |

| | |
|-------|------|
| Serie | 70.0 |
| Total | 0.0 |

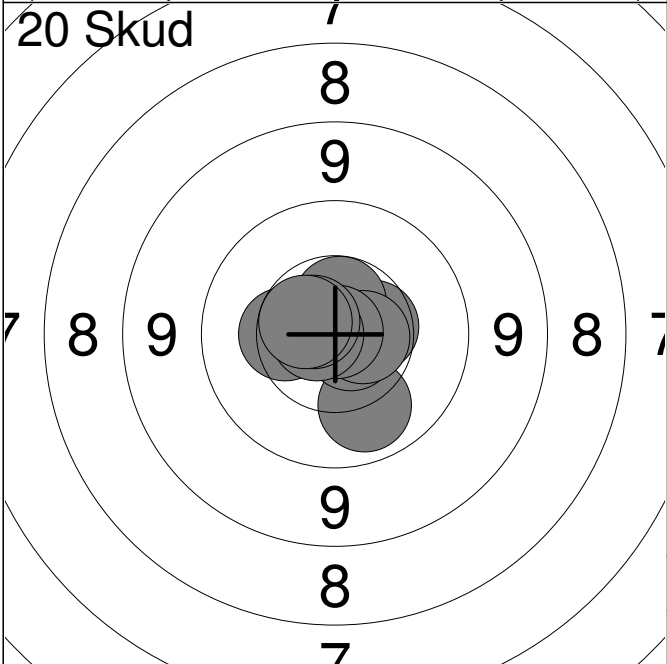

| | | |
|-----|-------|---|
| 1: | 10.1 | ↘ |
| 2: | *10.7 | ↘ |
| 3: | 10.5 | → |
| 4: | *10.6 | ↑ |
| 5: | *10.6 | → |
| 6: | 10.4 | ← |
| 7: | *10.9 | ↗ |
| 8: | *10.7 | ← |
| 9: | *10.7 | ↗ |
| 10: | 10.6 | ← |

| | |
|-------|-------|
| Serie | 100.0 |
| Total | 100.0 |

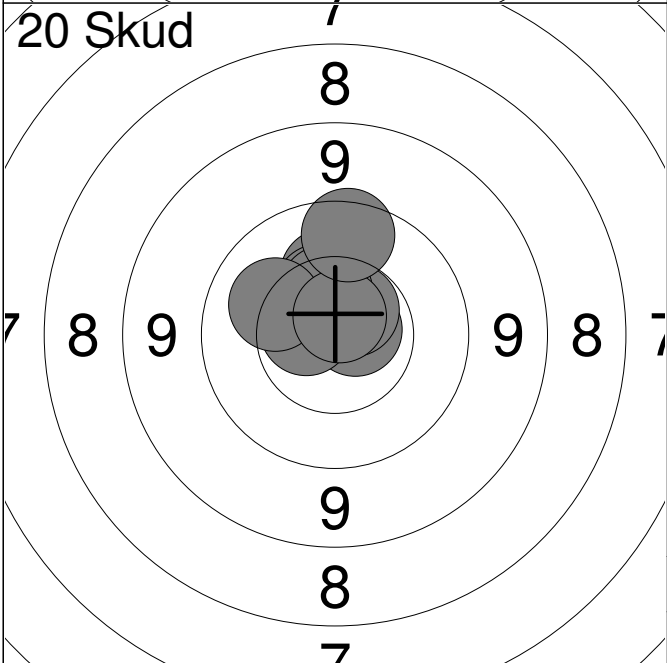

| | | |
|-----|-------|---|
| 11: | *10.7 | → |
| 12: | 10.3 | ↑ |
| 13: | *10.6 | ↗ |
| 14: | 10.4 | ↑ |
| 15: | *10.6 | ↗ |
| 16: | 10.4 | ↑ |
| 17: | *10.6 | ← |
| 18: | 10.2 | ↖ |
| 19: | *10.7 | ↑ |
| 20: | 9.8 | ↑ |

| | |
|-------|-------|
| Serie | 99.0 |
| Total | 199.0 |

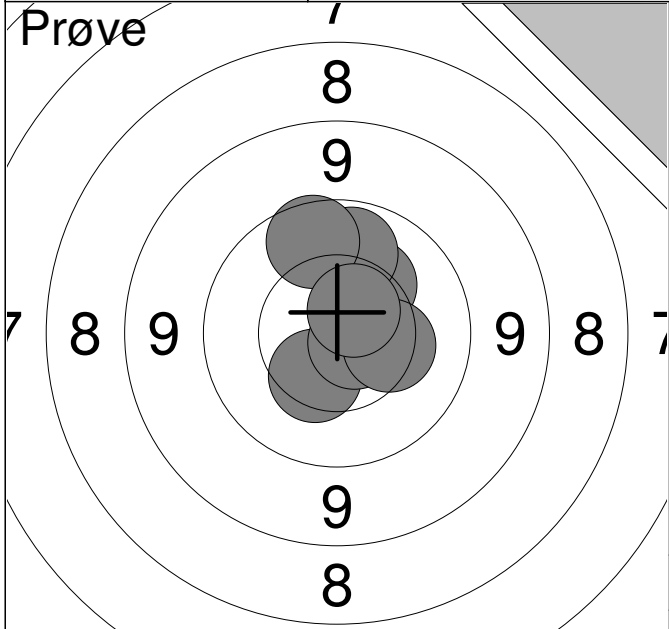
| | | | | | | | | | | | | | | | | | | | | | | |
|--|--|-------|------|-------|-----|------|---|----|------|---|----|-------|---|----|------|---|----|-----|---|----|-------|---|
| Prøve  | <table style="width:100%; border-collapse: collapse;"> <tr><td style="width:10%;">1:</td><td style="width:15%;">10.4</td><td style="width:10%; text-align: right;">↙</td></tr> <tr><td>2:</td><td>10.3</td><td style="text-align: right;">↗</td></tr> <tr><td>3:</td><td>10.0</td><td style="text-align: right;">↑</td></tr> <tr><td>4:</td><td>*10.7</td><td style="text-align: right;">↘</td></tr> <tr><td>5:</td><td>10.3</td><td style="text-align: right;">→</td></tr> <tr><td>6:</td><td>9.8</td><td style="text-align: right;">↑</td></tr> <tr><td>7:</td><td>*10.6</td><td style="text-align: right;">↗</td></tr> </table> | 1: | 10.4 | ↙ | 2: | 10.3 | ↗ | 3: | 10.0 | ↑ | 4: | *10.7 | ↘ | 5: | 10.3 | → | 6: | 9.8 | ↑ | 7: | *10.6 | ↗ |
| 1: | 10.4 | ↙ | | | | | | | | | | | | | | | | | | | | |
| 2: | 10.3 | ↗ | | | | | | | | | | | | | | | | | | | | |
| 3: | 10.0 | ↑ | | | | | | | | | | | | | | | | | | | | |
| 4: | *10.7 | ↘ | | | | | | | | | | | | | | | | | | | | |
| 5: | 10.3 | → | | | | | | | | | | | | | | | | | | | | |
| 6: | 9.8 | ↑ | | | | | | | | | | | | | | | | | | | | |
| 7: | *10.6 | ↗ | | | | | | | | | | | | | | | | | | | | |
| <table style="width:100%; border-collapse: collapse;"> <tr> <td style="width:45%;">Serie</td> <td style="width:55%; text-align: right;">69.0</td> </tr> <tr> <td>Total</td> <td style="text-align: right;">0.0</td> </tr> </table> | | Serie | 69.0 | Total | 0.0 | | | | | | | | | | | | | | | | | |
| Serie | 69.0 | | | | | | | | | | | | | | | | | | | | | |
| Total | 0.0 | | | | | | | | | | | | | | | | | | | | | |

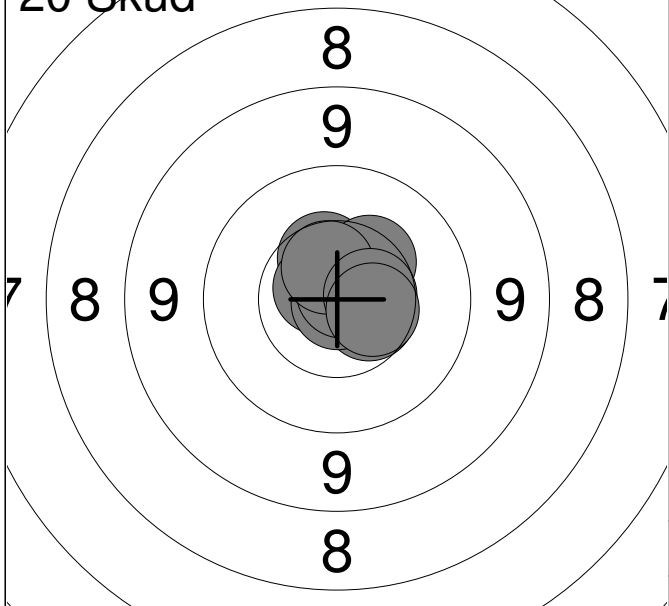
| | | | | | | | | | | | | | | | | | | | | | | | | | | | | | | | |
|---|--|-------|-------|-------|-------|-------|---|----|------|---|----|------|---|----|-------|---|----|-------|---|----|------|---|----|------|---|----|------|---|-----|------|---|
| 20 Skud  | <table style="width:100%; border-collapse: collapse;"> <tr><td style="width:10%;">1:</td><td style="width:15%;">10.5</td><td style="width:10%; text-align: right;">↑</td></tr> <tr><td>2:</td><td>*10.7</td><td style="text-align: right;">↗</td></tr> <tr><td>3:</td><td>10.5</td><td style="text-align: right;">↘</td></tr> <tr><td>4:</td><td>10.6</td><td style="text-align: right;">↗</td></tr> <tr><td>5:</td><td>*10.9</td><td style="text-align: right;">↘</td></tr> <tr><td>6:</td><td>*10.8</td><td style="text-align: right;">↗</td></tr> <tr><td>7:</td><td>10.4</td><td style="text-align: right;">↗</td></tr> <tr><td>8:</td><td>10.6</td><td style="text-align: right;">↑</td></tr> <tr><td>9:</td><td>10.6</td><td style="text-align: right;">→</td></tr> <tr><td>10:</td><td>10.5</td><td style="text-align: right;">→</td></tr> </table> | 1: | 10.5 | ↑ | 2: | *10.7 | ↗ | 3: | 10.5 | ↘ | 4: | 10.6 | ↗ | 5: | *10.9 | ↘ | 6: | *10.8 | ↗ | 7: | 10.4 | ↗ | 8: | 10.6 | ↑ | 9: | 10.6 | → | 10: | 10.5 | → |
| 1: | 10.5 | ↑ | | | | | | | | | | | | | | | | | | | | | | | | | | | | | |
| 2: | *10.7 | ↗ | | | | | | | | | | | | | | | | | | | | | | | | | | | | | |
| 3: | 10.5 | ↘ | | | | | | | | | | | | | | | | | | | | | | | | | | | | | |
| 4: | 10.6 | ↗ | | | | | | | | | | | | | | | | | | | | | | | | | | | | | |
| 5: | *10.9 | ↘ | | | | | | | | | | | | | | | | | | | | | | | | | | | | | |
| 6: | *10.8 | ↗ | | | | | | | | | | | | | | | | | | | | | | | | | | | | | |
| 7: | 10.4 | ↗ | | | | | | | | | | | | | | | | | | | | | | | | | | | | | |
| 8: | 10.6 | ↑ | | | | | | | | | | | | | | | | | | | | | | | | | | | | | |
| 9: | 10.6 | → | | | | | | | | | | | | | | | | | | | | | | | | | | | | | |
| 10: | 10.5 | → | | | | | | | | | | | | | | | | | | | | | | | | | | | | | |
| <table style="width:100%; border-collapse: collapse;"> <tr> <td style="width:45%;">Serie</td> <td style="width:55%; text-align: right;">100.0</td> </tr> <tr> <td>Total</td> <td style="text-align: right;">100.0</td> </tr> </table> | | Serie | 100.0 | Total | 100.0 | | | | | | | | | | | | | | | | | | | | | | | | | | |
| Serie | 100.0 | | | | | | | | | | | | | | | | | | | | | | | | | | | | | | |
| Total | 100.0 | | | | | | | | | | | | | | | | | | | | | | | | | | | | | | |

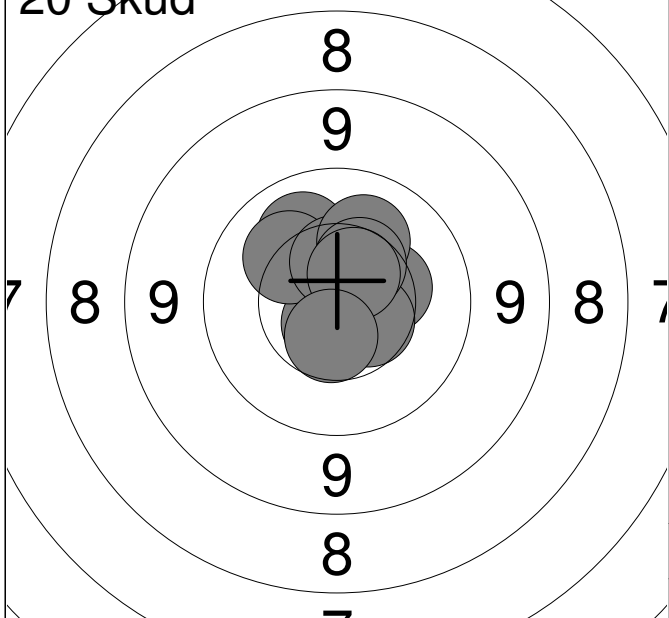
| | | | | | | | | | | | | | | | | | | | | | | | | | | | | | | | |
|---|---|-------|-------|-------|-------|------|---|-----|-------|---|-----|------|---|-----|------|---|-----|------|---|-----|------|---|-----|------|---|-----|------|---|-----|------|---|
| 20 Skud  | <table style="width:100%; border-collapse: collapse;"> <tr><td style="width:10%;">11:</td><td style="width:15%;">10.1</td><td style="width:10%; text-align: right;">↗</td></tr> <tr><td>12:</td><td>10.4</td><td style="text-align: right;">→</td></tr> <tr><td>13:</td><td>*10.7</td><td style="text-align: right;">↘</td></tr> <tr><td>14:</td><td>10.2</td><td style="text-align: right;">↗</td></tr> <tr><td>15:</td><td>10.5</td><td style="text-align: right;">↑</td></tr> <tr><td>16:</td><td>10.5</td><td style="text-align: right;">↘</td></tr> <tr><td>17:</td><td>10.2</td><td style="text-align: right;">↗</td></tr> <tr><td>18:</td><td>10.4</td><td style="text-align: right;">↗</td></tr> <tr><td>19:</td><td>10.6</td><td style="text-align: right;">↗</td></tr> <tr><td>20:</td><td>10.5</td><td style="text-align: right;">↘</td></tr> </table> | 11: | 10.1 | ↗ | 12: | 10.4 | → | 13: | *10.7 | ↘ | 14: | 10.2 | ↗ | 15: | 10.5 | ↑ | 16: | 10.5 | ↘ | 17: | 10.2 | ↗ | 18: | 10.4 | ↗ | 19: | 10.6 | ↗ | 20: | 10.5 | ↘ |
| 11: | 10.1 | ↗ | | | | | | | | | | | | | | | | | | | | | | | | | | | | | |
| 12: | 10.4 | → | | | | | | | | | | | | | | | | | | | | | | | | | | | | | |
| 13: | *10.7 | ↘ | | | | | | | | | | | | | | | | | | | | | | | | | | | | | |
| 14: | 10.2 | ↗ | | | | | | | | | | | | | | | | | | | | | | | | | | | | | |
| 15: | 10.5 | ↑ | | | | | | | | | | | | | | | | | | | | | | | | | | | | | |
| 16: | 10.5 | ↘ | | | | | | | | | | | | | | | | | | | | | | | | | | | | | |
| 17: | 10.2 | ↗ | | | | | | | | | | | | | | | | | | | | | | | | | | | | | |
| 18: | 10.4 | ↗ | | | | | | | | | | | | | | | | | | | | | | | | | | | | | |
| 19: | 10.6 | ↗ | | | | | | | | | | | | | | | | | | | | | | | | | | | | | |
| 20: | 10.5 | ↘ | | | | | | | | | | | | | | | | | | | | | | | | | | | | | |
| <table style="width:100%; border-collapse: collapse;"> <tr> <td style="width:45%;">Serie</td> <td style="width:55%; text-align: right;">100.0</td> </tr> <tr> <td>Total</td> <td style="text-align: right;">200.0</td> </tr> </table> | | Serie | 100.0 | Total | 200.0 | | | | | | | | | | | | | | | | | | | | | | | | | | |
| Serie | 100.0 | | | | | | | | | | | | | | | | | | | | | | | | | | | | | | |
| Total | 200.0 | | | | | | | | | | | | | | | | | | | | | | | | | | | | | | |

| | | | | | | | | | | | | | | | | | | | | | | | | | | | | | | | | | | |
|---------------------|--|------|-----|---|----|-------|---|----|------|---|----|------|---|----|------|---|----|------|---|----|------|---|----|-------|---|----|------|---|--------------|--|------|--------------|--|-----|
| <p>Prøve</p> | <table style="width:100%; border-collapse: collapse;"> <tr><td style="width:10%;">1:</td><td style="width:80%;">9.9</td><td style="width:10%; text-align: center;">↗</td></tr> <tr><td>2:</td><td>*10.8</td><td style="text-align: center;">→</td></tr> <tr><td>3:</td><td>10.1</td><td style="text-align: center;">↖</td></tr> <tr><td>4:</td><td>10.2</td><td style="text-align: center;">↖</td></tr> <tr><td>5:</td><td>10.2</td><td style="text-align: center;">↙</td></tr> <tr><td>6:</td><td>10.2</td><td style="text-align: center;">→</td></tr> <tr><td>7:</td><td>10.5</td><td style="text-align: center;">↗</td></tr> <tr><td>8:</td><td>*10.7</td><td style="text-align: center;">→</td></tr> <tr><td>9:</td><td>10.5</td><td style="text-align: center;">↑</td></tr> <tr><td colspan="2">Serie</td><td style="text-align: right;">89.0</td></tr> <tr><td colspan="2">Total</td><td style="text-align: right;">0.0</td></tr> </table> | 1: | 9.9 | ↗ | 2: | *10.8 | → | 3: | 10.1 | ↖ | 4: | 10.2 | ↖ | 5: | 10.2 | ↙ | 6: | 10.2 | → | 7: | 10.5 | ↗ | 8: | *10.7 | → | 9: | 10.5 | ↑ | Serie | | 89.0 | Total | | 0.0 |
| 1: | 9.9 | ↗ | | | | | | | | | | | | | | | | | | | | | | | | | | | | | | | | |
| 2: | *10.8 | → | | | | | | | | | | | | | | | | | | | | | | | | | | | | | | | | |
| 3: | 10.1 | ↖ | | | | | | | | | | | | | | | | | | | | | | | | | | | | | | | | |
| 4: | 10.2 | ↖ | | | | | | | | | | | | | | | | | | | | | | | | | | | | | | | | |
| 5: | 10.2 | ↙ | | | | | | | | | | | | | | | | | | | | | | | | | | | | | | | | |
| 6: | 10.2 | → | | | | | | | | | | | | | | | | | | | | | | | | | | | | | | | | |
| 7: | 10.5 | ↗ | | | | | | | | | | | | | | | | | | | | | | | | | | | | | | | | |
| 8: | *10.7 | → | | | | | | | | | | | | | | | | | | | | | | | | | | | | | | | | |
| 9: | 10.5 | ↑ | | | | | | | | | | | | | | | | | | | | | | | | | | | | | | | | |
| Serie | | 89.0 | | | | | | | | | | | | | | | | | | | | | | | | | | | | | | | | |
| Total | | 0.0 | | | | | | | | | | | | | | | | | | | | | | | | | | | | | | | | |

| | | | | | | | | | | | | | | | | | | | | | | | | | | | | | | | | | | | | | |
|-----------------------|--|-------|------|---|----|------|---|----|-------|---|----|------|---|----|------|---|----|------|---|----|-------|---|----|------|---|----|------|---|-----|-------|---|--------------|--|-------|--------------|--|-------|
| <p>20 Skud</p> | <table style="width:100%; border-collapse: collapse;"> <tr><td style="width:10%;">1:</td><td style="width:80%;">10.2</td><td style="width:10%; text-align: center;">↗</td></tr> <tr><td>2:</td><td>10.3</td><td style="text-align: center;">↖</td></tr> <tr><td>3:</td><td>*10.8</td><td style="text-align: center;">→</td></tr> <tr><td>4:</td><td>10.1</td><td style="text-align: center;">→</td></tr> <tr><td>5:</td><td>10.5</td><td style="text-align: center;">→</td></tr> <tr><td>6:</td><td>10.1</td><td style="text-align: center;">↗</td></tr> <tr><td>7:</td><td>*10.6</td><td style="text-align: center;">↗</td></tr> <tr><td>8:</td><td>10.4</td><td style="text-align: center;">↑</td></tr> <tr><td>9:</td><td>10.3</td><td style="text-align: center;">→</td></tr> <tr><td>10:</td><td>*10.7</td><td style="text-align: center;">←</td></tr> <tr><td colspan="2">Serie</td><td style="text-align: right;">100.0</td></tr> <tr><td colspan="2">Total</td><td style="text-align: right;">100.0</td></tr> </table> | 1: | 10.2 | ↗ | 2: | 10.3 | ↖ | 3: | *10.8 | → | 4: | 10.1 | → | 5: | 10.5 | → | 6: | 10.1 | ↗ | 7: | *10.6 | ↗ | 8: | 10.4 | ↑ | 9: | 10.3 | → | 10: | *10.7 | ← | Serie | | 100.0 | Total | | 100.0 |
| 1: | 10.2 | ↗ | | | | | | | | | | | | | | | | | | | | | | | | | | | | | | | | | | | |
| 2: | 10.3 | ↖ | | | | | | | | | | | | | | | | | | | | | | | | | | | | | | | | | | | |
| 3: | *10.8 | → | | | | | | | | | | | | | | | | | | | | | | | | | | | | | | | | | | | |
| 4: | 10.1 | → | | | | | | | | | | | | | | | | | | | | | | | | | | | | | | | | | | | |
| 5: | 10.5 | → | | | | | | | | | | | | | | | | | | | | | | | | | | | | | | | | | | | |
| 6: | 10.1 | ↗ | | | | | | | | | | | | | | | | | | | | | | | | | | | | | | | | | | | |
| 7: | *10.6 | ↗ | | | | | | | | | | | | | | | | | | | | | | | | | | | | | | | | | | | |
| 8: | 10.4 | ↑ | | | | | | | | | | | | | | | | | | | | | | | | | | | | | | | | | | | |
| 9: | 10.3 | → | | | | | | | | | | | | | | | | | | | | | | | | | | | | | | | | | | | |
| 10: | *10.7 | ← | | | | | | | | | | | | | | | | | | | | | | | | | | | | | | | | | | | |
| Serie | | 100.0 | | | | | | | | | | | | | | | | | | | | | | | | | | | | | | | | | | | |
| Total | | 100.0 | | | | | | | | | | | | | | | | | | | | | | | | | | | | | | | | | | | |

| | | | | | | | | | | | | | | | | | | | | | | | | | | | | | | | | | | | | | |
|-----------------------|--|-------|------|---|-----|------|---|-----|------|---|-----|------|---|-----|-------|---|-----|------|---|-----|-----|---|-----|------|---|-----|-----|---|-----|------|---|--------------|--|------|--------------|--|-------|
| <p>20 Skud</p> | <table style="width:100%; border-collapse: collapse;"> <tr><td style="width:10%;">11:</td><td style="width:80%;">10.2</td><td style="width:10%; text-align: center;">→</td></tr> <tr><td>12:</td><td>10.5</td><td style="text-align: center;">→</td></tr> <tr><td>13:</td><td>10.6</td><td style="text-align: center;">↓</td></tr> <tr><td>14:</td><td>10.4</td><td style="text-align: center;">↓</td></tr> <tr><td>15:</td><td>*10.7</td><td style="text-align: center;">↑</td></tr> <tr><td>16:</td><td>10.2</td><td style="text-align: center;">↖</td></tr> <tr><td>17:</td><td>9.9</td><td style="text-align: center;">←</td></tr> <tr><td>18:</td><td>10.3</td><td style="text-align: center;">↗</td></tr> <tr><td>19:</td><td>9.9</td><td style="text-align: center;">↖</td></tr> <tr><td>20:</td><td>10.4</td><td style="text-align: center;">↑</td></tr> <tr><td colspan="2">Serie</td><td style="text-align: right;">98.0</td></tr> <tr><td colspan="2">Total</td><td style="text-align: right;">198.0</td></tr> </table> | 11: | 10.2 | → | 12: | 10.5 | → | 13: | 10.6 | ↓ | 14: | 10.4 | ↓ | 15: | *10.7 | ↑ | 16: | 10.2 | ↖ | 17: | 9.9 | ← | 18: | 10.3 | ↗ | 19: | 9.9 | ↖ | 20: | 10.4 | ↑ | Serie | | 98.0 | Total | | 198.0 |
| 11: | 10.2 | → | | | | | | | | | | | | | | | | | | | | | | | | | | | | | | | | | | | |
| 12: | 10.5 | → | | | | | | | | | | | | | | | | | | | | | | | | | | | | | | | | | | | |
| 13: | 10.6 | ↓ | | | | | | | | | | | | | | | | | | | | | | | | | | | | | | | | | | | |
| 14: | 10.4 | ↓ | | | | | | | | | | | | | | | | | | | | | | | | | | | | | | | | | | | |
| 15: | *10.7 | ↑ | | | | | | | | | | | | | | | | | | | | | | | | | | | | | | | | | | | |
| 16: | 10.2 | ↖ | | | | | | | | | | | | | | | | | | | | | | | | | | | | | | | | | | | |
| 17: | 9.9 | ← | | | | | | | | | | | | | | | | | | | | | | | | | | | | | | | | | | | |
| 18: | 10.3 | ↗ | | | | | | | | | | | | | | | | | | | | | | | | | | | | | | | | | | | |
| 19: | 9.9 | ↖ | | | | | | | | | | | | | | | | | | | | | | | | | | | | | | | | | | | |
| 20: | 10.4 | ↑ | | | | | | | | | | | | | | | | | | | | | | | | | | | | | | | | | | | |
| Serie | | 98.0 | | | | | | | | | | | | | | | | | | | | | | | | | | | | | | | | | | | |
| Total | | 198.0 | | | | | | | | | | | | | | | | | | | | | | | | | | | | | | | | | | | |

Hold
29

Skive
6

Hanna Houen Jensen

Vester Hassing Skf.

MB3

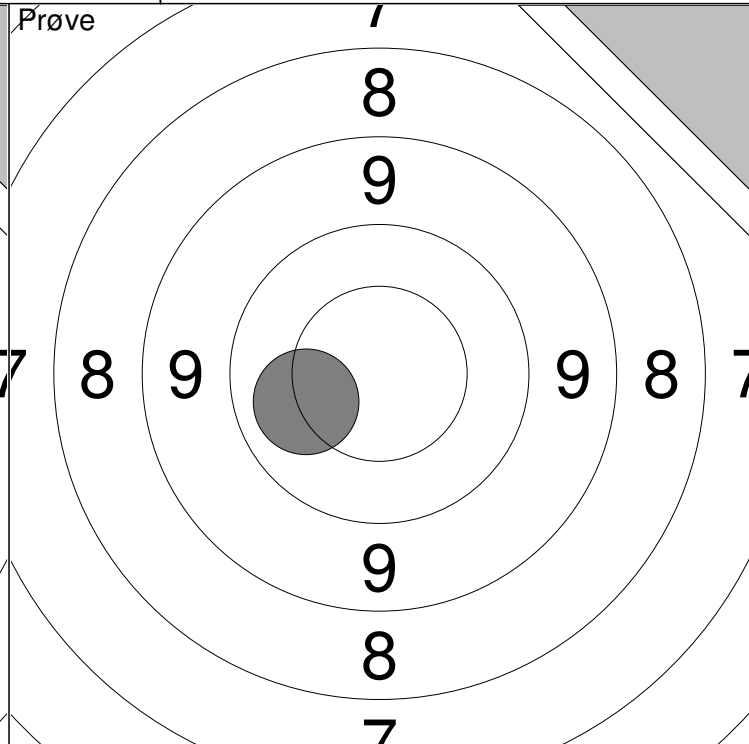
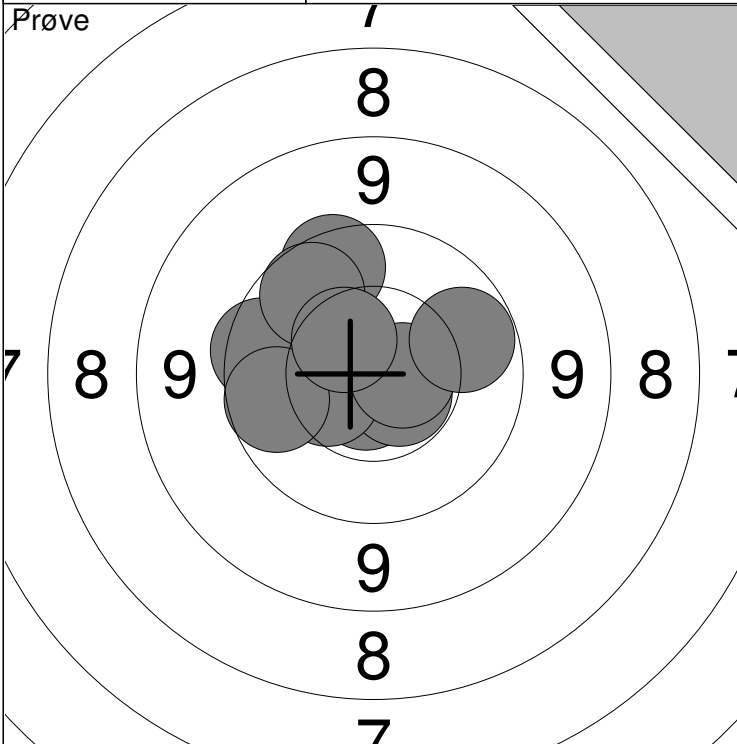

| | | |
|------------|------------|------------|
| 1: *10.7 ↘ | 6: 9.9 ↗ | Serie 96.0 |
| 2: *10.6 ↘ | 7: 9.9 ↖ | |
| 3: 9.8 ↗ | 8: *10.6 → | Total 0.0 |
| 4: 10.4 ↙ | 9: 10.5 ↗ | |
| 5: 9.8 ↖ | 10: 10.0 → | |

| | |
|------------|------------|
| 11: 10.1 ↖ | Serie 10.0 |
| | |
| | Total 0.0 |
| | |

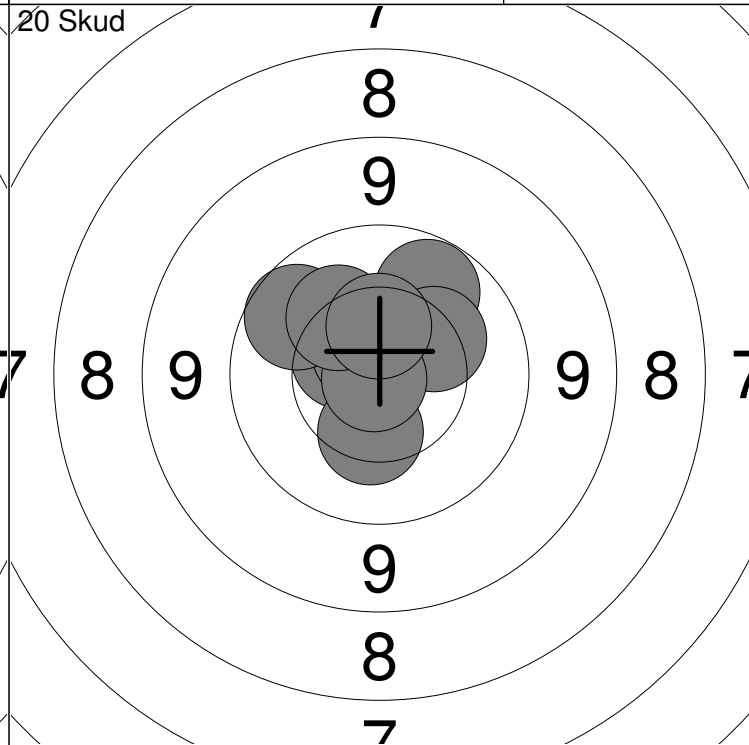
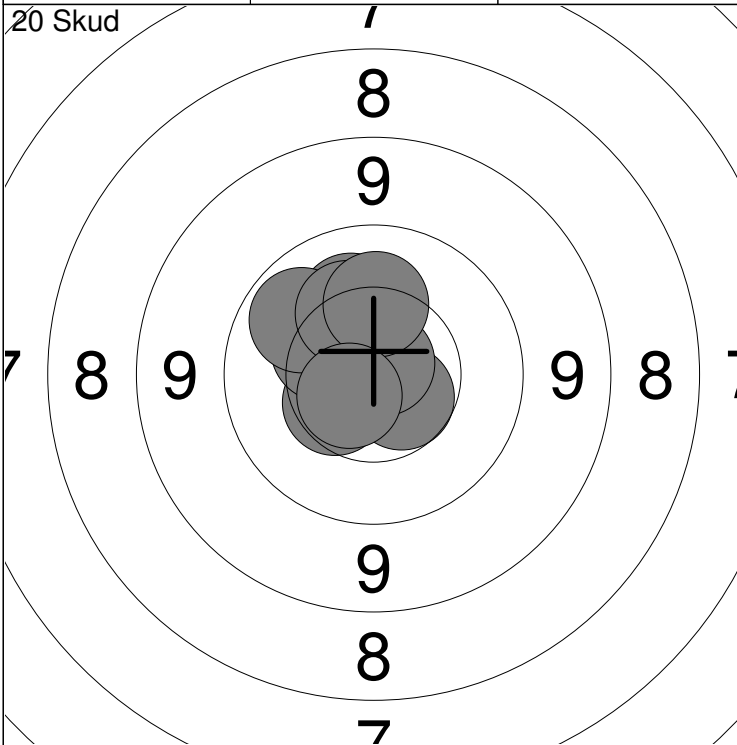

| | | |
|------------|-------------|-------------|
| 1: 10.2 ↗ | 6: 10.4 ↖ | Serie 100.0 |
| 2: 10.6 ↘ | 7: 10.0 ↗ | |
| 3: 10.5 ↙ | 8: 10.3 ↗ | Total 100.0 |
| 4: 10.4 ↗ | 9: 10.2 ↗ | |
| 5: *10.8 ↗ | 10: *10.6 ↖ | |

| | | |
|-------------|-------------|-------------|
| 11: 10.5 ↖ | 16: 10.3 ↗ | Serie 99.0 |
| 12: 10.3 ↘ | 17: *10.9 ↖ | |
| 13: *10.7 ↗ | 18: 9.9 ↖ | Total 199.0 |
| 14: *10.6 ↗ | 19: 10.2 ↗ | |
| 15: 10.0 ↗ | 20: 10.5 ↗ | |

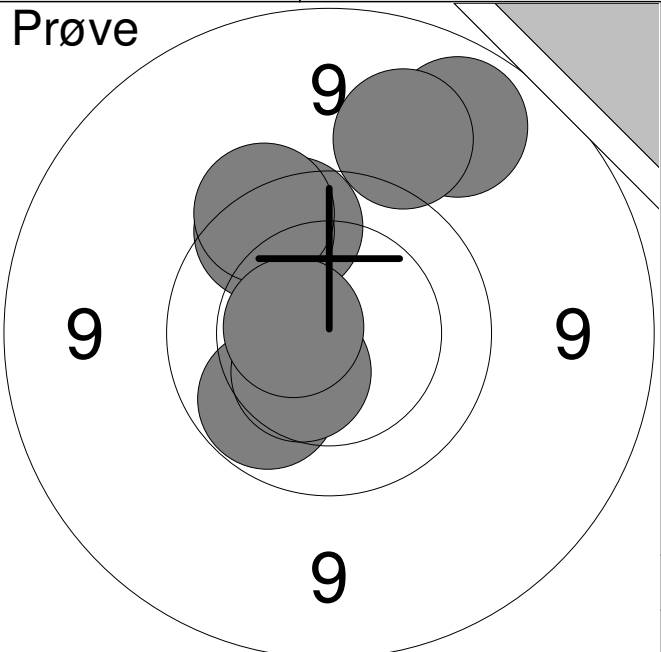
| | | | | | | | | | | | | | | | | | | | | | | | | | |
|--|---|-------|------|-------|-----|------|---|----|-----|---|----|-----|---|----|-----|---|----|-----|---|----|------|---|----|-------|---|
| <p>Prøve</p>  | <table style="width:100%; border-collapse: collapse;"> <tr><td>1:</td><td>9.8</td><td>↑</td></tr> <tr><td>2:</td><td>10.0</td><td>↙</td></tr> <tr><td>3:</td><td>9.8</td><td>↑</td></tr> <tr><td>4:</td><td>9.7</td><td>↑</td></tr> <tr><td>5:</td><td>9.0</td><td>↗</td></tr> <tr><td>6:</td><td>9.2</td><td>↑</td></tr> <tr><td>7:</td><td>10.4</td><td>↙</td></tr> <tr><td>8:</td><td>*10.6</td><td>←</td></tr> </table> | 1: | 9.8 | ↑ | 2: | 10.0 | ↙ | 3: | 9.8 | ↑ | 4: | 9.7 | ↑ | 5: | 9.0 | ↗ | 6: | 9.2 | ↑ | 7: | 10.4 | ↙ | 8: | *10.6 | ← |
| 1: | 9.8 | ↑ | | | | | | | | | | | | | | | | | | | | | | | |
| 2: | 10.0 | ↙ | | | | | | | | | | | | | | | | | | | | | | | |
| 3: | 9.8 | ↑ | | | | | | | | | | | | | | | | | | | | | | | |
| 4: | 9.7 | ↑ | | | | | | | | | | | | | | | | | | | | | | | |
| 5: | 9.0 | ↗ | | | | | | | | | | | | | | | | | | | | | | | |
| 6: | 9.2 | ↑ | | | | | | | | | | | | | | | | | | | | | | | |
| 7: | 10.4 | ↙ | | | | | | | | | | | | | | | | | | | | | | | |
| 8: | *10.6 | ← | | | | | | | | | | | | | | | | | | | | | | | |
| <table style="width:100%; border-collapse: collapse;"> <tr> <td style="width:45%;">Serie</td> <td style="width:55%; text-align: right;">75.0</td> </tr> <tr> <td>Total</td> <td style="text-align: right;">0.0</td> </tr> </table> | | Serie | 75.0 | Total | 0.0 | | | | | | | | | | | | | | | | | | | | |
| Serie | 75.0 | | | | | | | | | | | | | | | | | | | | | | | | |
| Total | 0.0 | | | | | | | | | | | | | | | | | | | | | | | | |

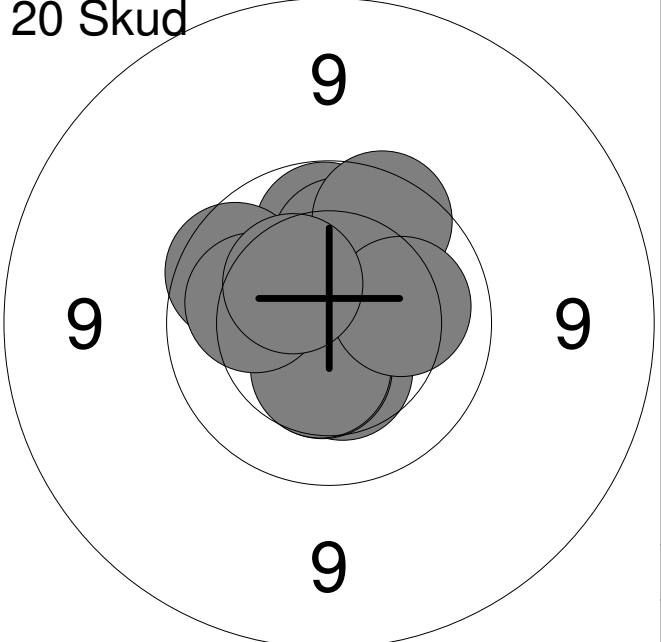
| | | | | | | | | | | | | | | | | | | | | | | | | | | | | | | | |
|---|--|-------|------|-------|------|------|---|----|------|---|----|------|---|----|-----|---|----|------|---|----|-----|---|----|------|---|----|------|---|-----|------|---|
| <p>20 Skud</p>  | <table style="width:100%; border-collapse: collapse;"> <tr><td>1:</td><td>10.4</td><td>↓</td></tr> <tr><td>2:</td><td>10.5</td><td>↓</td></tr> <tr><td>3:</td><td>10.5</td><td>↓</td></tr> <tr><td>4:</td><td>10.0</td><td>↑</td></tr> <tr><td>5:</td><td>9.9</td><td>↗</td></tr> <tr><td>6:</td><td>10.1</td><td>↑</td></tr> <tr><td>7:</td><td>9.8</td><td>↗</td></tr> <tr><td>8:</td><td>10.1</td><td>←</td></tr> <tr><td>9:</td><td>10.2</td><td>→</td></tr> <tr><td>10:</td><td>10.4</td><td>↗</td></tr> </table> | 1: | 10.4 | ↓ | 2: | 10.5 | ↓ | 3: | 10.5 | ↓ | 4: | 10.0 | ↑ | 5: | 9.9 | ↗ | 6: | 10.1 | ↑ | 7: | 9.8 | ↗ | 8: | 10.1 | ← | 9: | 10.2 | → | 10: | 10.4 | ↗ |
| 1: | 10.4 | ↓ | | | | | | | | | | | | | | | | | | | | | | | | | | | | | |
| 2: | 10.5 | ↓ | | | | | | | | | | | | | | | | | | | | | | | | | | | | | |
| 3: | 10.5 | ↓ | | | | | | | | | | | | | | | | | | | | | | | | | | | | | |
| 4: | 10.0 | ↑ | | | | | | | | | | | | | | | | | | | | | | | | | | | | | |
| 5: | 9.9 | ↗ | | | | | | | | | | | | | | | | | | | | | | | | | | | | | |
| 6: | 10.1 | ↑ | | | | | | | | | | | | | | | | | | | | | | | | | | | | | |
| 7: | 9.8 | ↗ | | | | | | | | | | | | | | | | | | | | | | | | | | | | | |
| 8: | 10.1 | ← | | | | | | | | | | | | | | | | | | | | | | | | | | | | | |
| 9: | 10.2 | → | | | | | | | | | | | | | | | | | | | | | | | | | | | | | |
| 10: | 10.4 | ↗ | | | | | | | | | | | | | | | | | | | | | | | | | | | | | |
| <table style="width:100%; border-collapse: collapse;"> <tr> <td style="width:45%;">Serie</td> <td style="width:55%; text-align: right;">98.0</td> </tr> <tr> <td>Total</td> <td style="text-align: right;">98.0</td> </tr> </table> | | Serie | 98.0 | Total | 98.0 | | | | | | | | | | | | | | | | | | | | | | | | | | |
| Serie | 98.0 | | | | | | | | | | | | | | | | | | | | | | | | | | | | | | |
| Total | 98.0 | | | | | | | | | | | | | | | | | | | | | | | | | | | | | | |

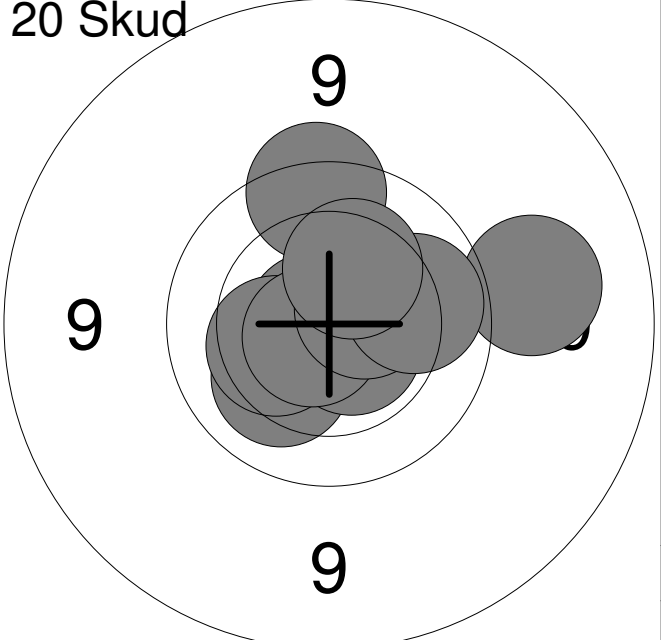
| | | | | | | | | | | | | | | | | | | | | | | | | | | | | | | | |
|--|---|-------|------|-------|-------|------|---|-----|-------|---|-----|-------|---|-----|------|---|-----|-----|---|-----|-------|---|-----|-------|---|-----|------|---|-----|------|---|
| <p>20 Skud</p>  | <table style="width:100%; border-collapse: collapse;"> <tr><td>11:</td><td>9.2</td><td>→</td></tr> <tr><td>12:</td><td>10.2</td><td>↙</td></tr> <tr><td>13:</td><td>*10.8</td><td>←</td></tr> <tr><td>14:</td><td>*10.6</td><td>↘</td></tr> <tr><td>15:</td><td>10.3</td><td>←</td></tr> <tr><td>16:</td><td>9.7</td><td>↑</td></tr> <tr><td>17:</td><td>*10.7</td><td>↙</td></tr> <tr><td>18:</td><td>*10.5</td><td>→</td></tr> <tr><td>19:</td><td>10.0</td><td>→</td></tr> <tr><td>20:</td><td>10.3</td><td>↑</td></tr> </table> | 11: | 9.2 | → | 12: | 10.2 | ↙ | 13: | *10.8 | ← | 14: | *10.6 | ↘ | 15: | 10.3 | ← | 16: | 9.7 | ↑ | 17: | *10.7 | ↙ | 18: | *10.5 | → | 19: | 10.0 | → | 20: | 10.3 | ↑ |
| 11: | 9.2 | → | | | | | | | | | | | | | | | | | | | | | | | | | | | | | |
| 12: | 10.2 | ↙ | | | | | | | | | | | | | | | | | | | | | | | | | | | | | |
| 13: | *10.8 | ← | | | | | | | | | | | | | | | | | | | | | | | | | | | | | |
| 14: | *10.6 | ↘ | | | | | | | | | | | | | | | | | | | | | | | | | | | | | |
| 15: | 10.3 | ← | | | | | | | | | | | | | | | | | | | | | | | | | | | | | |
| 16: | 9.7 | ↑ | | | | | | | | | | | | | | | | | | | | | | | | | | | | | |
| 17: | *10.7 | ↙ | | | | | | | | | | | | | | | | | | | | | | | | | | | | | |
| 18: | *10.5 | → | | | | | | | | | | | | | | | | | | | | | | | | | | | | | |
| 19: | 10.0 | → | | | | | | | | | | | | | | | | | | | | | | | | | | | | | |
| 20: | 10.3 | ↑ | | | | | | | | | | | | | | | | | | | | | | | | | | | | | |
| <table style="width:100%; border-collapse: collapse;"> <tr> <td style="width:45%;">Serie</td> <td style="width:55%; text-align: right;">98.0</td> </tr> <tr> <td>Total</td> <td style="text-align: right;">196.0</td> </tr> </table> | | Serie | 98.0 | Total | 196.0 | | | | | | | | | | | | | | | | | | | | | | | | | | |
| Serie | 98.0 | | | | | | | | | | | | | | | | | | | | | | | | | | | | | | |
| Total | 196.0 | | | | | | | | | | | | | | | | | | | | | | | | | | | | | | |

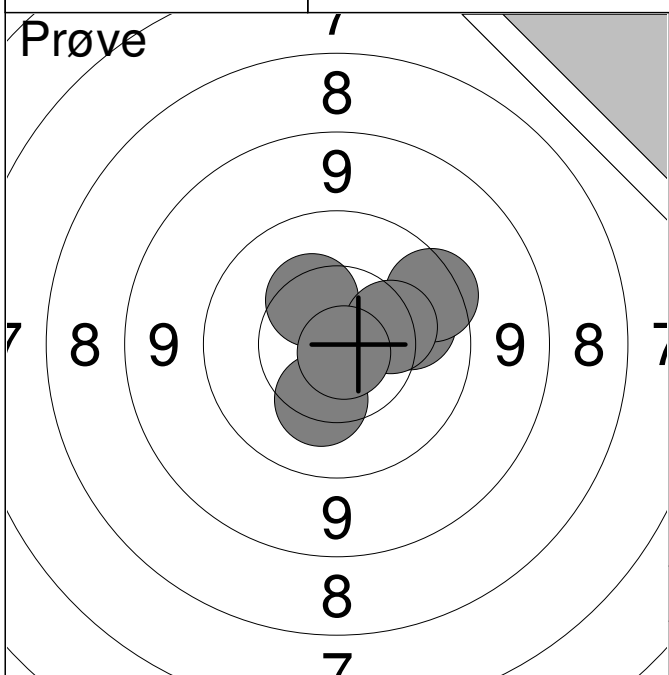

| | | |
|-------|-------|------|
| 1: | 10.1 | → |
| 2: | 9.7 | → |
| 3: | 10.4 | ↗ |
| 4: | 10.3 | → |
| 5: | 10.3 | ↘ |
| 6: | *10.8 | ↘ |
| Serie | | 59.0 |
| Total | | 0.0 |

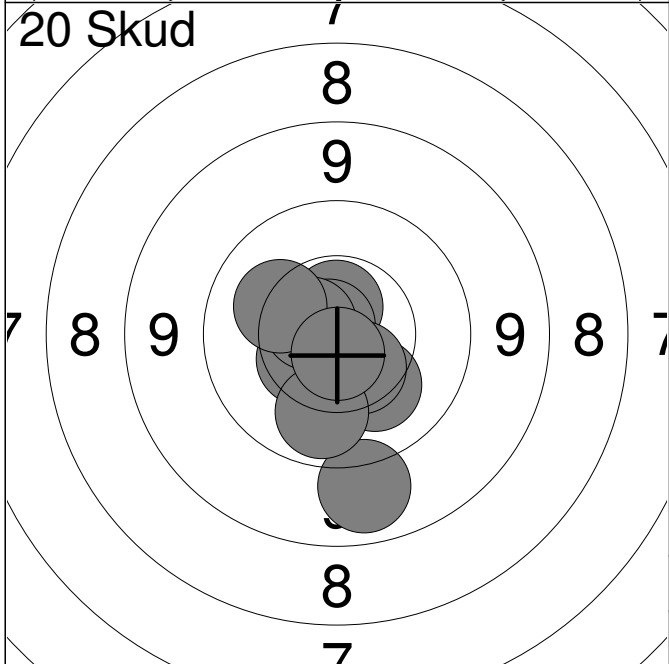

| | | |
|-------|-------|------|
| 1: | *10.6 | ↑ |
| 2: | *10.8 | ↗ |
| 3: | 10.2 | ↘ |
| 4: | 10.5 | ↘ |
| 5: | 9.1 | ↘ |
| 6: | 10.5 | ↖ |
| 7: | *10.6 | ↗ |
| 8: | 10.0 | ↘ |
| 9: | 10.2 | ↗ |
| 10: | *10.7 | ↘ |
| Serie | | 99.0 |
| Total | | 99.0 |

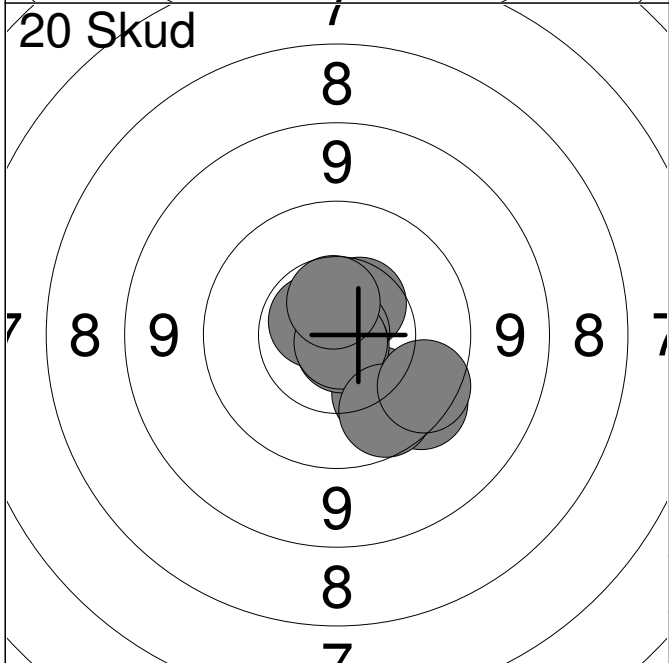

| | | |
|-------|-------|-------|
| 11: | 10.1 | ↘ |
| 12: | 10.5 | ↗ |
| 13: | *10.9 | → |
| 14: | *10.8 | ↘ |
| 15: | *10.7 | ↗ |
| 16: | 9.7 | ↘ |
| 17: | *10.9 | ↘ |
| 18: | 9.9 | ↘ |
| 19: | 10.6 | ↗ |
| 20: | 9.8 | ↘ |
| Serie | | 97.0 |
| Total | | 196.0 |

Hold
29

Skive
9

Rasmus Klitgaard

Hjørring Skytteforening

MJ2

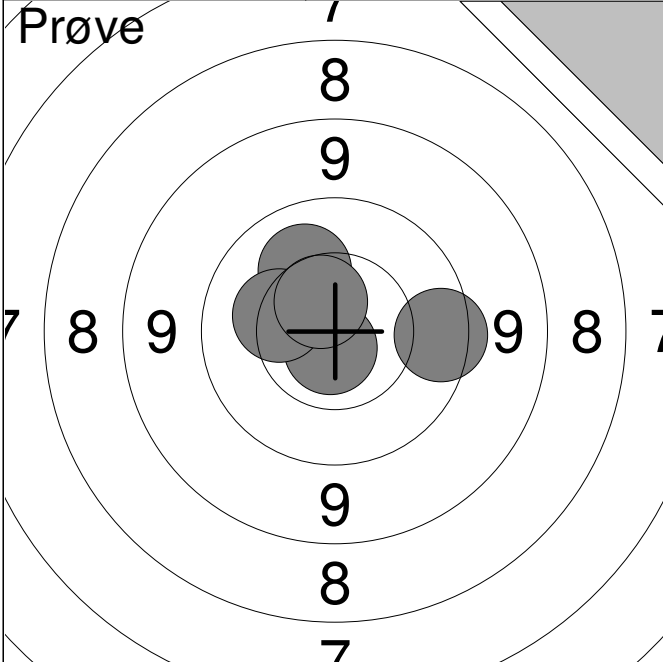

- 1: *10.8
- 2: 10.2
- 3: 9.7
- 4: 10.3
- 5: 10.6

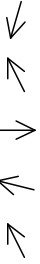

| | |
|-------|------|
| Serie | 49.0 |
| Total | 0.0 |

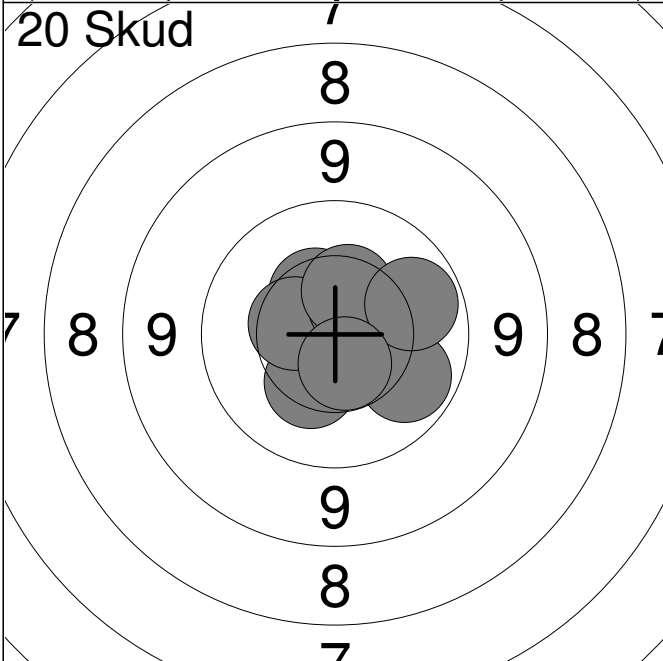

- 1: *10.8
- 2: *10.7
- 3: 10.4
- 4: 10.3
- 5: 10.5
- 6: 10.5
- 7: 10.0
- 8: 10.4
- 9: 10.0
- 10: *10.6



| | |
|-------|-------|
| Serie | 100.0 |
| Total | 100.0 |

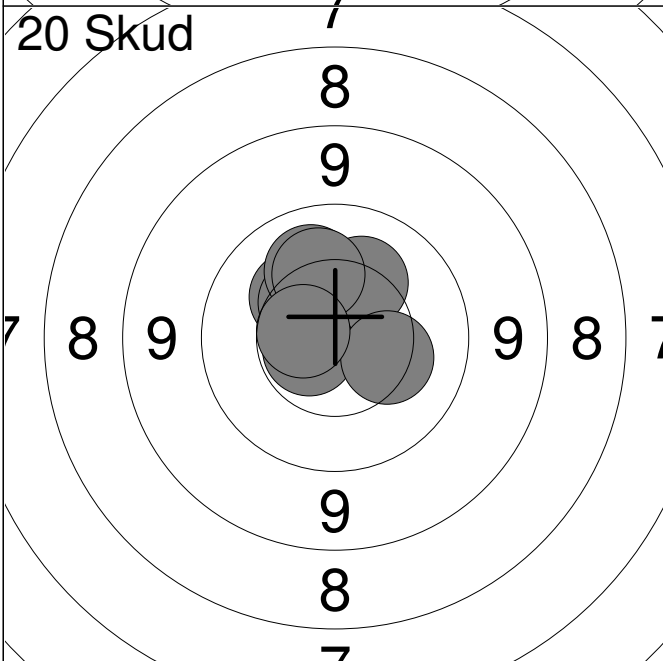

- 11: 10.3
- 12: *10.6
- 13: *10.8
- 14: 10.4
- 15: 10.2
- 16: *10.6
- 17: 10.1
- 18: 10.3
- 19: 10.2
- 20: 10.6

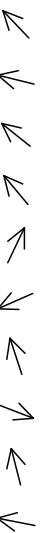

| | |
|-------|-------|
| Serie | 100.0 |
| Total | 200.0 |

| | | | | | | | | | | | | | | | | | | | | | | |
|---|---|-------|-------|------|-------|-----|-----|----|------|---|----|-------|---|----|-----|---|----|-----|---|----|-------|---|
| <p>Prøve</p> | <table style="width:100%; border-collapse: collapse;"> <tr><td style="width:10%;">1:</td><td style="width:20%;">*10.7</td><td style="width:10%; text-align: right;">↓</td></tr> <tr><td>2:</td><td>9.7</td><td style="text-align: right;">↙</td></tr> <tr><td>3:</td><td>10.1</td><td style="text-align: right;">→</td></tr> <tr><td>4:</td><td>*10.6</td><td style="text-align: right;">↘</td></tr> <tr><td>5:</td><td>9.8</td><td style="text-align: right;">↖</td></tr> <tr><td>6:</td><td>9.9</td><td style="text-align: right;">↗</td></tr> <tr><td>7:</td><td>*10.7</td><td style="text-align: right;">↑</td></tr> </table> | 1: | *10.7 | ↓ | 2: | 9.7 | ↙ | 3: | 10.1 | → | 4: | *10.6 | ↘ | 5: | 9.8 | ↖ | 6: | 9.9 | ↗ | 7: | *10.7 | ↑ |
| 1: | *10.7 | ↓ | | | | | | | | | | | | | | | | | | | | |
| 2: | 9.7 | ↙ | | | | | | | | | | | | | | | | | | | | |
| 3: | 10.1 | → | | | | | | | | | | | | | | | | | | | | |
| 4: | *10.6 | ↘ | | | | | | | | | | | | | | | | | | | | |
| 5: | 9.8 | ↖ | | | | | | | | | | | | | | | | | | | | |
| 6: | 9.9 | ↗ | | | | | | | | | | | | | | | | | | | | |
| 7: | *10.7 | ↑ | | | | | | | | | | | | | | | | | | | | |
| <table style="width:100%; border-collapse: collapse;"> <tr> <td style="width:10%;">Serie</td> <td style="width:80%;"></td> <td style="width:10%; text-align: right;">67.0</td> </tr> <tr> <td>Total</td> <td></td> <td style="text-align: right;">0.0</td> </tr> </table> | | Serie | | 67.0 | Total | | 0.0 | | | | | | | | | | | | | | | |
| Serie | | 67.0 | | | | | | | | | | | | | | | | | | | | |
| Total | | 0.0 | | | | | | | | | | | | | | | | | | | | |

| | | | | | | | | | | | | | | | | | | | | | | | | | | | | | | | |
|--|---|-------|------|------|-------|------|------|----|------|---|----|-----|---|----|------|---|----|-------|---|----|------|---|----|-----|---|----|-----|---|-----|------|---|
| <p>20 Skud</p> | <table style="width:100%; border-collapse: collapse;"> <tr><td style="width:10%;">1:</td><td style="width:20%;">10.2</td><td style="width:10%; text-align: right;">↖</td></tr> <tr><td>2:</td><td>10.4</td><td style="text-align: right;">↙</td></tr> <tr><td>3:</td><td>10.1</td><td style="text-align: right;">↘</td></tr> <tr><td>4:</td><td>9.1</td><td style="text-align: right;">↖</td></tr> <tr><td>5:</td><td>10.0</td><td style="text-align: right;">↗</td></tr> <tr><td>6:</td><td>*10.6</td><td style="text-align: right;">↗</td></tr> <tr><td>7:</td><td>10.4</td><td style="text-align: right;">↘</td></tr> <tr><td>8:</td><td>9.8</td><td style="text-align: right;">→</td></tr> <tr><td>9:</td><td>9.8</td><td style="text-align: right;">↗</td></tr> <tr><td>10:</td><td>10.0</td><td style="text-align: right;">→</td></tr> </table> | 1: | 10.2 | ↖ | 2: | 10.4 | ↙ | 3: | 10.1 | ↘ | 4: | 9.1 | ↖ | 5: | 10.0 | ↗ | 6: | *10.6 | ↗ | 7: | 10.4 | ↘ | 8: | 9.8 | → | 9: | 9.8 | ↗ | 10: | 10.0 | → |
| 1: | 10.2 | ↖ | | | | | | | | | | | | | | | | | | | | | | | | | | | | | |
| 2: | 10.4 | ↙ | | | | | | | | | | | | | | | | | | | | | | | | | | | | | |
| 3: | 10.1 | ↘ | | | | | | | | | | | | | | | | | | | | | | | | | | | | | |
| 4: | 9.1 | ↖ | | | | | | | | | | | | | | | | | | | | | | | | | | | | | |
| 5: | 10.0 | ↗ | | | | | | | | | | | | | | | | | | | | | | | | | | | | | |
| 6: | *10.6 | ↗ | | | | | | | | | | | | | | | | | | | | | | | | | | | | | |
| 7: | 10.4 | ↘ | | | | | | | | | | | | | | | | | | | | | | | | | | | | | |
| 8: | 9.8 | → | | | | | | | | | | | | | | | | | | | | | | | | | | | | | |
| 9: | 9.8 | ↗ | | | | | | | | | | | | | | | | | | | | | | | | | | | | | |
| 10: | 10.0 | → | | | | | | | | | | | | | | | | | | | | | | | | | | | | | |
| <table style="width:100%; border-collapse: collapse;"> <tr> <td style="width:10%;">Serie</td> <td style="width:80%;"></td> <td style="width:10%; text-align: right;">97.0</td> </tr> <tr> <td>Total</td> <td></td> <td style="text-align: right;">97.0</td> </tr> </table> | | Serie | | 97.0 | Total | | 97.0 | | | | | | | | | | | | | | | | | | | | | | | | |
| Serie | | 97.0 | | | | | | | | | | | | | | | | | | | | | | | | | | | | | |
| Total | | 97.0 | | | | | | | | | | | | | | | | | | | | | | | | | | | | | |

| | | | | | | | | | | | | | | | | | | | | | | | | | | | | | | | |
|---|---|-------|-----|------|-------|-----|-------|-----|-------|---|-----|-----|---|-----|------|---|-----|-------|---|-----|-----|---|-----|-----|---|-----|-----|---|-----|-----|---|
| <p>20 Skud</p> | <table style="width:100%; border-collapse: collapse;"> <tr><td style="width:10%;">11:</td><td style="width:20%;">9.8</td><td style="width:10%; text-align: right;">↖</td></tr> <tr><td>12:</td><td>9.1</td><td style="text-align: right;">↖</td></tr> <tr><td>13:</td><td>*10.7</td><td style="text-align: right;">↗</td></tr> <tr><td>14:</td><td>9.5</td><td style="text-align: right;">→</td></tr> <tr><td>15:</td><td>10.4</td><td style="text-align: right;">↗</td></tr> <tr><td>16:</td><td>*10.7</td><td style="text-align: right;">↗</td></tr> <tr><td>17:</td><td>9.9</td><td style="text-align: right;">→</td></tr> <tr><td>18:</td><td>9.6</td><td style="text-align: right;">↘</td></tr> <tr><td>19:</td><td>9.4</td><td style="text-align: right;">↗</td></tr> <tr><td>20:</td><td>9.7</td><td style="text-align: right;">↗</td></tr> </table> | 11: | 9.8 | ↖ | 12: | 9.1 | ↖ | 13: | *10.7 | ↗ | 14: | 9.5 | → | 15: | 10.4 | ↗ | 16: | *10.7 | ↗ | 17: | 9.9 | → | 18: | 9.6 | ↘ | 19: | 9.4 | ↗ | 20: | 9.7 | ↗ |
| 11: | 9.8 | ↖ | | | | | | | | | | | | | | | | | | | | | | | | | | | | | |
| 12: | 9.1 | ↖ | | | | | | | | | | | | | | | | | | | | | | | | | | | | | |
| 13: | *10.7 | ↗ | | | | | | | | | | | | | | | | | | | | | | | | | | | | | |
| 14: | 9.5 | → | | | | | | | | | | | | | | | | | | | | | | | | | | | | | |
| 15: | 10.4 | ↗ | | | | | | | | | | | | | | | | | | | | | | | | | | | | | |
| 16: | *10.7 | ↗ | | | | | | | | | | | | | | | | | | | | | | | | | | | | | |
| 17: | 9.9 | → | | | | | | | | | | | | | | | | | | | | | | | | | | | | | |
| 18: | 9.6 | ↘ | | | | | | | | | | | | | | | | | | | | | | | | | | | | | |
| 19: | 9.4 | ↗ | | | | | | | | | | | | | | | | | | | | | | | | | | | | | |
| 20: | 9.7 | ↗ | | | | | | | | | | | | | | | | | | | | | | | | | | | | | |
| <table style="width:100%; border-collapse: collapse;"> <tr> <td style="width:10%;">Serie</td> <td style="width:80%;"></td> <td style="width:10%; text-align: right;">93.0</td> </tr> <tr> <td>Total</td> <td></td> <td style="text-align: right;">190.0</td> </tr> </table> | | Serie | | 93.0 | Total | | 190.0 | | | | | | | | | | | | | | | | | | | | | | | | |
| Serie | | 93.0 | | | | | | | | | | | | | | | | | | | | | | | | | | | | | |
| Total | | 190.0 | | | | | | | | | | | | | | | | | | | | | | | | | | | | | |

| | | | | | | | | | | | | | | | | | | | | | | | | | |
|---|---|-------|------|-------|----|-----|-----|----|-----|---|----|-----|---|----|-----|---|----|-----|---|----|-----|---|----|-------|---|
| <p>Prøve</p> | <table style="width:100%; border-collapse: collapse;"> <tr><td style="text-align: right;">1:</td><td style="text-align: right;">9.8</td><td style="text-align: right;">↓</td></tr> <tr><td style="text-align: right;">2:</td><td style="text-align: right;">9.3</td><td style="text-align: right;">→</td></tr> <tr><td style="text-align: right;">3:</td><td style="text-align: right;">8.8</td><td style="text-align: right;">→</td></tr> <tr><td style="text-align: right;">4:</td><td style="text-align: right;">9.2</td><td style="text-align: right;">↘</td></tr> <tr><td style="text-align: right;">5:</td><td style="text-align: right;">9.7</td><td style="text-align: right;">↙</td></tr> <tr><td style="text-align: right;">6:</td><td style="text-align: right;">9.5</td><td style="text-align: right;">↗</td></tr> <tr><td style="text-align: right;">7:</td><td style="text-align: right;">9.4</td><td style="text-align: right;">→</td></tr> <tr><td style="text-align: right;">8:</td><td style="text-align: right;">*10.8</td><td style="text-align: right;">↑</td></tr> </table> | 1: | 9.8 | ↓ | 2: | 9.3 | → | 3: | 8.8 | → | 4: | 9.2 | ↘ | 5: | 9.7 | ↙ | 6: | 9.5 | ↗ | 7: | 9.4 | → | 8: | *10.8 | ↑ |
| 1: | 9.8 | ↓ | | | | | | | | | | | | | | | | | | | | | | | |
| 2: | 9.3 | → | | | | | | | | | | | | | | | | | | | | | | | |
| 3: | 8.8 | → | | | | | | | | | | | | | | | | | | | | | | | |
| 4: | 9.2 | ↘ | | | | | | | | | | | | | | | | | | | | | | | |
| 5: | 9.7 | ↙ | | | | | | | | | | | | | | | | | | | | | | | |
| 6: | 9.5 | ↗ | | | | | | | | | | | | | | | | | | | | | | | |
| 7: | 9.4 | → | | | | | | | | | | | | | | | | | | | | | | | |
| 8: | *10.8 | ↑ | | | | | | | | | | | | | | | | | | | | | | | |
| <table style="width:100%; border-collapse: collapse;"> <tr> <td style="width:45%;">Serie</td> <td style="text-align: right;">72.0</td> </tr> <tr> <td colspan="2" style="border-top: 1px solid black;">Total</td> </tr> <tr> <td></td> <td style="text-align: right;">0.0</td> </tr> </table> | | Serie | 72.0 | Total | | | 0.0 | | | | | | | | | | | | | | | | | | |
| Serie | 72.0 | | | | | | | | | | | | | | | | | | | | | | | | |
| Total | | | | | | | | | | | | | | | | | | | | | | | | | |
| | 0.0 | | | | | | | | | | | | | | | | | | | | | | | | |

| | | | | | | | | | | | | | | | | | | | | | | | | | | | | | | | |
|--|--|-------|------|-------|----|-----|------|----|-----|---|----|------|---|----|-----|---|----|-------|---|----|-----|---|----|-----|---|----|------|---|-----|-------|---|
| <p>20 Skud</p> | <table style="width:100%; border-collapse: collapse;"> <tr><td style="text-align: right;">1:</td><td style="text-align: right;">8.8</td><td style="text-align: right;">↙</td></tr> <tr><td style="text-align: right;">2:</td><td style="text-align: right;">9.3</td><td style="text-align: right;">↓</td></tr> <tr><td style="text-align: right;">3:</td><td style="text-align: right;">9.2</td><td style="text-align: right;">↖</td></tr> <tr><td style="text-align: right;">4:</td><td style="text-align: right;">10.3</td><td style="text-align: right;">↑</td></tr> <tr><td style="text-align: right;">5:</td><td style="text-align: right;">9.7</td><td style="text-align: right;">↓</td></tr> <tr><td style="text-align: right;">6:</td><td style="text-align: right;">*10.5</td><td style="text-align: right;">↙</td></tr> <tr><td style="text-align: right;">7:</td><td style="text-align: right;">9.4</td><td style="text-align: right;">↙</td></tr> <tr><td style="text-align: right;">8:</td><td style="text-align: right;">9.8</td><td style="text-align: right;">←</td></tr> <tr><td style="text-align: right;">9:</td><td style="text-align: right;">10.4</td><td style="text-align: right;">→</td></tr> <tr><td style="text-align: right;">10:</td><td style="text-align: right;">*10.9</td><td style="text-align: right;">↙</td></tr> </table> | 1: | 8.8 | ↙ | 2: | 9.3 | ↓ | 3: | 9.2 | ↖ | 4: | 10.3 | ↑ | 5: | 9.7 | ↓ | 6: | *10.5 | ↙ | 7: | 9.4 | ↙ | 8: | 9.8 | ← | 9: | 10.4 | → | 10: | *10.9 | ↙ |
| 1: | 8.8 | ↙ | | | | | | | | | | | | | | | | | | | | | | | | | | | | | |
| 2: | 9.3 | ↓ | | | | | | | | | | | | | | | | | | | | | | | | | | | | | |
| 3: | 9.2 | ↖ | | | | | | | | | | | | | | | | | | | | | | | | | | | | | |
| 4: | 10.3 | ↑ | | | | | | | | | | | | | | | | | | | | | | | | | | | | | |
| 5: | 9.7 | ↓ | | | | | | | | | | | | | | | | | | | | | | | | | | | | | |
| 6: | *10.5 | ↙ | | | | | | | | | | | | | | | | | | | | | | | | | | | | | |
| 7: | 9.4 | ↙ | | | | | | | | | | | | | | | | | | | | | | | | | | | | | |
| 8: | 9.8 | ← | | | | | | | | | | | | | | | | | | | | | | | | | | | | | |
| 9: | 10.4 | → | | | | | | | | | | | | | | | | | | | | | | | | | | | | | |
| 10: | *10.9 | ↙ | | | | | | | | | | | | | | | | | | | | | | | | | | | | | |
| <table style="width:100%; border-collapse: collapse;"> <tr> <td style="width:45%;">Serie</td> <td style="text-align: right;">93.0</td> </tr> <tr> <td colspan="2" style="border-top: 1px solid black;">Total</td> </tr> <tr> <td></td> <td style="text-align: right;">93.0</td> </tr> </table> | | Serie | 93.0 | Total | | | 93.0 | | | | | | | | | | | | | | | | | | | | | | | | |
| Serie | 93.0 | | | | | | | | | | | | | | | | | | | | | | | | | | | | | | |
| Total | | | | | | | | | | | | | | | | | | | | | | | | | | | | | | | |
| | 93.0 | | | | | | | | | | | | | | | | | | | | | | | | | | | | | | |

| | | | | | | | | | | | | | | | | | | | | | | | | | | | | | | | |
|---|---|-------|------|-------|-----|-----|-------|-----|-----|---|-----|-----|---|-----|-----|---|-----|------|---|-----|-----|---|-----|-----|---|-----|-------|---|-----|------|---|
| <p>20 Skud</p> | <table style="width:100%; border-collapse: collapse;"> <tr><td style="text-align: right;">11:</td><td style="text-align: right;">9.9</td><td style="text-align: right;">↓</td></tr> <tr><td style="text-align: right;">12:</td><td style="text-align: right;">9.7</td><td style="text-align: right;">→</td></tr> <tr><td style="text-align: right;">13:</td><td style="text-align: right;">9.7</td><td style="text-align: right;">↗</td></tr> <tr><td style="text-align: right;">14:</td><td style="text-align: right;">9.6</td><td style="text-align: right;">↙</td></tr> <tr><td style="text-align: right;">15:</td><td style="text-align: right;">9.1</td><td style="text-align: right;">↙</td></tr> <tr><td style="text-align: right;">16:</td><td style="text-align: right;">10.1</td><td style="text-align: right;">↓</td></tr> <tr><td style="text-align: right;">17:</td><td style="text-align: right;">8.8</td><td style="text-align: right;">↙</td></tr> <tr><td style="text-align: right;">18:</td><td style="text-align: right;">9.7</td><td style="text-align: right;">↙</td></tr> <tr><td style="text-align: right;">19:</td><td style="text-align: right;">*10.8</td><td style="text-align: right;">↗</td></tr> <tr><td style="text-align: right;">20:</td><td style="text-align: right;">10.5</td><td style="text-align: right;">↑</td></tr> </table> | 11: | 9.9 | ↓ | 12: | 9.7 | → | 13: | 9.7 | ↗ | 14: | 9.6 | ↙ | 15: | 9.1 | ↙ | 16: | 10.1 | ↓ | 17: | 8.8 | ↙ | 18: | 9.7 | ↙ | 19: | *10.8 | ↗ | 20: | 10.5 | ↑ |
| 11: | 9.9 | ↓ | | | | | | | | | | | | | | | | | | | | | | | | | | | | | |
| 12: | 9.7 | → | | | | | | | | | | | | | | | | | | | | | | | | | | | | | |
| 13: | 9.7 | ↗ | | | | | | | | | | | | | | | | | | | | | | | | | | | | | |
| 14: | 9.6 | ↙ | | | | | | | | | | | | | | | | | | | | | | | | | | | | | |
| 15: | 9.1 | ↙ | | | | | | | | | | | | | | | | | | | | | | | | | | | | | |
| 16: | 10.1 | ↓ | | | | | | | | | | | | | | | | | | | | | | | | | | | | | |
| 17: | 8.8 | ↙ | | | | | | | | | | | | | | | | | | | | | | | | | | | | | |
| 18: | 9.7 | ↙ | | | | | | | | | | | | | | | | | | | | | | | | | | | | | |
| 19: | *10.8 | ↗ | | | | | | | | | | | | | | | | | | | | | | | | | | | | | |
| 20: | 10.5 | ↑ | | | | | | | | | | | | | | | | | | | | | | | | | | | | | |
| <table style="width:100%; border-collapse: collapse;"> <tr> <td style="width:45%;">Serie</td> <td style="text-align: right;">92.0</td> </tr> <tr> <td colspan="2" style="border-top: 1px solid black;">Total</td> </tr> <tr> <td></td> <td style="text-align: right;">185.0</td> </tr> </table> | | Serie | 92.0 | Total | | | 185.0 | | | | | | | | | | | | | | | | | | | | | | | | |
| Serie | 92.0 | | | | | | | | | | | | | | | | | | | | | | | | | | | | | | |
| Total | | | | | | | | | | | | | | | | | | | | | | | | | | | | | | | |
| | 185.0 | | | | | | | | | | | | | | | | | | | | | | | | | | | | | | |

| | | | | | | | | | | | | | | | | | | | | | | | | | | | | |
|---|--|-------|------|------|-------|-----|-----|----|-------|---|----|------|---|----|------|---|----|------|---|----|------|---|----|-----|---|----|-------|---|
| <p>Prøve</p> | <table style="width:100%; border-collapse: collapse;"> <tr><td style="width:10%;">1:</td><td style="width:10%;">10.4</td><td style="width:10%; text-align: center;">↗</td></tr> <tr><td>2:</td><td>9.5</td><td style="text-align: center;">↑</td></tr> <tr><td>3:</td><td>*10.6</td><td style="text-align: center;">←</td></tr> <tr><td>4:</td><td>10.6</td><td style="text-align: center;">↙</td></tr> <tr><td>5:</td><td>10.0</td><td style="text-align: center;">↑</td></tr> <tr><td>6:</td><td>10.3</td><td style="text-align: center;">↑</td></tr> <tr><td>7:</td><td>10.2</td><td style="text-align: center;">←</td></tr> <tr><td>8:</td><td>9.7</td><td style="text-align: center;">↙</td></tr> <tr><td>9:</td><td>*10.6</td><td style="text-align: center;">↘</td></tr> </table> | 1: | 10.4 | ↗ | 2: | 9.5 | ↑ | 3: | *10.6 | ← | 4: | 10.6 | ↙ | 5: | 10.0 | ↑ | 6: | 10.3 | ↑ | 7: | 10.2 | ← | 8: | 9.7 | ↙ | 9: | *10.6 | ↘ |
| 1: | 10.4 | ↗ | | | | | | | | | | | | | | | | | | | | | | | | | | |
| 2: | 9.5 | ↑ | | | | | | | | | | | | | | | | | | | | | | | | | | |
| 3: | *10.6 | ← | | | | | | | | | | | | | | | | | | | | | | | | | | |
| 4: | 10.6 | ↙ | | | | | | | | | | | | | | | | | | | | | | | | | | |
| 5: | 10.0 | ↑ | | | | | | | | | | | | | | | | | | | | | | | | | | |
| 6: | 10.3 | ↑ | | | | | | | | | | | | | | | | | | | | | | | | | | |
| 7: | 10.2 | ← | | | | | | | | | | | | | | | | | | | | | | | | | | |
| 8: | 9.7 | ↙ | | | | | | | | | | | | | | | | | | | | | | | | | | |
| 9: | *10.6 | ↘ | | | | | | | | | | | | | | | | | | | | | | | | | | |
| <table style="width:100%; border-collapse: collapse;"> <tr> <td style="width:10%;">Serie</td> <td style="width:80%;"></td> <td style="width:10%; text-align: right;">88.0</td> </tr> <tr> <td>Total</td> <td></td> <td style="text-align: right;">0.0</td> </tr> </table> | | Serie | | 88.0 | Total | | 0.0 | | | | | | | | | | | | | | | | | | | | | |
| Serie | | 88.0 | | | | | | | | | | | | | | | | | | | | | | | | | | |
| Total | | 0.0 | | | | | | | | | | | | | | | | | | | | | | | | | | |

| | | | | | | | | | | | | | | | | | | | | | | | | | | | | | | | |
|--|--|-------|------|------|-------|------|------|----|------|---|----|------|---|----|-------|---|----|-------|---|----|-------|---|----|-----|---|----|------|---|-----|-----|---|
| <p>20 Skud</p> | <table style="width:100%; border-collapse: collapse;"> <tr><td style="width:10%;">1:</td><td style="width:10%;">10.0</td><td style="width:10%; text-align: center;">→</td></tr> <tr><td>2:</td><td>10.5</td><td style="text-align: center;">↑</td></tr> <tr><td>3:</td><td>10.3</td><td style="text-align: center;">→</td></tr> <tr><td>4:</td><td>10.6</td><td style="text-align: center;">↓</td></tr> <tr><td>5:</td><td>*10.7</td><td style="text-align: center;">↗</td></tr> <tr><td>6:</td><td>*10.6</td><td style="text-align: center;">→</td></tr> <tr><td>7:</td><td>*10.7</td><td style="text-align: center;">↑</td></tr> <tr><td>8:</td><td>9.6</td><td style="text-align: center;">↓</td></tr> <tr><td>9:</td><td>10.2</td><td style="text-align: center;">↗</td></tr> <tr><td>10:</td><td>8.8</td><td style="text-align: center;">↙</td></tr> </table> | 1: | 10.0 | → | 2: | 10.5 | ↑ | 3: | 10.3 | → | 4: | 10.6 | ↓ | 5: | *10.7 | ↗ | 6: | *10.6 | → | 7: | *10.7 | ↑ | 8: | 9.6 | ↓ | 9: | 10.2 | ↗ | 10: | 8.8 | ↙ |
| 1: | 10.0 | → | | | | | | | | | | | | | | | | | | | | | | | | | | | | | |
| 2: | 10.5 | ↑ | | | | | | | | | | | | | | | | | | | | | | | | | | | | | |
| 3: | 10.3 | → | | | | | | | | | | | | | | | | | | | | | | | | | | | | | |
| 4: | 10.6 | ↓ | | | | | | | | | | | | | | | | | | | | | | | | | | | | | |
| 5: | *10.7 | ↗ | | | | | | | | | | | | | | | | | | | | | | | | | | | | | |
| 6: | *10.6 | → | | | | | | | | | | | | | | | | | | | | | | | | | | | | | |
| 7: | *10.7 | ↑ | | | | | | | | | | | | | | | | | | | | | | | | | | | | | |
| 8: | 9.6 | ↓ | | | | | | | | | | | | | | | | | | | | | | | | | | | | | |
| 9: | 10.2 | ↗ | | | | | | | | | | | | | | | | | | | | | | | | | | | | | |
| 10: | 8.8 | ↙ | | | | | | | | | | | | | | | | | | | | | | | | | | | | | |
| <table style="width:100%; border-collapse: collapse;"> <tr> <td style="width:10%;">Serie</td> <td style="width:80%;"></td> <td style="width:10%; text-align: right;">97.0</td> </tr> <tr> <td>Total</td> <td></td> <td style="text-align: right;">97.0</td> </tr> </table> | | Serie | | 97.0 | Total | | 97.0 | | | | | | | | | | | | | | | | | | | | | | | | |
| Serie | | 97.0 | | | | | | | | | | | | | | | | | | | | | | | | | | | | | |
| Total | | 97.0 | | | | | | | | | | | | | | | | | | | | | | | | | | | | | |

| | | | | | | | | | | | | | | | | | | | | | | | | | | | | | | | |
|---|---|-------|-----|------|-------|------|-------|-----|-------|---|-----|------|---|-----|------|---|-----|------|---|-----|-----|---|-----|------|---|-----|------|---|-----|------|---|
| <p>20 Skud</p> | <table style="width:100%; border-collapse: collapse;"> <tr><td style="width:10%;">11:</td><td style="width:10%;">9.1</td><td style="width:10%; text-align: center;">↙</td></tr> <tr><td>12:</td><td>10.1</td><td style="text-align: center;">←</td></tr> <tr><td>13:</td><td>*10.9</td><td style="text-align: center;">→</td></tr> <tr><td>14:</td><td>10.1</td><td style="text-align: center;">↘</td></tr> <tr><td>15:</td><td>10.2</td><td style="text-align: center;">←</td></tr> <tr><td>16:</td><td>10.3</td><td style="text-align: center;">↑</td></tr> <tr><td>17:</td><td>8.7</td><td style="text-align: center;">↗</td></tr> <tr><td>18:</td><td>10.4</td><td style="text-align: center;">↗</td></tr> <tr><td>19:</td><td>10.0</td><td style="text-align: center;">↗</td></tr> <tr><td>20:</td><td>10.0</td><td style="text-align: center;">↗</td></tr> </table> | 11: | 9.1 | ↙ | 12: | 10.1 | ← | 13: | *10.9 | → | 14: | 10.1 | ↘ | 15: | 10.2 | ← | 16: | 10.3 | ↑ | 17: | 8.7 | ↗ | 18: | 10.4 | ↗ | 19: | 10.0 | ↗ | 20: | 10.0 | ↗ |
| 11: | 9.1 | ↙ | | | | | | | | | | | | | | | | | | | | | | | | | | | | | |
| 12: | 10.1 | ← | | | | | | | | | | | | | | | | | | | | | | | | | | | | | |
| 13: | *10.9 | → | | | | | | | | | | | | | | | | | | | | | | | | | | | | | |
| 14: | 10.1 | ↘ | | | | | | | | | | | | | | | | | | | | | | | | | | | | | |
| 15: | 10.2 | ← | | | | | | | | | | | | | | | | | | | | | | | | | | | | | |
| 16: | 10.3 | ↑ | | | | | | | | | | | | | | | | | | | | | | | | | | | | | |
| 17: | 8.7 | ↗ | | | | | | | | | | | | | | | | | | | | | | | | | | | | | |
| 18: | 10.4 | ↗ | | | | | | | | | | | | | | | | | | | | | | | | | | | | | |
| 19: | 10.0 | ↗ | | | | | | | | | | | | | | | | | | | | | | | | | | | | | |
| 20: | 10.0 | ↗ | | | | | | | | | | | | | | | | | | | | | | | | | | | | | |
| <table style="width:100%; border-collapse: collapse;"> <tr> <td style="width:10%;">Serie</td> <td style="width:80%;"></td> <td style="width:10%; text-align: right;">97.0</td> </tr> <tr> <td>Total</td> <td></td> <td style="text-align: right;">194.0</td> </tr> </table> | | Serie | | 97.0 | Total | | 194.0 | | | | | | | | | | | | | | | | | | | | | | | | |
| Serie | | 97.0 | | | | | | | | | | | | | | | | | | | | | | | | | | | | | |
| Total | | 194.0 | | | | | | | | | | | | | | | | | | | | | | | | | | | | | |

| | | | | | | | | | | | | | | | | | | | | | | | | | | | | | | | | | | | |
|---------------------|--|----|-----|---|----|-------|---|----|-------|---|----|-------|---|----|-----|---|----|-------|---|----|-------|---|----|-------|---|----|------|---|-----|-------|---|-------|-------|-------|-------|
| <p>Prøve</p> | <table style="width:100%; border-collapse: collapse;"> <tr><td style="text-align: right;">1:</td><td style="text-align: right;">9.8</td><td style="text-align: right;">↗</td></tr> <tr><td style="text-align: right;">2:</td><td style="text-align: right;">*10.8</td><td style="text-align: right;">↑</td></tr> <tr><td style="text-align: right;">3:</td><td style="text-align: right;">*10.6</td><td style="text-align: right;">↗</td></tr> <tr><td style="text-align: right;">4:</td><td style="text-align: right;">*10.6</td><td style="text-align: right;">→</td></tr> <tr><td style="text-align: right;">5:</td><td style="text-align: right;">9.9</td><td style="text-align: right;">→</td></tr> <tr><td style="text-align: right;">6:</td><td style="text-align: right;">*10.7</td><td style="text-align: right;">↘</td></tr> <tr><td style="text-align: right;">7:</td><td style="text-align: right;">*10.8</td><td style="text-align: right;">←</td></tr> <tr><td style="text-align: right;">8:</td><td style="text-align: right;">*10.8</td><td style="text-align: right;">↑</td></tr> <tr><td style="text-align: right;">9:</td><td style="text-align: right;">10.2</td><td style="text-align: right;">↙</td></tr> <tr><td style="text-align: right;">10:</td><td style="text-align: right;">*10.6</td><td style="text-align: right;">↑</td></tr> </table> <table border="1" style="width:100%; border-collapse: collapse; margin-top: 5px;"> <tr> <td style="width:80%;">Serie</td> <td style="text-align: right;">104.8</td> </tr> <tr> <td>Total</td> <td style="text-align: right;">400.0</td> </tr> </table> | 1: | 9.8 | ↗ | 2: | *10.8 | ↑ | 3: | *10.6 | ↗ | 4: | *10.6 | → | 5: | 9.9 | → | 6: | *10.7 | ↘ | 7: | *10.8 | ← | 8: | *10.8 | ↑ | 9: | 10.2 | ↙ | 10: | *10.6 | ↑ | Serie | 104.8 | Total | 400.0 |
| 1: | 9.8 | ↗ | | | | | | | | | | | | | | | | | | | | | | | | | | | | | | | | | |
| 2: | *10.8 | ↑ | | | | | | | | | | | | | | | | | | | | | | | | | | | | | | | | | |
| 3: | *10.6 | ↗ | | | | | | | | | | | | | | | | | | | | | | | | | | | | | | | | | |
| 4: | *10.6 | → | | | | | | | | | | | | | | | | | | | | | | | | | | | | | | | | | |
| 5: | 9.9 | → | | | | | | | | | | | | | | | | | | | | | | | | | | | | | | | | | |
| 6: | *10.7 | ↘ | | | | | | | | | | | | | | | | | | | | | | | | | | | | | | | | | |
| 7: | *10.8 | ← | | | | | | | | | | | | | | | | | | | | | | | | | | | | | | | | | |
| 8: | *10.8 | ↑ | | | | | | | | | | | | | | | | | | | | | | | | | | | | | | | | | |
| 9: | 10.2 | ↙ | | | | | | | | | | | | | | | | | | | | | | | | | | | | | | | | | |
| 10: | *10.6 | ↑ | | | | | | | | | | | | | | | | | | | | | | | | | | | | | | | | | |
| Serie | 104.8 | | | | | | | | | | | | | | | | | | | | | | | | | | | | | | | | | | |
| Total | 400.0 | | | | | | | | | | | | | | | | | | | | | | | | | | | | | | | | | | |

| | | | | | | | | |
|---------------------|--|-----|-------|---|-------|------|-------|-------|
| <p>Prøve</p> | <table style="width:100%; border-collapse: collapse;"> <tr> <td style="text-align: right;">11:</td> <td style="text-align: right;">*10.7</td> <td style="text-align: right;">↓</td> </tr> </table> <table border="1" style="width:100%; border-collapse: collapse; margin-top: 5px;"> <tr> <td style="width:80%;">Serie</td> <td style="text-align: right;">10.7</td> </tr> <tr> <td>Total</td> <td style="text-align: right;">400.0</td> </tr> </table> | 11: | *10.7 | ↓ | Serie | 10.7 | Total | 400.0 |
| 11: | *10.7 | ↓ | | | | | | |
| Serie | 10.7 | | | | | | | |
| Total | 400.0 | | | | | | | |

| | | | | | | | | | | | | | | | | | | | | | | | | | | | | | | | | | | | |
|----------------------|--|----|-------|---|----|------|---|----|-------|---|----|------|---|----|------|---|----|------|---|----|-------|---|----|------|---|----|-------|---|-----|-------|---|-------|-------|-------|-------|
| <p>Finale</p> | <table style="width:100%; border-collapse: collapse;"> <tr><td style="text-align: right;">1:</td><td style="text-align: right;">*10.5</td><td style="text-align: right;">↘</td></tr> <tr><td style="text-align: right;">2:</td><td style="text-align: right;">10.1</td><td style="text-align: right;">↙</td></tr> <tr><td style="text-align: right;">3:</td><td style="text-align: right;">*10.5</td><td style="text-align: right;">↗</td></tr> <tr><td style="text-align: right;">4:</td><td style="text-align: right;">10.2</td><td style="text-align: right;">←</td></tr> <tr><td style="text-align: right;">5:</td><td style="text-align: right;">10.3</td><td style="text-align: right;">↙</td></tr> <tr><td style="text-align: right;">6:</td><td style="text-align: right;">10.1</td><td style="text-align: right;">↑</td></tr> <tr><td style="text-align: right;">7:</td><td style="text-align: right;">*10.6</td><td style="text-align: right;">↗</td></tr> <tr><td style="text-align: right;">8:</td><td style="text-align: right;">10.0</td><td style="text-align: right;">↗</td></tr> <tr><td style="text-align: right;">9:</td><td style="text-align: right;">*10.5</td><td style="text-align: right;">↗</td></tr> <tr><td style="text-align: right;">10:</td><td style="text-align: right;">*10.8</td><td style="text-align: right;">↓</td></tr> </table> <table border="1" style="width:100%; border-collapse: collapse; margin-top: 5px;"> <tr> <td style="width:80%;">Serie</td> <td style="text-align: right;">103.6</td> </tr> <tr> <td>Total</td> <td style="text-align: right;">503.6</td> </tr> </table> | 1: | *10.5 | ↘ | 2: | 10.1 | ↙ | 3: | *10.5 | ↗ | 4: | 10.2 | ← | 5: | 10.3 | ↙ | 6: | 10.1 | ↑ | 7: | *10.6 | ↗ | 8: | 10.0 | ↗ | 9: | *10.5 | ↗ | 10: | *10.8 | ↓ | Serie | 103.6 | Total | 503.6 |
| 1: | *10.5 | ↘ | | | | | | | | | | | | | | | | | | | | | | | | | | | | | | | | | |
| 2: | 10.1 | ↙ | | | | | | | | | | | | | | | | | | | | | | | | | | | | | | | | | |
| 3: | *10.5 | ↗ | | | | | | | | | | | | | | | | | | | | | | | | | | | | | | | | | |
| 4: | 10.2 | ← | | | | | | | | | | | | | | | | | | | | | | | | | | | | | | | | | |
| 5: | 10.3 | ↙ | | | | | | | | | | | | | | | | | | | | | | | | | | | | | | | | | |
| 6: | 10.1 | ↑ | | | | | | | | | | | | | | | | | | | | | | | | | | | | | | | | | |
| 7: | *10.6 | ↗ | | | | | | | | | | | | | | | | | | | | | | | | | | | | | | | | | |
| 8: | 10.0 | ↗ | | | | | | | | | | | | | | | | | | | | | | | | | | | | | | | | | |
| 9: | *10.5 | ↗ | | | | | | | | | | | | | | | | | | | | | | | | | | | | | | | | | |
| 10: | *10.8 | ↓ | | | | | | | | | | | | | | | | | | | | | | | | | | | | | | | | | |
| Serie | 103.6 | | | | | | | | | | | | | | | | | | | | | | | | | | | | | | | | | | |
| Total | 503.6 | | | | | | | | | | | | | | | | | | | | | | | | | | | | | | | | | | |

| | | | | | | | | | | | | | | | | | | | | | | | | | | | | | | | | | | | |
|---------------------|---|----|-----|---|----|-------|---|----|------|---|----|-------|---|----|------|---|----|------|---|----|------|---|----|-------|---|----|------|---|-----|------|---|-------|-------|-------|-------|
| <p>Prøve</p> | <table style="width:100%; border-collapse: collapse;"> <tr><td style="text-align: right;">1:</td><td style="text-align: right;">9.9</td><td style="text-align: right;">→</td></tr> <tr><td style="text-align: right;">2:</td><td style="text-align: right;">*10.6</td><td style="text-align: right;">↑</td></tr> <tr><td style="text-align: right;">3:</td><td style="text-align: right;">10.4</td><td style="text-align: right;">↗</td></tr> <tr><td style="text-align: right;">4:</td><td style="text-align: right;">*10.6</td><td style="text-align: right;">↘</td></tr> <tr><td style="text-align: right;">5:</td><td style="text-align: right;">10.2</td><td style="text-align: right;">→</td></tr> <tr><td style="text-align: right;">6:</td><td style="text-align: right;">10.2</td><td style="text-align: right;">↗</td></tr> <tr><td style="text-align: right;">7:</td><td style="text-align: right;">10.5</td><td style="text-align: right;">↘</td></tr> <tr><td style="text-align: right;">8:</td><td style="text-align: right;">*10.6</td><td style="text-align: right;">→</td></tr> <tr><td style="text-align: right;">9:</td><td style="text-align: right;">10.2</td><td style="text-align: right;">→</td></tr> <tr><td style="text-align: right;">10:</td><td style="text-align: right;">10.4</td><td style="text-align: right;">↗</td></tr> </table> <table border="1" style="width:100%; border-collapse: collapse; margin-top: 5px;"> <tr> <td style="width:80%;">Serie</td> <td style="text-align: right;">103.6</td> </tr> <tr> <td>Total</td> <td style="text-align: right;">400.0</td> </tr> </table> | 1: | 9.9 | → | 2: | *10.6 | ↑ | 3: | 10.4 | ↗ | 4: | *10.6 | ↘ | 5: | 10.2 | → | 6: | 10.2 | ↗ | 7: | 10.5 | ↘ | 8: | *10.6 | → | 9: | 10.2 | → | 10: | 10.4 | ↗ | Serie | 103.6 | Total | 400.0 |
| 1: | 9.9 | → | | | | | | | | | | | | | | | | | | | | | | | | | | | | | | | | | |
| 2: | *10.6 | ↑ | | | | | | | | | | | | | | | | | | | | | | | | | | | | | | | | | |
| 3: | 10.4 | ↗ | | | | | | | | | | | | | | | | | | | | | | | | | | | | | | | | | |
| 4: | *10.6 | ↘ | | | | | | | | | | | | | | | | | | | | | | | | | | | | | | | | | |
| 5: | 10.2 | → | | | | | | | | | | | | | | | | | | | | | | | | | | | | | | | | | |
| 6: | 10.2 | ↗ | | | | | | | | | | | | | | | | | | | | | | | | | | | | | | | | | |
| 7: | 10.5 | ↘ | | | | | | | | | | | | | | | | | | | | | | | | | | | | | | | | | |
| 8: | *10.6 | → | | | | | | | | | | | | | | | | | | | | | | | | | | | | | | | | | |
| 9: | 10.2 | → | | | | | | | | | | | | | | | | | | | | | | | | | | | | | | | | | |
| 10: | 10.4 | ↗ | | | | | | | | | | | | | | | | | | | | | | | | | | | | | | | | | |
| Serie | 103.6 | | | | | | | | | | | | | | | | | | | | | | | | | | | | | | | | | | |
| Total | 400.0 | | | | | | | | | | | | | | | | | | | | | | | | | | | | | | | | | | |

| | | | | | | | | | | | | | | |
|---------------------|---|-----|-------|---|-----|------|---|-----|-------|---|-------|------|-------|-------|
| <p>Prøve</p> | <table style="width:100%; border-collapse: collapse;"> <tr><td style="text-align: right;">11:</td><td style="text-align: right;">*10.8</td><td style="text-align: right;">→</td></tr> <tr><td style="text-align: right;">12:</td><td style="text-align: right;">10.4</td><td style="text-align: right;">↗</td></tr> <tr><td style="text-align: right;">13:</td><td style="text-align: right;">*10.7</td><td style="text-align: right;">↓</td></tr> </table> <table border="1" style="width:100%; border-collapse: collapse; margin-top: 5px;"> <tr> <td style="width:80%;">Serie</td> <td style="text-align: right;">31.9</td> </tr> <tr> <td>Total</td> <td style="text-align: right;">400.0</td> </tr> </table> | 11: | *10.8 | → | 12: | 10.4 | ↗ | 13: | *10.7 | ↓ | Serie | 31.9 | Total | 400.0 |
| 11: | *10.8 | → | | | | | | | | | | | | |
| 12: | 10.4 | ↗ | | | | | | | | | | | | |
| 13: | *10.7 | ↓ | | | | | | | | | | | | |
| Serie | 31.9 | | | | | | | | | | | | | |
| Total | 400.0 | | | | | | | | | | | | | |

| | | | | | | | | | | | | | | | | | | | | | | | | | | | | | | | | | | | |
|----------------------|---|----|-------|---|----|------|---|----|------|---|----|-------|---|----|-------|---|----|-------|---|----|-------|---|----|-------|---|----|-------|---|-----|-------|---|-------|-------|-------|-------|
| <p>Finale</p> | <table style="width:100%; border-collapse: collapse;"> <tr><td style="text-align: right;">1:</td><td style="text-align: right;">*10.7</td><td style="text-align: right;">↗</td></tr> <tr><td style="text-align: right;">2:</td><td style="text-align: right;">10.4</td><td style="text-align: right;">→</td></tr> <tr><td style="text-align: right;">3:</td><td style="text-align: right;">10.0</td><td style="text-align: right;">↗</td></tr> <tr><td style="text-align: right;">4:</td><td style="text-align: right;">*10.7</td><td style="text-align: right;">↗</td></tr> <tr><td style="text-align: right;">5:</td><td style="text-align: right;">*10.7</td><td style="text-align: right;">↘</td></tr> <tr><td style="text-align: right;">6:</td><td style="text-align: right;">*10.6</td><td style="text-align: right;">↘</td></tr> <tr><td style="text-align: right;">7:</td><td style="text-align: right;">*10.6</td><td style="text-align: right;">↗</td></tr> <tr><td style="text-align: right;">8:</td><td style="text-align: right;">*10.7</td><td style="text-align: right;">↘</td></tr> <tr><td style="text-align: right;">9:</td><td style="text-align: right;">*10.6</td><td style="text-align: right;">↘</td></tr> <tr><td style="text-align: right;">10:</td><td style="text-align: right;">*10.6</td><td style="text-align: right;">←</td></tr> </table> <table border="1" style="width:100%; border-collapse: collapse; margin-top: 5px;"> <tr> <td style="width:80%;">Serie</td> <td style="text-align: right;">105.6</td> </tr> <tr> <td>Total</td> <td style="text-align: right;">505.6</td> </tr> </table> | 1: | *10.7 | ↗ | 2: | 10.4 | → | 3: | 10.0 | ↗ | 4: | *10.7 | ↗ | 5: | *10.7 | ↘ | 6: | *10.6 | ↘ | 7: | *10.6 | ↗ | 8: | *10.7 | ↘ | 9: | *10.6 | ↘ | 10: | *10.6 | ← | Serie | 105.6 | Total | 505.6 |
| 1: | *10.7 | ↗ | | | | | | | | | | | | | | | | | | | | | | | | | | | | | | | | | |
| 2: | 10.4 | → | | | | | | | | | | | | | | | | | | | | | | | | | | | | | | | | | |
| 3: | 10.0 | ↗ | | | | | | | | | | | | | | | | | | | | | | | | | | | | | | | | | |
| 4: | *10.7 | ↗ | | | | | | | | | | | | | | | | | | | | | | | | | | | | | | | | | |
| 5: | *10.7 | ↘ | | | | | | | | | | | | | | | | | | | | | | | | | | | | | | | | | |
| 6: | *10.6 | ↘ | | | | | | | | | | | | | | | | | | | | | | | | | | | | | | | | | |
| 7: | *10.6 | ↗ | | | | | | | | | | | | | | | | | | | | | | | | | | | | | | | | | |
| 8: | *10.7 | ↘ | | | | | | | | | | | | | | | | | | | | | | | | | | | | | | | | | |
| 9: | *10.6 | ↘ | | | | | | | | | | | | | | | | | | | | | | | | | | | | | | | | | |
| 10: | *10.6 | ← | | | | | | | | | | | | | | | | | | | | | | | | | | | | | | | | | |
| Serie | 105.6 | | | | | | | | | | | | | | | | | | | | | | | | | | | | | | | | | | |
| Total | 505.6 | | | | | | | | | | | | | | | | | | | | | | | | | | | | | | | | | | |

| | | | | | | | | | | | | | | | | | | | | | | | | | | | | | | | | | | | | | |
|---------------------|--|--------------|-----|---|----|-----|---|----|-------|---|----|------|---|----|------|---|----|------|---|----|-------|---|----|-------|---|----|-------|---|-----|-------|---|--------------|--|--------------|--------------|--|--------------|
| <p>Prøve</p> | <table style="width:100%; border-collapse: collapse;"> <tr><td style="width:10%;">1:</td><td style="width:20%;">9.9</td><td style="width:10%; text-align: right;">↓</td></tr> <tr><td>2:</td><td>9.9</td><td style="text-align: right;">↑</td></tr> <tr><td>3:</td><td>*10.7</td><td style="text-align: right;">←</td></tr> <tr><td>4:</td><td>10.2</td><td style="text-align: right;">↑</td></tr> <tr><td>5:</td><td>10.1</td><td style="text-align: right;">↗</td></tr> <tr><td>6:</td><td>10.2</td><td style="text-align: right;">↗</td></tr> <tr><td>7:</td><td>*10.7</td><td style="text-align: right;">←</td></tr> <tr><td>8:</td><td>*10.6</td><td style="text-align: right;">↗</td></tr> <tr><td>9:</td><td>*10.6</td><td style="text-align: right;">↗</td></tr> <tr><td>10:</td><td>*10.7</td><td style="text-align: right;">↗</td></tr> <tr><td colspan="2">Serie</td><td style="text-align: right;">103.6</td></tr> <tr><td colspan="2">Total</td><td style="text-align: right;">400.0</td></tr> </table> | 1: | 9.9 | ↓ | 2: | 9.9 | ↑ | 3: | *10.7 | ← | 4: | 10.2 | ↑ | 5: | 10.1 | ↗ | 6: | 10.2 | ↗ | 7: | *10.7 | ← | 8: | *10.6 | ↗ | 9: | *10.6 | ↗ | 10: | *10.7 | ↗ | Serie | | 103.6 | Total | | 400.0 |
| 1: | 9.9 | ↓ | | | | | | | | | | | | | | | | | | | | | | | | | | | | | | | | | | | |
| 2: | 9.9 | ↑ | | | | | | | | | | | | | | | | | | | | | | | | | | | | | | | | | | | |
| 3: | *10.7 | ← | | | | | | | | | | | | | | | | | | | | | | | | | | | | | | | | | | | |
| 4: | 10.2 | ↑ | | | | | | | | | | | | | | | | | | | | | | | | | | | | | | | | | | | |
| 5: | 10.1 | ↗ | | | | | | | | | | | | | | | | | | | | | | | | | | | | | | | | | | | |
| 6: | 10.2 | ↗ | | | | | | | | | | | | | | | | | | | | | | | | | | | | | | | | | | | |
| 7: | *10.7 | ← | | | | | | | | | | | | | | | | | | | | | | | | | | | | | | | | | | | |
| 8: | *10.6 | ↗ | | | | | | | | | | | | | | | | | | | | | | | | | | | | | | | | | | | |
| 9: | *10.6 | ↗ | | | | | | | | | | | | | | | | | | | | | | | | | | | | | | | | | | | |
| 10: | *10.7 | ↗ | | | | | | | | | | | | | | | | | | | | | | | | | | | | | | | | | | | |
| Serie | | 103.6 | | | | | | | | | | | | | | | | | | | | | | | | | | | | | | | | | | | |
| Total | | 400.0 | | | | | | | | | | | | | | | | | | | | | | | | | | | | | | | | | | | |

| | | | | | | | | | | | | | | | | | | | |
|---------------------|--|--------------|-------|---|-----|------|---|-----|-------|---|-----|-------|---|--------------|--|-------------|--------------|--|--------------|
| <p>Prøve</p> | <table style="width:100%; border-collapse: collapse;"> <tr><td style="width:10%;">11:</td><td style="width:20%;">*10.6</td><td style="width:10%; text-align: right;">↑</td></tr> <tr><td>12:</td><td>10.0</td><td style="text-align: right;">↓</td></tr> <tr><td>13:</td><td>*10.6</td><td style="text-align: right;">↗</td></tr> <tr><td>14:</td><td>*10.8</td><td style="text-align: right;">↑</td></tr> <tr><td colspan="2">Serie</td><td style="text-align: right;">42.0</td></tr> <tr><td colspan="2">Total</td><td style="text-align: right;">400.0</td></tr> </table> | 11: | *10.6 | ↑ | 12: | 10.0 | ↓ | 13: | *10.6 | ↗ | 14: | *10.8 | ↑ | Serie | | 42.0 | Total | | 400.0 |
| 11: | *10.6 | ↑ | | | | | | | | | | | | | | | | | |
| 12: | 10.0 | ↓ | | | | | | | | | | | | | | | | | |
| 13: | *10.6 | ↗ | | | | | | | | | | | | | | | | | |
| 14: | *10.8 | ↑ | | | | | | | | | | | | | | | | | |
| Serie | | 42.0 | | | | | | | | | | | | | | | | | |
| Total | | 400.0 | | | | | | | | | | | | | | | | | |

| | | | | | | | | | | | | | | | | | | | | | | | | | | | | | | | | | | | | | |
|----------------------|---|--------------|-------|---|----|-------|---|----|-------|---|----|------|---|----|-------|---|----|------|---|----|-------|---|----|-------|---|----|------|---|-----|------|---|--------------|--|--------------|--------------|--|--------------|
| <p>Finale</p> | <table style="width:100%; border-collapse: collapse;"> <tr><td style="width:10%;">1:</td><td style="width:20%;">*10.6</td><td style="width:10%; text-align: right;">↗</td></tr> <tr><td>2:</td><td>*10.6</td><td style="text-align: right;">↗</td></tr> <tr><td>3:</td><td>*10.8</td><td style="text-align: right;">↗</td></tr> <tr><td>4:</td><td>10.4</td><td style="text-align: right;">↓</td></tr> <tr><td>5:</td><td>*10.9</td><td style="text-align: right;">↓</td></tr> <tr><td>6:</td><td>10.4</td><td style="text-align: right;">↗</td></tr> <tr><td>7:</td><td>*10.8</td><td style="text-align: right;">↑</td></tr> <tr><td>8:</td><td>*10.8</td><td style="text-align: right;">↑</td></tr> <tr><td>9:</td><td>10.5</td><td style="text-align: right;">↗</td></tr> <tr><td>10:</td><td>10.4</td><td style="text-align: right;">←</td></tr> <tr><td colspan="2">Serie</td><td style="text-align: right;">106.2</td></tr> <tr><td colspan="2">Total</td><td style="text-align: right;">506.2</td></tr> </table> | 1: | *10.6 | ↗ | 2: | *10.6 | ↗ | 3: | *10.8 | ↗ | 4: | 10.4 | ↓ | 5: | *10.9 | ↓ | 6: | 10.4 | ↗ | 7: | *10.8 | ↑ | 8: | *10.8 | ↑ | 9: | 10.5 | ↗ | 10: | 10.4 | ← | Serie | | 106.2 | Total | | 506.2 |
| 1: | *10.6 | ↗ | | | | | | | | | | | | | | | | | | | | | | | | | | | | | | | | | | | |
| 2: | *10.6 | ↗ | | | | | | | | | | | | | | | | | | | | | | | | | | | | | | | | | | | |
| 3: | *10.8 | ↗ | | | | | | | | | | | | | | | | | | | | | | | | | | | | | | | | | | | |
| 4: | 10.4 | ↓ | | | | | | | | | | | | | | | | | | | | | | | | | | | | | | | | | | | |
| 5: | *10.9 | ↓ | | | | | | | | | | | | | | | | | | | | | | | | | | | | | | | | | | | |
| 6: | 10.4 | ↗ | | | | | | | | | | | | | | | | | | | | | | | | | | | | | | | | | | | |
| 7: | *10.8 | ↑ | | | | | | | | | | | | | | | | | | | | | | | | | | | | | | | | | | | |
| 8: | *10.8 | ↑ | | | | | | | | | | | | | | | | | | | | | | | | | | | | | | | | | | | |
| 9: | 10.5 | ↗ | | | | | | | | | | | | | | | | | | | | | | | | | | | | | | | | | | | |
| 10: | 10.4 | ← | | | | | | | | | | | | | | | | | | | | | | | | | | | | | | | | | | | |
| Serie | | 106.2 | | | | | | | | | | | | | | | | | | | | | | | | | | | | | | | | | | | |
| Total | | 506.2 | | | | | | | | | | | | | | | | | | | | | | | | | | | | | | | | | | | |

| | | | | | | | | | | | | | | | | | | | | | | | | | | | | | | | |
|--|--|-------|-------|-------|-------|-----|---|----|------|---|----|------|---|----|------|---|----|------|---|----|-------|---|----|------|---|----|------|---|-----|-------|---|
| <p>Prøve</p> | <table style="width:100%; border-collapse: collapse;"> <tr><td>1:</td><td>9.5</td><td style="text-align: center;">↑</td></tr> <tr><td>2:</td><td>9.3</td><td style="text-align: center;">↑</td></tr> <tr><td>3:</td><td>10.2</td><td style="text-align: center;">→</td></tr> <tr><td>4:</td><td>10.1</td><td style="text-align: center;">↗</td></tr> <tr><td>5:</td><td>10.2</td><td style="text-align: center;">↗</td></tr> <tr><td>6:</td><td>10.0</td><td style="text-align: center;">↑</td></tr> <tr><td>7:</td><td>*10.6</td><td style="text-align: center;">↗</td></tr> <tr><td>8:</td><td>10.1</td><td style="text-align: center;">↓</td></tr> <tr><td>9:</td><td>10.4</td><td style="text-align: center;">↙</td></tr> <tr><td>10:</td><td>*10.5</td><td style="text-align: center;">↗</td></tr> </table> | 1: | 9.5 | ↑ | 2: | 9.3 | ↑ | 3: | 10.2 | → | 4: | 10.1 | ↗ | 5: | 10.2 | ↗ | 6: | 10.0 | ↑ | 7: | *10.6 | ↗ | 8: | 10.1 | ↓ | 9: | 10.4 | ↙ | 10: | *10.5 | ↗ |
| 1: | 9.5 | ↑ | | | | | | | | | | | | | | | | | | | | | | | | | | | | | |
| 2: | 9.3 | ↑ | | | | | | | | | | | | | | | | | | | | | | | | | | | | | |
| 3: | 10.2 | → | | | | | | | | | | | | | | | | | | | | | | | | | | | | | |
| 4: | 10.1 | ↗ | | | | | | | | | | | | | | | | | | | | | | | | | | | | | |
| 5: | 10.2 | ↗ | | | | | | | | | | | | | | | | | | | | | | | | | | | | | |
| 6: | 10.0 | ↑ | | | | | | | | | | | | | | | | | | | | | | | | | | | | | |
| 7: | *10.6 | ↗ | | | | | | | | | | | | | | | | | | | | | | | | | | | | | |
| 8: | 10.1 | ↓ | | | | | | | | | | | | | | | | | | | | | | | | | | | | | |
| 9: | 10.4 | ↙ | | | | | | | | | | | | | | | | | | | | | | | | | | | | | |
| 10: | *10.5 | ↗ | | | | | | | | | | | | | | | | | | | | | | | | | | | | | |
| <table style="width:100%; border-collapse: collapse;"> <tr> <td style="width:80%;">Serie</td> <td style="text-align: right;">100.9</td> </tr> <tr> <td>Total</td> <td style="text-align: right;">399.0</td> </tr> </table> | | Serie | 100.9 | Total | 399.0 | | | | | | | | | | | | | | | | | | | | | | | | | | |
| Serie | 100.9 | | | | | | | | | | | | | | | | | | | | | | | | | | | | | | |
| Total | 399.0 | | | | | | | | | | | | | | | | | | | | | | | | | | | | | | |

| | | | | | | | | | | |
|---|--|-------|------|-------|-------|-------|---|-----|-------|---|
| <p>Prøve</p> | <table style="width:100%; border-collapse: collapse;"> <tr><td>11:</td><td>10.3</td><td style="text-align: center;">↘</td></tr> <tr><td>12:</td><td>*10.5</td><td style="text-align: center;">↗</td></tr> <tr><td>13:</td><td>*10.6</td><td style="text-align: center;">↗</td></tr> </table> | 11: | 10.3 | ↘ | 12: | *10.5 | ↗ | 13: | *10.6 | ↗ |
| 11: | 10.3 | ↘ | | | | | | | | |
| 12: | *10.5 | ↗ | | | | | | | | |
| 13: | *10.6 | ↗ | | | | | | | | |
| <table style="width:100%; border-collapse: collapse;"> <tr> <td style="width:80%;">Serie</td> <td style="text-align: right;">31.4</td> </tr> <tr> <td>Total</td> <td style="text-align: right;">399.0</td> </tr> </table> | | Serie | 31.4 | Total | 399.0 | | | | | |
| Serie | 31.4 | | | | | | | | | |
| Total | 399.0 | | | | | | | | | |

| | | | | | | | | | | | | | | | | | | | | | | | | | | | | | | | |
|--|---|-------|-------|-------|-------|-------|---|----|------|---|----|-------|---|----|-------|---|----|-------|---|----|------|---|----|-------|---|----|------|---|-----|-------|---|
| <p>Finale</p> | <table style="width:100%; border-collapse: collapse;"> <tr><td>1:</td><td>*10.7</td><td style="text-align: center;">←</td></tr> <tr><td>2:</td><td>*10.6</td><td style="text-align: center;">↓</td></tr> <tr><td>3:</td><td>10.4</td><td style="text-align: center;">↙</td></tr> <tr><td>4:</td><td>*10.8</td><td style="text-align: center;">↙</td></tr> <tr><td>5:</td><td>*10.8</td><td style="text-align: center;">↗</td></tr> <tr><td>6:</td><td>*10.5</td><td style="text-align: center;">↓</td></tr> <tr><td>7:</td><td>10.4</td><td style="text-align: center;">→</td></tr> <tr><td>8:</td><td>*10.7</td><td style="text-align: center;">↗</td></tr> <tr><td>9:</td><td>10.3</td><td style="text-align: center;">←</td></tr> <tr><td>10:</td><td>*10.6</td><td style="text-align: center;">↘</td></tr> </table> | 1: | *10.7 | ← | 2: | *10.6 | ↓ | 3: | 10.4 | ↙ | 4: | *10.8 | ↙ | 5: | *10.8 | ↗ | 6: | *10.5 | ↓ | 7: | 10.4 | → | 8: | *10.7 | ↗ | 9: | 10.3 | ← | 10: | *10.6 | ↘ |
| 1: | *10.7 | ← | | | | | | | | | | | | | | | | | | | | | | | | | | | | | |
| 2: | *10.6 | ↓ | | | | | | | | | | | | | | | | | | | | | | | | | | | | | |
| 3: | 10.4 | ↙ | | | | | | | | | | | | | | | | | | | | | | | | | | | | | |
| 4: | *10.8 | ↙ | | | | | | | | | | | | | | | | | | | | | | | | | | | | | |
| 5: | *10.8 | ↗ | | | | | | | | | | | | | | | | | | | | | | | | | | | | | |
| 6: | *10.5 | ↓ | | | | | | | | | | | | | | | | | | | | | | | | | | | | | |
| 7: | 10.4 | → | | | | | | | | | | | | | | | | | | | | | | | | | | | | | |
| 8: | *10.7 | ↗ | | | | | | | | | | | | | | | | | | | | | | | | | | | | | |
| 9: | 10.3 | ← | | | | | | | | | | | | | | | | | | | | | | | | | | | | | |
| 10: | *10.6 | ↘ | | | | | | | | | | | | | | | | | | | | | | | | | | | | | |
| <table style="width:100%; border-collapse: collapse;"> <tr> <td style="width:80%;">Serie</td> <td style="text-align: right;">105.8</td> </tr> <tr> <td>Total</td> <td style="text-align: right;">504.8</td> </tr> </table> | | Serie | 105.8 | Total | 504.8 | | | | | | | | | | | | | | | | | | | | | | | | | | |
| Serie | 105.8 | | | | | | | | | | | | | | | | | | | | | | | | | | | | | | |
| Total | 504.8 | | | | | | | | | | | | | | | | | | | | | | | | | | | | | | |

| | | | | | | | | | | | | | | | | | | | | | | | | | | | | | | | | | | | |
|---------------------|--|----|------|---|----|-----|---|----|------|---|----|-------|---|----|------|---|----|------|---|----|------|---|----|-------|---|----|------|---|-----|------|---|-------|-------|-------|-------|
| <p>Prøve</p> | <table style="width:100%; border-collapse: collapse;"> <tr><td style="text-align: right;">1:</td><td style="text-align: right;">10.3</td><td style="text-align: right;">↓</td></tr> <tr><td style="text-align: right;">2:</td><td style="text-align: right;">9.9</td><td style="text-align: right;">↙</td></tr> <tr><td style="text-align: right;">3:</td><td style="text-align: right;">10.4</td><td style="text-align: right;">↙</td></tr> <tr><td style="text-align: right;">4:</td><td style="text-align: right;">*10.8</td><td style="text-align: right;">↖</td></tr> <tr><td style="text-align: right;">5:</td><td style="text-align: right;">10.3</td><td style="text-align: right;">↑</td></tr> <tr><td style="text-align: right;">6:</td><td style="text-align: right;">10.4</td><td style="text-align: right;">←</td></tr> <tr><td style="text-align: right;">7:</td><td style="text-align: right;">10.3</td><td style="text-align: right;">↗</td></tr> <tr><td style="text-align: right;">8:</td><td style="text-align: right;">*10.8</td><td style="text-align: right;">↓</td></tr> <tr><td style="text-align: right;">9:</td><td style="text-align: right;">10.4</td><td style="text-align: right;">↑</td></tr> <tr><td style="text-align: right;">10:</td><td style="text-align: right;">10.3</td><td style="text-align: right;">↗</td></tr> </table> <table border="1" style="width:100%; border-collapse: collapse; margin-top: 5px;"> <tr> <td style="width:80%;">Serie</td> <td style="text-align: right;">103.9</td> </tr> <tr> <td>Total</td> <td style="text-align: right;">399.0</td> </tr> </table> | 1: | 10.3 | ↓ | 2: | 9.9 | ↙ | 3: | 10.4 | ↙ | 4: | *10.8 | ↖ | 5: | 10.3 | ↑ | 6: | 10.4 | ← | 7: | 10.3 | ↗ | 8: | *10.8 | ↓ | 9: | 10.4 | ↑ | 10: | 10.3 | ↗ | Serie | 103.9 | Total | 399.0 |
| 1: | 10.3 | ↓ | | | | | | | | | | | | | | | | | | | | | | | | | | | | | | | | | |
| 2: | 9.9 | ↙ | | | | | | | | | | | | | | | | | | | | | | | | | | | | | | | | | |
| 3: | 10.4 | ↙ | | | | | | | | | | | | | | | | | | | | | | | | | | | | | | | | | |
| 4: | *10.8 | ↖ | | | | | | | | | | | | | | | | | | | | | | | | | | | | | | | | | |
| 5: | 10.3 | ↑ | | | | | | | | | | | | | | | | | | | | | | | | | | | | | | | | | |
| 6: | 10.4 | ← | | | | | | | | | | | | | | | | | | | | | | | | | | | | | | | | | |
| 7: | 10.3 | ↗ | | | | | | | | | | | | | | | | | | | | | | | | | | | | | | | | | |
| 8: | *10.8 | ↓ | | | | | | | | | | | | | | | | | | | | | | | | | | | | | | | | | |
| 9: | 10.4 | ↑ | | | | | | | | | | | | | | | | | | | | | | | | | | | | | | | | | |
| 10: | 10.3 | ↗ | | | | | | | | | | | | | | | | | | | | | | | | | | | | | | | | | |
| Serie | 103.9 | | | | | | | | | | | | | | | | | | | | | | | | | | | | | | | | | | |
| Total | 399.0 | | | | | | | | | | | | | | | | | | | | | | | | | | | | | | | | | | |

| | | | | | | | | |
|---------------------|--|-----|-------|---|-------|------|-------|-------|
| <p>Prøve</p> | <table style="width:100%; border-collapse: collapse;"> <tr> <td style="text-align: right;">11:</td> <td style="text-align: right;">*10.6</td> <td style="text-align: right;">↗</td> </tr> </table> <table border="1" style="width:100%; border-collapse: collapse; margin-top: 5px;"> <tr> <td style="width:80%;">Serie</td> <td style="text-align: right;">10.6</td> </tr> <tr> <td>Total</td> <td style="text-align: right;">399.0</td> </tr> </table> | 11: | *10.6 | ↗ | Serie | 10.6 | Total | 399.0 |
| 11: | *10.6 | ↗ | | | | | | |
| Serie | 10.6 | | | | | | | |
| Total | 399.0 | | | | | | | |

| | | | | | | | | | | | | | | | | | | | | | | | | | | | | | | | | | | | |
|----------------------|---|----|-------|---|----|------|---|----|------|---|----|-------|---|----|-------|---|----|------|---|----|------|---|----|------|---|----|------|---|-----|-------|---|-------|-------|-------|-------|
| <p>Finale</p> | <table style="width:100%; border-collapse: collapse;"> <tr><td style="text-align: right;">1:</td><td style="text-align: right;">*10.5</td><td style="text-align: right;">↑</td></tr> <tr><td style="text-align: right;">2:</td><td style="text-align: right;">10.4</td><td style="text-align: right;">→</td></tr> <tr><td style="text-align: right;">3:</td><td style="text-align: right;">10.3</td><td style="text-align: right;">→</td></tr> <tr><td style="text-align: right;">4:</td><td style="text-align: right;">*10.5</td><td style="text-align: right;">←</td></tr> <tr><td style="text-align: right;">5:</td><td style="text-align: right;">*10.7</td><td style="text-align: right;">↗</td></tr> <tr><td style="text-align: right;">6:</td><td style="text-align: right;">10.3</td><td style="text-align: right;">↗</td></tr> <tr><td style="text-align: right;">7:</td><td style="text-align: right;">10.3</td><td style="text-align: right;">↗</td></tr> <tr><td style="text-align: right;">8:</td><td style="text-align: right;">10.0</td><td style="text-align: right;">↑</td></tr> <tr><td style="text-align: right;">9:</td><td style="text-align: right;">10.2</td><td style="text-align: right;">↓</td></tr> <tr><td style="text-align: right;">10:</td><td style="text-align: right;">*10.6</td><td style="text-align: right;">↑</td></tr> </table> <table border="1" style="width:100%; border-collapse: collapse; margin-top: 5px;"> <tr> <td style="width:80%;">Serie</td> <td style="text-align: right;">103.8</td> </tr> <tr> <td>Total</td> <td style="text-align: right;">502.8</td> </tr> </table> | 1: | *10.5 | ↑ | 2: | 10.4 | → | 3: | 10.3 | → | 4: | *10.5 | ← | 5: | *10.7 | ↗ | 6: | 10.3 | ↗ | 7: | 10.3 | ↗ | 8: | 10.0 | ↑ | 9: | 10.2 | ↓ | 10: | *10.6 | ↑ | Serie | 103.8 | Total | 502.8 |
| 1: | *10.5 | ↑ | | | | | | | | | | | | | | | | | | | | | | | | | | | | | | | | | |
| 2: | 10.4 | → | | | | | | | | | | | | | | | | | | | | | | | | | | | | | | | | | |
| 3: | 10.3 | → | | | | | | | | | | | | | | | | | | | | | | | | | | | | | | | | | |
| 4: | *10.5 | ← | | | | | | | | | | | | | | | | | | | | | | | | | | | | | | | | | |
| 5: | *10.7 | ↗ | | | | | | | | | | | | | | | | | | | | | | | | | | | | | | | | | |
| 6: | 10.3 | ↗ | | | | | | | | | | | | | | | | | | | | | | | | | | | | | | | | | |
| 7: | 10.3 | ↗ | | | | | | | | | | | | | | | | | | | | | | | | | | | | | | | | | |
| 8: | 10.0 | ↑ | | | | | | | | | | | | | | | | | | | | | | | | | | | | | | | | | |
| 9: | 10.2 | ↓ | | | | | | | | | | | | | | | | | | | | | | | | | | | | | | | | | |
| 10: | *10.6 | ↑ | | | | | | | | | | | | | | | | | | | | | | | | | | | | | | | | | |
| Serie | 103.8 | | | | | | | | | | | | | | | | | | | | | | | | | | | | | | | | | | |
| Total | 502.8 | | | | | | | | | | | | | | | | | | | | | | | | | | | | | | | | | | |

| | | | | | | | | | | | | | | | | | | | | | | | | | | | | | | | | | | | | | | | | | | | | | |
|---------------------|--|----|------|--|---|----|------|--|---|----|------|--|---|----|-------|--|---|----|------|--|---|----|------|--|---|----|------|--|---|----|-------|--|---|----|------|--|---|-----|-------|--|---|-------|-------|-------|-------|
| <p>Prøve</p> | <table style="width:100%; border-collapse: collapse;"> <tr><td style="width:5%;">1:</td><td style="width:15%;">10.4</td><td style="width:10%;"></td><td style="width:10%; text-align: center;">↘</td></tr> <tr><td>2:</td><td>10.4</td><td></td><td style="text-align: center;">↘</td></tr> <tr><td>3:</td><td>10.3</td><td></td><td style="text-align: center;">↘</td></tr> <tr><td>4:</td><td>*10.9</td><td></td><td style="text-align: center;">↘</td></tr> <tr><td>5:</td><td>10.5</td><td></td><td style="text-align: center;">↘</td></tr> <tr><td>6:</td><td>10.4</td><td></td><td style="text-align: center;">↘</td></tr> <tr><td>7:</td><td>10.4</td><td></td><td style="text-align: center;">↑</td></tr> <tr><td>8:</td><td>*10.5</td><td></td><td style="text-align: center;">←</td></tr> <tr><td>9:</td><td>10.3</td><td></td><td style="text-align: center;">↑</td></tr> <tr><td>10:</td><td>*10.8</td><td></td><td style="text-align: center;">↑</td></tr> </table> <table border="1" style="width:100%; border-collapse: collapse; margin-top: 5px;"> <tr> <td style="width:85%;">Serie</td> <td style="width:15%; text-align: right;">104.9</td> </tr> <tr> <td>Total</td> <td style="text-align: right;">399.0</td> </tr> </table> | 1: | 10.4 | | ↘ | 2: | 10.4 | | ↘ | 3: | 10.3 | | ↘ | 4: | *10.9 | | ↘ | 5: | 10.5 | | ↘ | 6: | 10.4 | | ↘ | 7: | 10.4 | | ↑ | 8: | *10.5 | | ← | 9: | 10.3 | | ↑ | 10: | *10.8 | | ↑ | Serie | 104.9 | Total | 399.0 |
| 1: | 10.4 | | ↘ | | | | | | | | | | | | | | | | | | | | | | | | | | | | | | | | | | | | | | | | | | |
| 2: | 10.4 | | ↘ | | | | | | | | | | | | | | | | | | | | | | | | | | | | | | | | | | | | | | | | | | |
| 3: | 10.3 | | ↘ | | | | | | | | | | | | | | | | | | | | | | | | | | | | | | | | | | | | | | | | | | |
| 4: | *10.9 | | ↘ | | | | | | | | | | | | | | | | | | | | | | | | | | | | | | | | | | | | | | | | | | |
| 5: | 10.5 | | ↘ | | | | | | | | | | | | | | | | | | | | | | | | | | | | | | | | | | | | | | | | | | |
| 6: | 10.4 | | ↘ | | | | | | | | | | | | | | | | | | | | | | | | | | | | | | | | | | | | | | | | | | |
| 7: | 10.4 | | ↑ | | | | | | | | | | | | | | | | | | | | | | | | | | | | | | | | | | | | | | | | | | |
| 8: | *10.5 | | ← | | | | | | | | | | | | | | | | | | | | | | | | | | | | | | | | | | | | | | | | | | |
| 9: | 10.3 | | ↑ | | | | | | | | | | | | | | | | | | | | | | | | | | | | | | | | | | | | | | | | | | |
| 10: | *10.8 | | ↑ | | | | | | | | | | | | | | | | | | | | | | | | | | | | | | | | | | | | | | | | | | |
| Serie | 104.9 | | | | | | | | | | | | | | | | | | | | | | | | | | | | | | | | | | | | | | | | | | | | |
| Total | 399.0 | | | | | | | | | | | | | | | | | | | | | | | | | | | | | | | | | | | | | | | | | | | | |

| | | | | | | | | | |
|---------------------|---|-----|-------|--|---|-------|------|-------|-------|
| <p>Prøve</p> | <table style="width:100%; border-collapse: collapse;"> <tr> <td style="width:5%;">11:</td> <td style="width:15%;">*10.8</td> <td style="width:10%;"></td> <td style="width:10%; text-align: center;">↗</td> </tr> </table> <table border="1" style="width:100%; border-collapse: collapse; margin-top: 5px;"> <tr> <td style="width:85%;">Serie</td> <td style="width:15%; text-align: right;">10.8</td> </tr> <tr> <td>Total</td> <td style="text-align: right;">399.0</td> </tr> </table> | 11: | *10.8 | | ↗ | Serie | 10.8 | Total | 399.0 |
| 11: | *10.8 | | ↗ | | | | | | |
| Serie | 10.8 | | | | | | | | |
| Total | 399.0 | | | | | | | | |

| | | | | | | | | | | | | | | | | | | | | | | | | | | | | | | | | | | | | | | | | | | | | | |
|----------------------|--|----|------|--|---|----|-------|--|---|----|-------|--|---|----|-------|--|---|----|-------|--|---|----|-------|--|---|----|-------|--|---|----|-------|--|---|----|------|--|---|-----|------|--|---|-------|-------|-------|-------|
| <p>Finale</p> | <table style="width:100%; border-collapse: collapse;"> <tr><td style="width:5%;">1:</td><td style="width:15%;">10.1</td><td style="width:10%;"></td><td style="width:10%; text-align: center;">←</td></tr> <tr><td>2:</td><td>*10.8</td><td></td><td style="text-align: center;">→</td></tr> <tr><td>3:</td><td>*10.6</td><td></td><td style="text-align: center;">→</td></tr> <tr><td>4:</td><td>*10.6</td><td></td><td style="text-align: center;">←</td></tr> <tr><td>5:</td><td>*10.7</td><td></td><td style="text-align: center;">→</td></tr> <tr><td>6:</td><td>*10.5</td><td></td><td style="text-align: center;">→</td></tr> <tr><td>7:</td><td>*10.6</td><td></td><td style="text-align: center;">↑</td></tr> <tr><td>8:</td><td>*10.8</td><td></td><td style="text-align: center;">↗</td></tr> <tr><td>9:</td><td>10.2</td><td></td><td style="text-align: center;">←</td></tr> <tr><td>10:</td><td>10.5</td><td></td><td style="text-align: center;">←</td></tr> </table> <table border="1" style="width:100%; border-collapse: collapse; margin-top: 5px;"> <tr> <td style="width:85%;">Serie</td> <td style="width:15%; text-align: right;">105.4</td> </tr> <tr> <td>Total</td> <td style="text-align: right;">504.4</td> </tr> </table> | 1: | 10.1 | | ← | 2: | *10.8 | | → | 3: | *10.6 | | → | 4: | *10.6 | | ← | 5: | *10.7 | | → | 6: | *10.5 | | → | 7: | *10.6 | | ↑ | 8: | *10.8 | | ↗ | 9: | 10.2 | | ← | 10: | 10.5 | | ← | Serie | 105.4 | Total | 504.4 |
| 1: | 10.1 | | ← | | | | | | | | | | | | | | | | | | | | | | | | | | | | | | | | | | | | | | | | | | |
| 2: | *10.8 | | → | | | | | | | | | | | | | | | | | | | | | | | | | | | | | | | | | | | | | | | | | | |
| 3: | *10.6 | | → | | | | | | | | | | | | | | | | | | | | | | | | | | | | | | | | | | | | | | | | | | |
| 4: | *10.6 | | ← | | | | | | | | | | | | | | | | | | | | | | | | | | | | | | | | | | | | | | | | | | |
| 5: | *10.7 | | → | | | | | | | | | | | | | | | | | | | | | | | | | | | | | | | | | | | | | | | | | | |
| 6: | *10.5 | | → | | | | | | | | | | | | | | | | | | | | | | | | | | | | | | | | | | | | | | | | | | |
| 7: | *10.6 | | ↑ | | | | | | | | | | | | | | | | | | | | | | | | | | | | | | | | | | | | | | | | | | |
| 8: | *10.8 | | ↗ | | | | | | | | | | | | | | | | | | | | | | | | | | | | | | | | | | | | | | | | | | |
| 9: | 10.2 | | ← | | | | | | | | | | | | | | | | | | | | | | | | | | | | | | | | | | | | | | | | | | |
| 10: | 10.5 | | ← | | | | | | | | | | | | | | | | | | | | | | | | | | | | | | | | | | | | | | | | | | |
| Serie | 105.4 | | | | | | | | | | | | | | | | | | | | | | | | | | | | | | | | | | | | | | | | | | | | |
| Total | 504.4 | | | | | | | | | | | | | | | | | | | | | | | | | | | | | | | | | | | | | | | | | | | | |

Hold
31

Skive
7

Mathias Christensen

Vilsted Skf.

FB2

Prøve

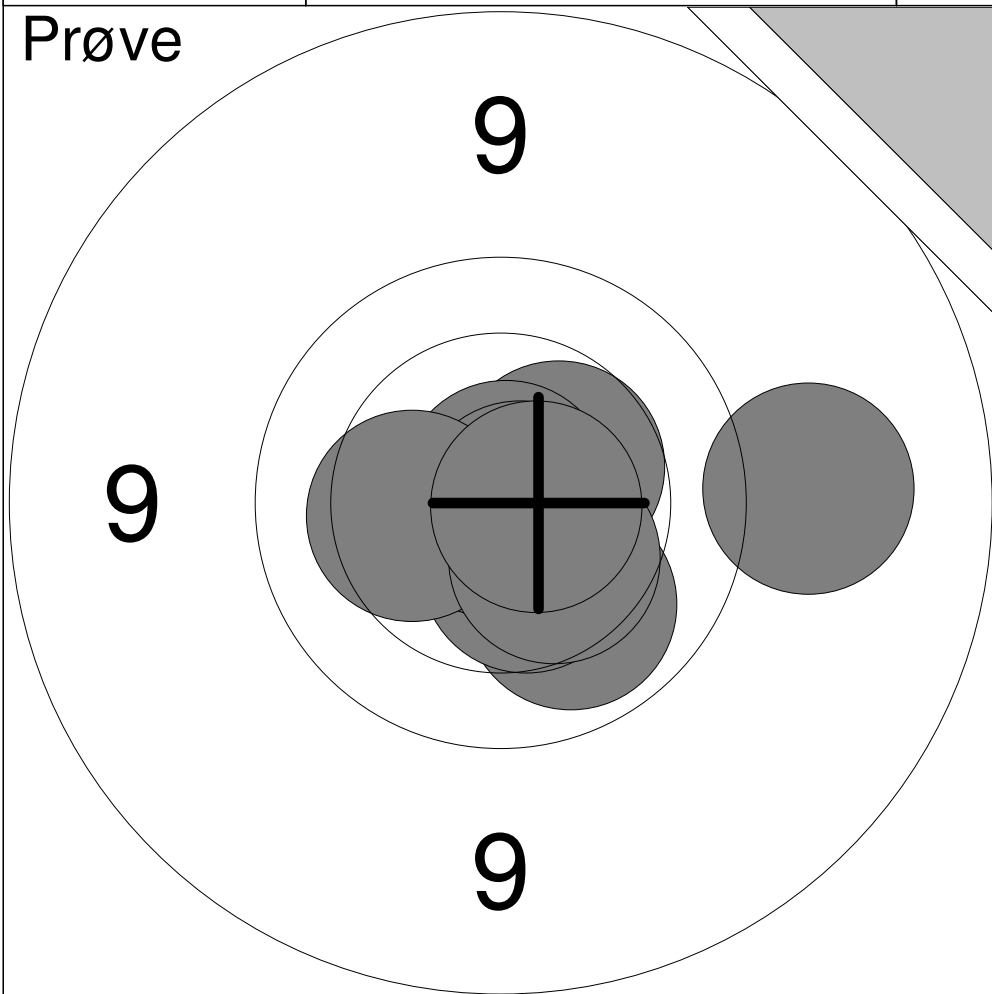

| | | |
|-----|-------|---|
| 1: | 9.3 | → |
| 2: | 10.1 | ↘ |
| 3: | 10.5 | ↘ |
| 4: | *10.9 | ↘ |
| 5: | 10.5 | ↗ |
| 6: | *10.8 | ↗ |
| 7: | *10.8 | → |
| 8: | 10.3 | ← |
| 9: | 10.4 | ↘ |
| 10: | *10.7 | → |

Serie 104.3

Total 399.0

Finale

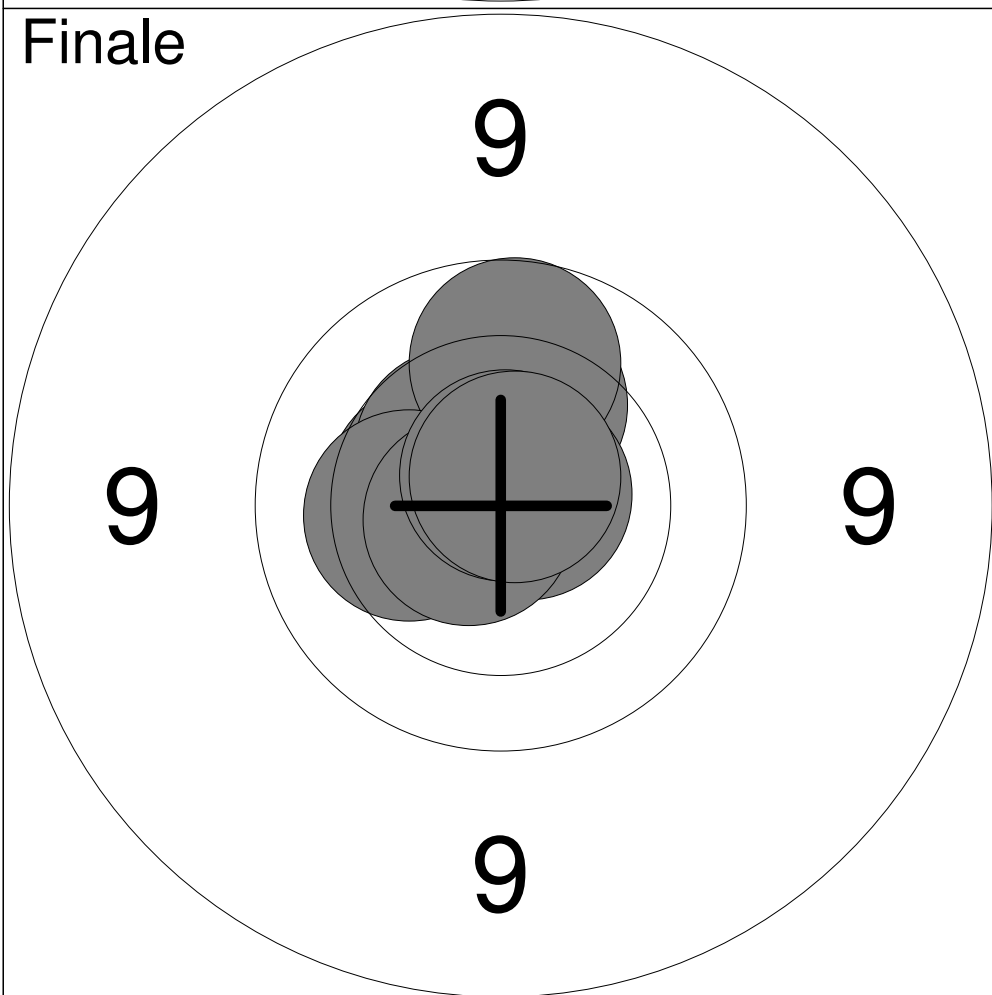

| | | |
|-----|-------|---|
| 1: | 10.2 | ↑ |
| 2: | 10.4 | ← |
| 3: | *10.8 | ← |
| 4: | 10.5 | ↗ |
| 5: | *10.7 | ↗ |
| 6: | 9.9 | ↑ |
| 7: | 10.3 | ← |
| 8: | *10.7 | ← |
| 9: | *10.7 | ↑ |
| 10: | *10.7 | ↗ |

Serie 104.9

Total 503.9

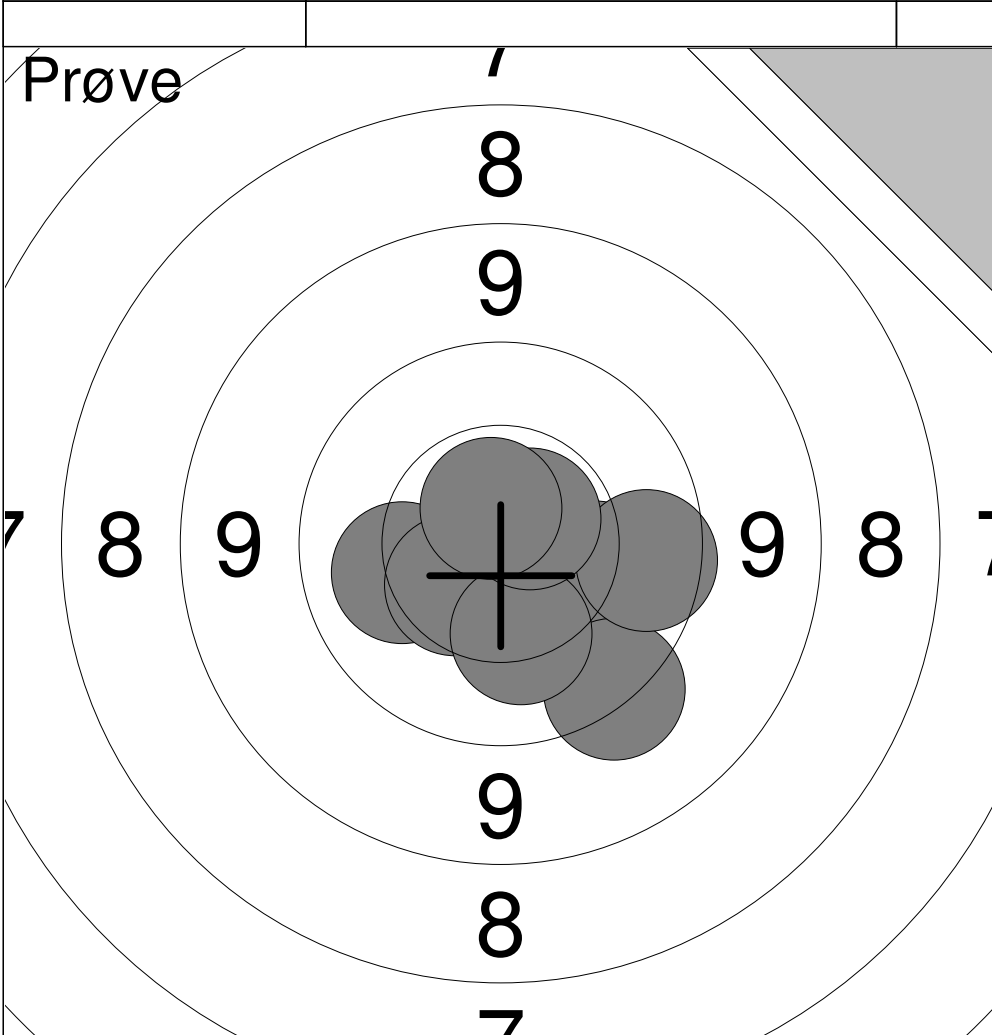

| | | |
|----|-------|---|
| 1: | 10.2 | ↖ |
| 2: | 10.5 | ↙ |
| 3: | 10.2 | → |
| 4: | 9.5 | ↘ |
| 5: | 10.2 | ↙ |
| 6: | 9.8 | → |
| 7: | *10.7 | ↗ |
| 8: | *10.7 | ↖ |

| | |
|-------|-------|
| Serie | 81.8 |
| Total | 398.0 |

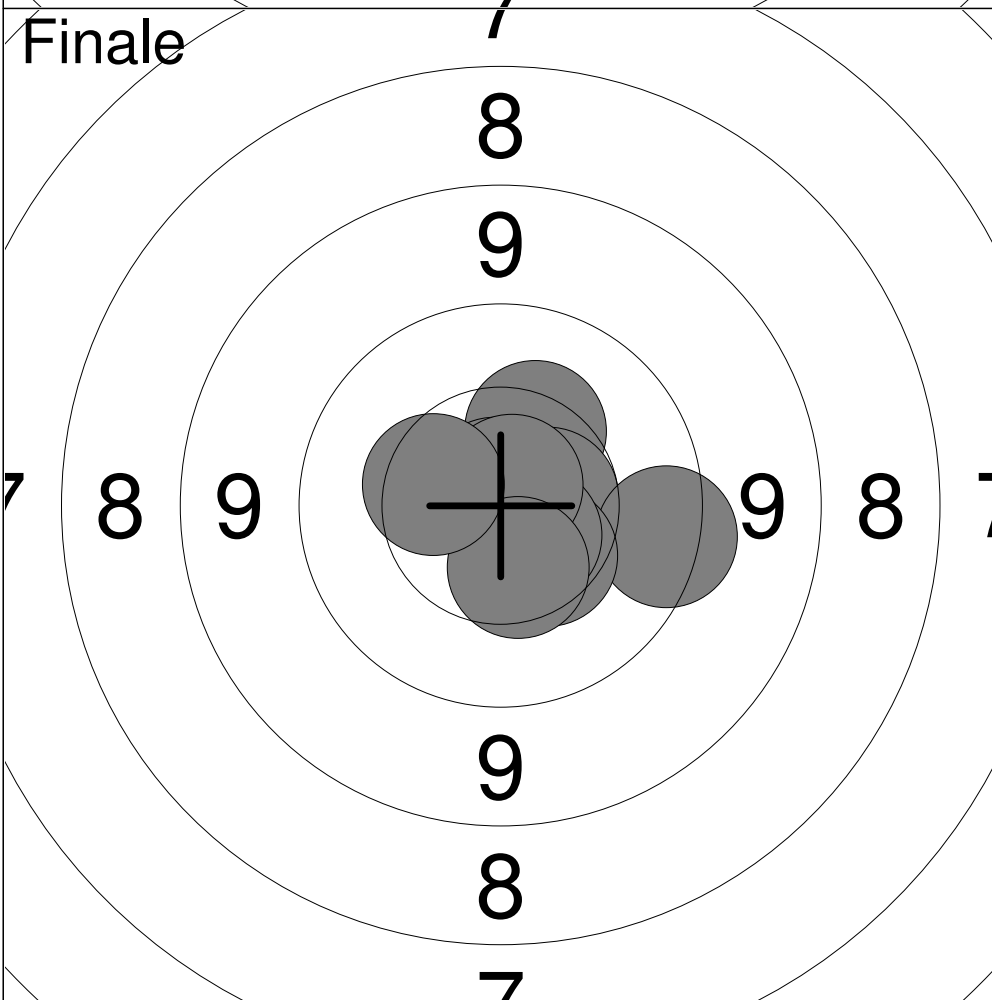

| | | |
|-----|-------|---|
| 1: | 10.3 | ↗ |
| 2: | 10.5 | ↘ |
| 3: | *10.8 | ↗ |
| 4: | *10.6 | → |
| 5: | 9.6 | ↘ |
| 6: | 10.4 | ↘ |
| 7: | *10.6 | ↘ |
| 8: | *10.8 | ↗ |
| 9: | 10.5 | ↘ |
| 10: | 10.4 | ↖ |

| | |
|-------|-------|
| Serie | 104.5 |
| Total | 502.5 |

Hold
31

Skive
9

Martin Jensen

Løgstør Skyttelaug

FJL

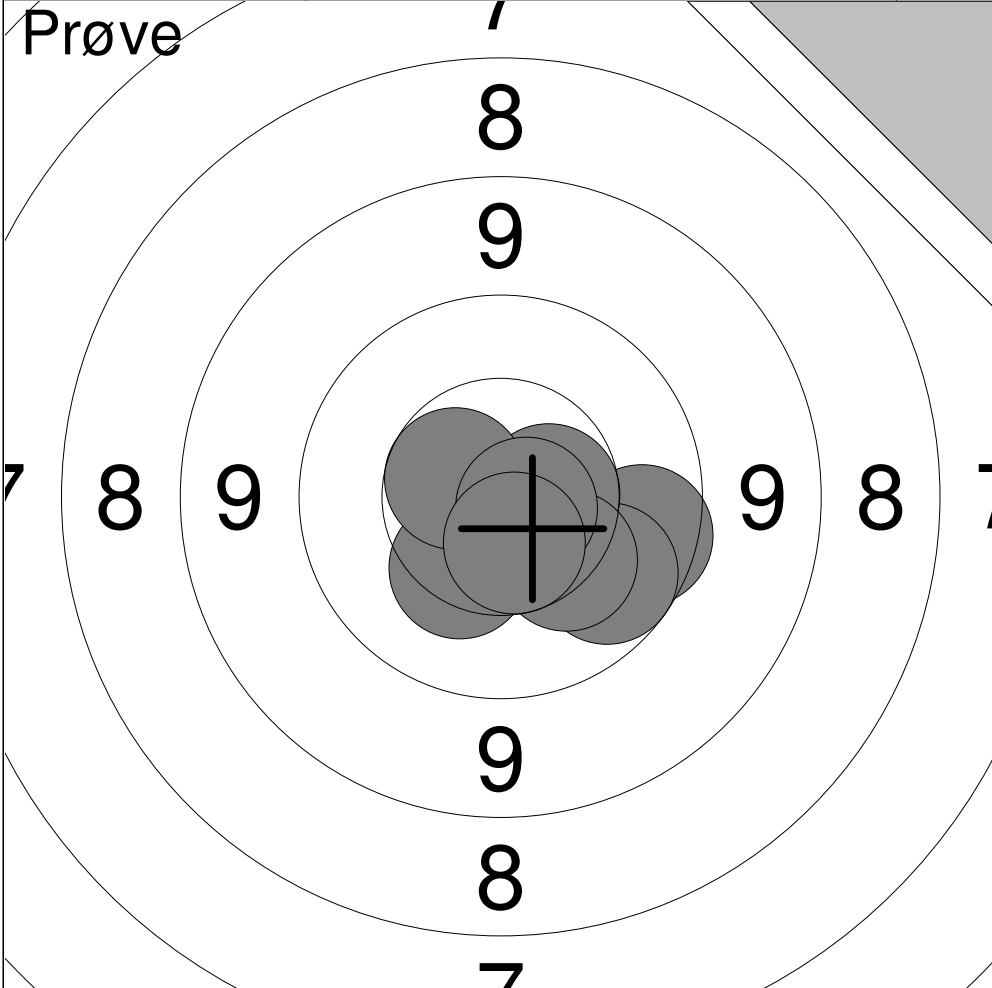

| | | |
|----|-------|---|
| 1: | 10.5 | ↘ |
| 2: | 9.8 | ↘ |
| 3: | 9.9 | ↘ |
| 4: | 10.6 | → |
| 5: | 10.3 | ↘ |
| 6: | 10.6 | ↗ |
| 7: | 10.2 | ↘ |
| 8: | *10.7 | ↘ |
| 9: | 10.6 | ↘ |

| | |
|-------|-------|
| Serie | 93.2 |
| Total | 397.0 |

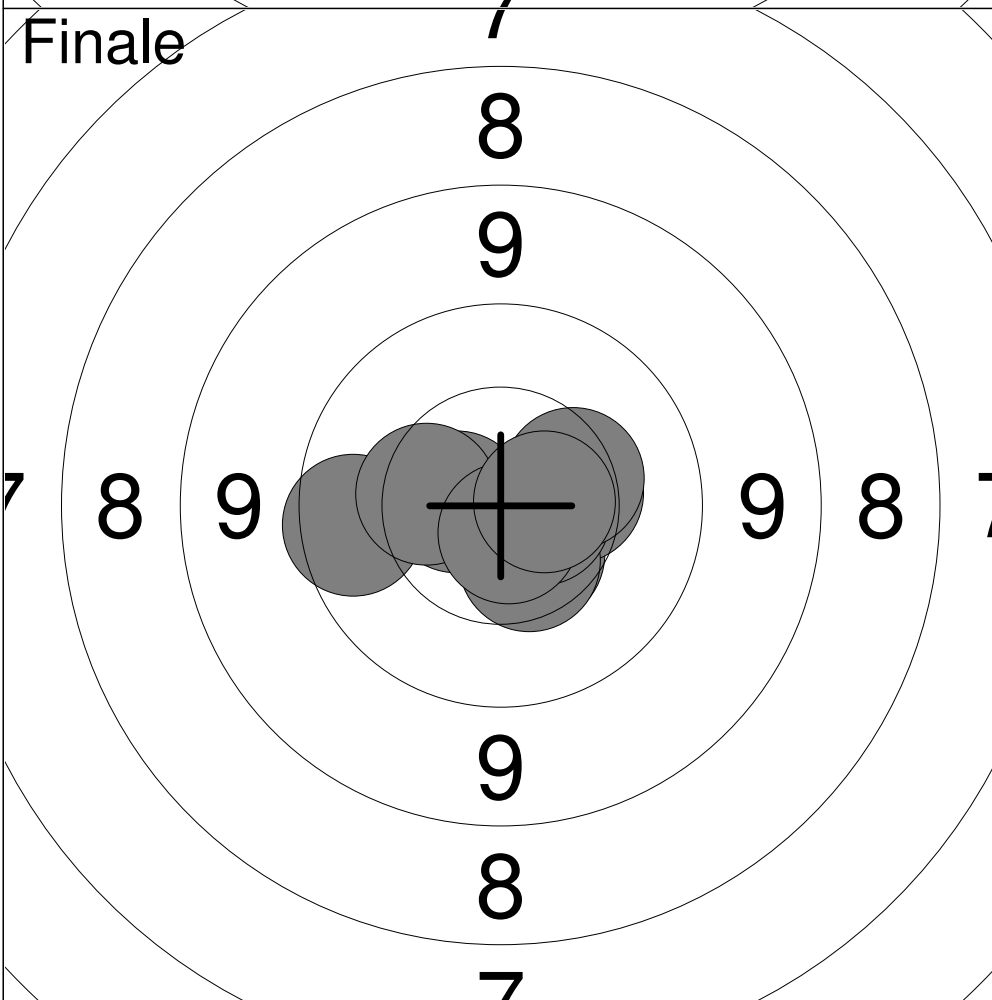

| | | |
|-----|-------|---|
| 1: | *10.6 | ← |
| 2: | 10.5 | ↘ |
| 3: | 10.4 | → |
| 4: | 10.5 | ↘ |
| 5: | 9.8 | ← |
| 6: | 10.4 | ← |
| 7: | *10.6 | ↘ |
| 8: | *10.7 | ↘ |
| 9: | 10.4 | → |
| 10: | *10.6 | → |

| | |
|-------|-------|
| Serie | 104.5 |
| Total | 501.5 |

| | | | | | | | | | | | | | | | | | | | | | | | | | | | | | | | |
|---------------------|---|----|------|---|----|-----|---|----|------|---|----|-----|---|----|-----|---|----|------|---|----|------|---|----|-------|---|----|------|---|-----|-----|---|
| <p>Prøve</p> | <table style="width:100%; border-collapse: collapse;"> <tr><td>1:</td><td>10.0</td><td style="text-align: right;">➔</td></tr> <tr><td>2:</td><td>9.9</td><td style="text-align: right;">➤</td></tr> <tr><td>3:</td><td>10.0</td><td style="text-align: right;">↑</td></tr> <tr><td>4:</td><td>9.4</td><td style="text-align: right;">➤</td></tr> <tr><td>5:</td><td>9.0</td><td style="text-align: right;">➤</td></tr> <tr><td>6:</td><td>10.5</td><td style="text-align: right;">➤</td></tr> <tr><td>7:</td><td>10.4</td><td style="text-align: right;">➤</td></tr> <tr><td>8:</td><td>*10.7</td><td style="text-align: right;">➤</td></tr> <tr><td>9:</td><td>10.4</td><td style="text-align: right;">↑</td></tr> <tr><td>10:</td><td>9.8</td><td style="text-align: right;">➤</td></tr> </table> | 1: | 10.0 | ➔ | 2: | 9.9 | ➤ | 3: | 10.0 | ↑ | 4: | 9.4 | ➤ | 5: | 9.0 | ➤ | 6: | 10.5 | ➤ | 7: | 10.4 | ➤ | 8: | *10.7 | ➤ | 9: | 10.4 | ↑ | 10: | 9.8 | ➤ |
| 1: | 10.0 | ➔ | | | | | | | | | | | | | | | | | | | | | | | | | | | | | |
| 2: | 9.9 | ➤ | | | | | | | | | | | | | | | | | | | | | | | | | | | | | |
| 3: | 10.0 | ↑ | | | | | | | | | | | | | | | | | | | | | | | | | | | | | |
| 4: | 9.4 | ➤ | | | | | | | | | | | | | | | | | | | | | | | | | | | | | |
| 5: | 9.0 | ➤ | | | | | | | | | | | | | | | | | | | | | | | | | | | | | |
| 6: | 10.5 | ➤ | | | | | | | | | | | | | | | | | | | | | | | | | | | | | |
| 7: | 10.4 | ➤ | | | | | | | | | | | | | | | | | | | | | | | | | | | | | |
| 8: | *10.7 | ➤ | | | | | | | | | | | | | | | | | | | | | | | | | | | | | |
| 9: | 10.4 | ↑ | | | | | | | | | | | | | | | | | | | | | | | | | | | | | |
| 10: | 9.8 | ➤ | | | | | | | | | | | | | | | | | | | | | | | | | | | | | |
| Serie | 100.1 | | | | | | | | | | | | | | | | | | | | | | | | | | | | | | |
| Total | 396.0 | | | | | | | | | | | | | | | | | | | | | | | | | | | | | | |

| | | | | | | | | | | | | | |
|---------------------|---|-----|------|---|-----|------|---|-----|------|---|-----|------|---|
| <p>Prøve</p> | <table style="width:100%; border-collapse: collapse;"> <tr><td>11:</td><td>10.2</td><td style="text-align: right;">➔</td></tr> <tr><td>12:</td><td>10.4</td><td style="text-align: right;">➤</td></tr> <tr><td>13:</td><td>10.4</td><td style="text-align: right;">➤</td></tr> <tr><td>14:</td><td>10.3</td><td style="text-align: right;">➤</td></tr> </table> | 11: | 10.2 | ➔ | 12: | 10.4 | ➤ | 13: | 10.4 | ➤ | 14: | 10.3 | ➤ |
| 11: | 10.2 | ➔ | | | | | | | | | | | |
| 12: | 10.4 | ➤ | | | | | | | | | | | |
| 13: | 10.4 | ➤ | | | | | | | | | | | |
| 14: | 10.3 | ➤ | | | | | | | | | | | |
| Serie | 41.3 | | | | | | | | | | | | |
| Total | 396.0 | | | | | | | | | | | | |

| | | | | | | | | | | | | | | | | | | | | | | | | | | | | | | | |
|----------------------|--|----|-------|---|----|------|---|----|------|---|----|------|---|----|------|---|----|------|---|----|------|---|----|-------|---|----|------|---|-----|------|---|
| <p>Finale</p> | <table style="width:100%; border-collapse: collapse;"> <tr><td>1:</td><td>*10.6</td><td style="text-align: right;">➤</td></tr> <tr><td>2:</td><td>10.1</td><td style="text-align: right;">↑</td></tr> <tr><td>3:</td><td>10.3</td><td style="text-align: right;">➤</td></tr> <tr><td>4:</td><td>10.2</td><td style="text-align: right;">➤</td></tr> <tr><td>5:</td><td>10.2</td><td style="text-align: right;">➤</td></tr> <tr><td>6:</td><td>10.5</td><td style="text-align: right;">↑</td></tr> <tr><td>7:</td><td>10.1</td><td style="text-align: right;">➤</td></tr> <tr><td>8:</td><td>*10.6</td><td style="text-align: right;">➤</td></tr> <tr><td>9:</td><td>10.4</td><td style="text-align: right;">➤</td></tr> <tr><td>10:</td><td>10.1</td><td style="text-align: right;">↑</td></tr> </table> | 1: | *10.6 | ➤ | 2: | 10.1 | ↑ | 3: | 10.3 | ➤ | 4: | 10.2 | ➤ | 5: | 10.2 | ➤ | 6: | 10.5 | ↑ | 7: | 10.1 | ➤ | 8: | *10.6 | ➤ | 9: | 10.4 | ➤ | 10: | 10.1 | ↑ |
| 1: | *10.6 | ➤ | | | | | | | | | | | | | | | | | | | | | | | | | | | | | |
| 2: | 10.1 | ↑ | | | | | | | | | | | | | | | | | | | | | | | | | | | | | |
| 3: | 10.3 | ➤ | | | | | | | | | | | | | | | | | | | | | | | | | | | | | |
| 4: | 10.2 | ➤ | | | | | | | | | | | | | | | | | | | | | | | | | | | | | |
| 5: | 10.2 | ➤ | | | | | | | | | | | | | | | | | | | | | | | | | | | | | |
| 6: | 10.5 | ↑ | | | | | | | | | | | | | | | | | | | | | | | | | | | | | |
| 7: | 10.1 | ➤ | | | | | | | | | | | | | | | | | | | | | | | | | | | | | |
| 8: | *10.6 | ➤ | | | | | | | | | | | | | | | | | | | | | | | | | | | | | |
| 9: | 10.4 | ➤ | | | | | | | | | | | | | | | | | | | | | | | | | | | | | |
| 10: | 10.1 | ↑ | | | | | | | | | | | | | | | | | | | | | | | | | | | | | |
| Serie | 103.1 | | | | | | | | | | | | | | | | | | | | | | | | | | | | | | |
| Total | 499.1 | | | | | | | | | | | | | | | | | | | | | | | | | | | | | | |

Hold
31

Skive
11

Marcus Edelbo

Aalborg Skyttekreds

FJL

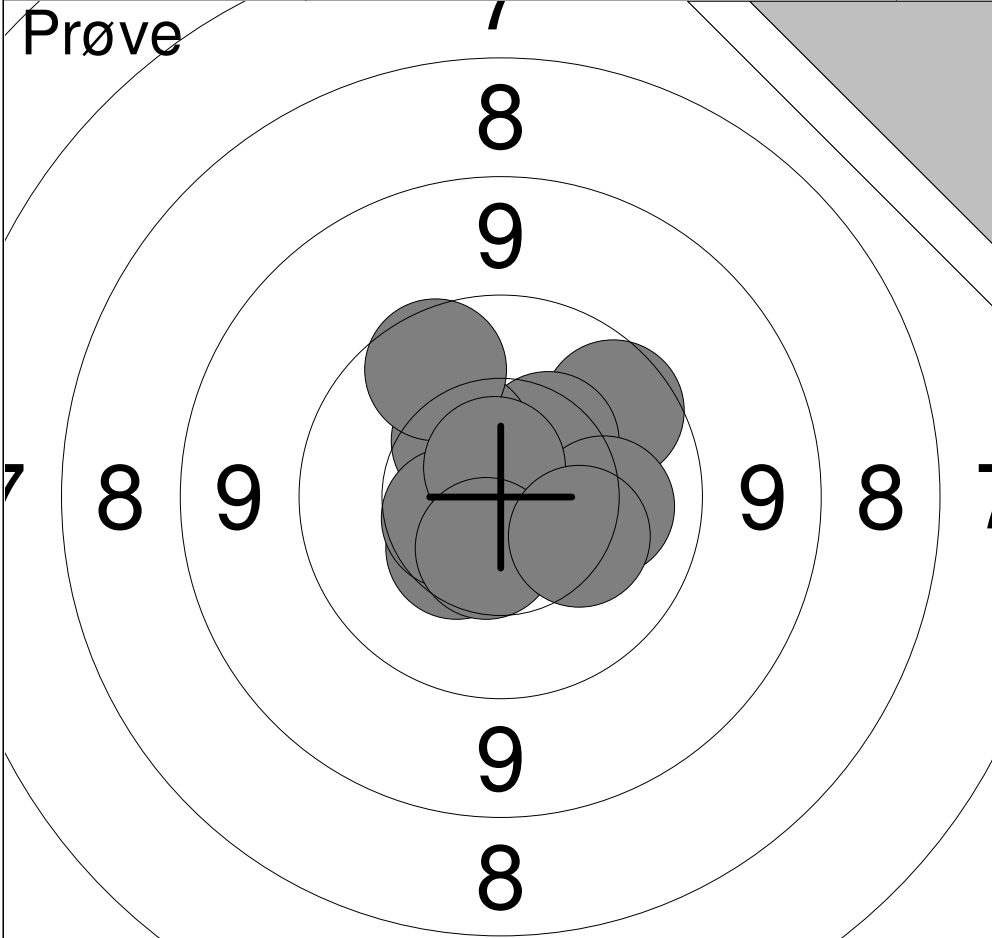

| | | |
|-----|-------|---|
| 1: | 9.9 | ↗ |
| 2: | 10.4 | ↗ |
| 3: | 10.4 | ↙ |
| 4: | 10.4 | ↗ |
| 5: | 10.2 | → |
| 6: | 9.9 | ↗ |
| 7: | 10.5 | ↙ |
| 8: | *10.7 | ↑ |
| 9: | 10.5 | ↘ |
| 10: | 10.3 | ↘ |

| | |
|-------|-------|
| Serie | 103.2 |
| Total | 396.0 |

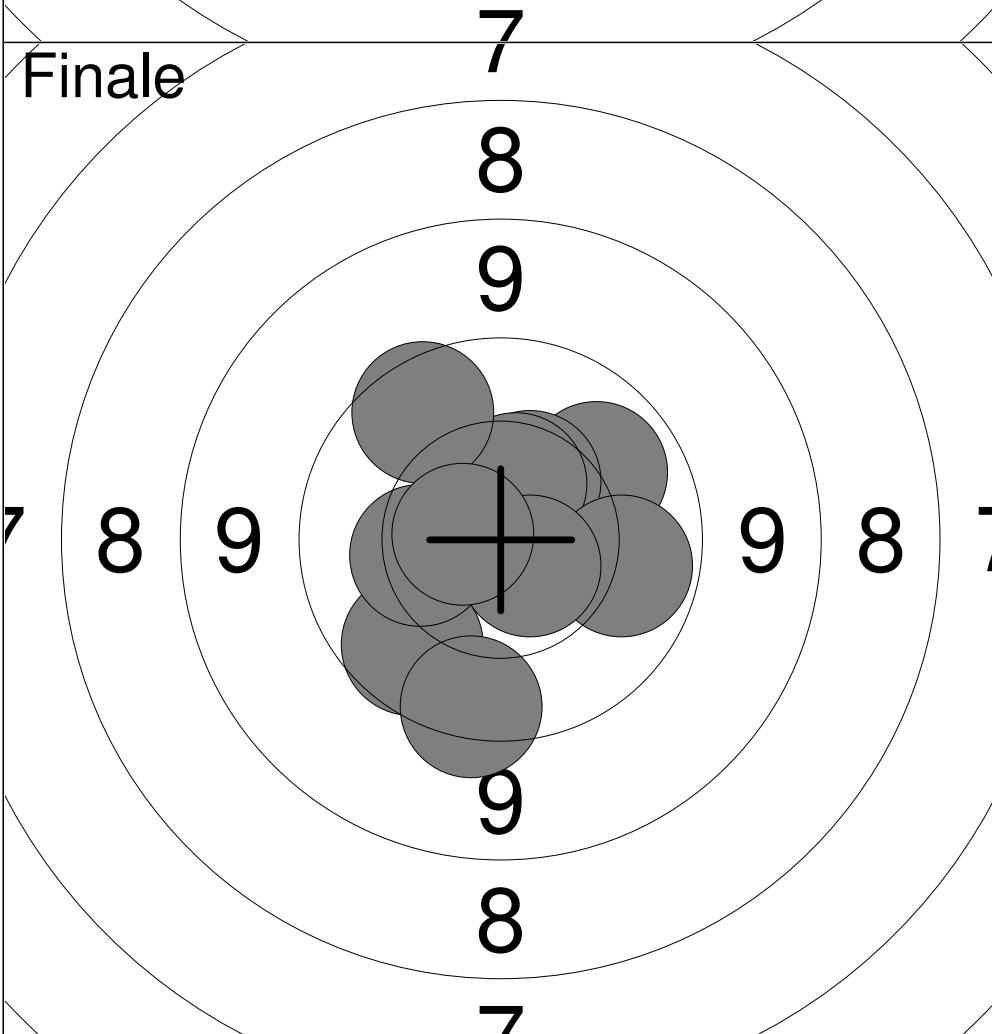

| | | |
|-----|-------|---|
| 1: | 10.1 | ↗ |
| 2: | 10.4 | ↗ |
| 3: | 9.9 | ↙ |
| 4: | 10.5 | ↗ |
| 5: | 10.0 | → |
| 6: | 9.6 | ↘ |
| 7: | *10.6 | ↘ |
| 8: | 9.8 | ↗ |
| 9: | 10.3 | ↙ |
| 10: | *10.7 | ↙ |

| | |
|-------|-------|
| Serie | 101.9 |
| Total | 497.9 |

Hold
31

Skive
12

Casper Krogh Frydkjær

Hjørring Skytteforening

FJL

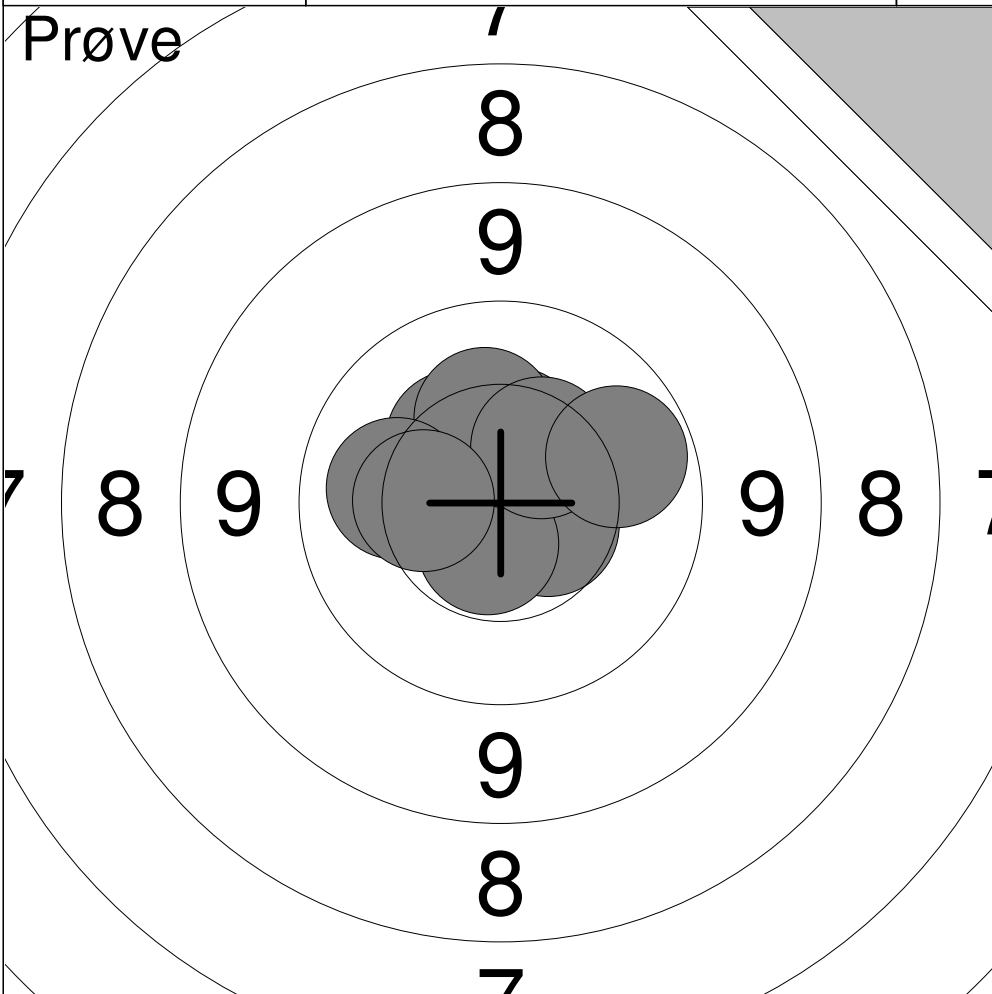

| | | |
|----|-------|---|
| 1: | 10.5 | ↘ |
| 2: | 10.4 | ↗ |
| 3: | *10.6 | ↙ |
| 4: | 10.4 | ↗ |
| 5: | 10.3 | ↗ |
| 6: | 10.4 | ↗ |
| 7: | 10.0 | ↗ |
| 8: | 10.1 | ↖ |
| 9: | 10.4 | ↖ |

| | |
|-------|-------|
| Serie | 93.1 |
| Total | 395.0 |

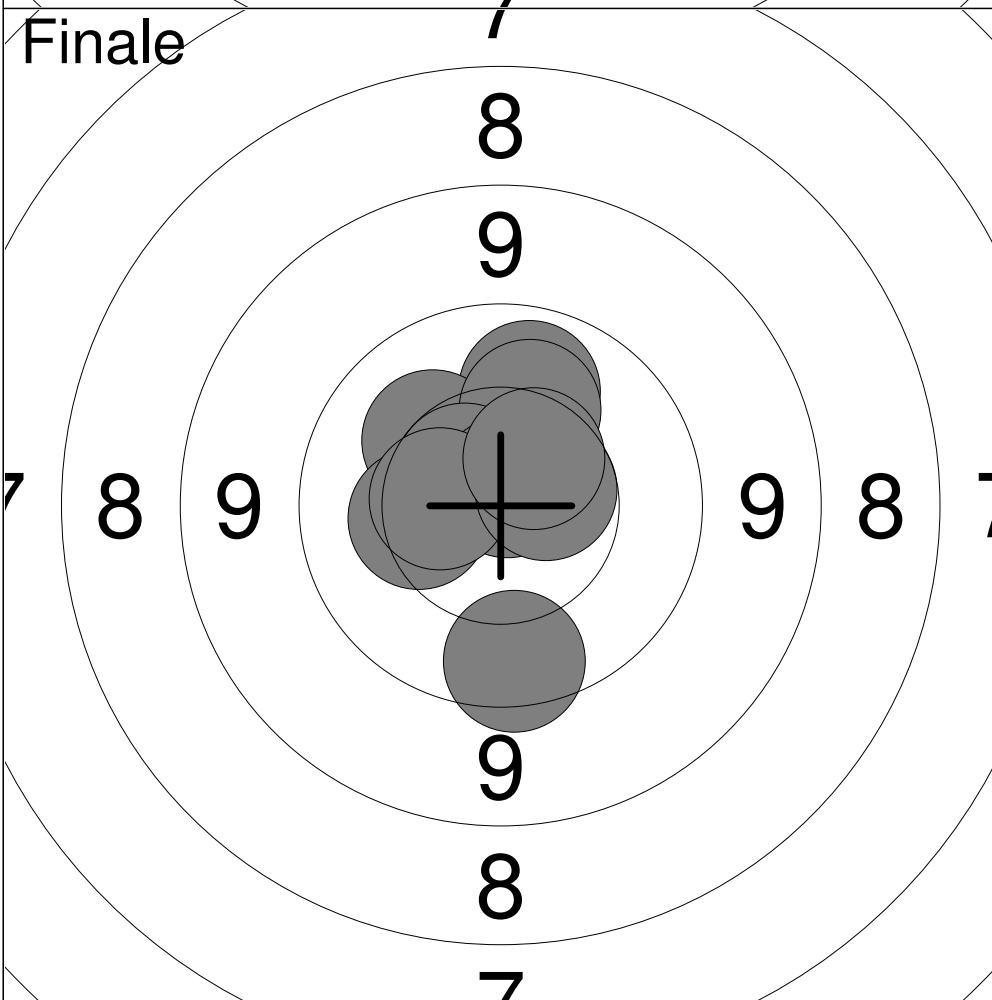

| | | |
|-----|-------|---|
| 1: | 10.0 | ↗ |
| 2: | 10.2 | ↗ |
| 3: | 10.2 | ↗ |
| 4: | *10.6 | ↗ |
| 5: | *10.8 | ↗ |
| 6: | 10.3 | ↖ |
| 7: | 10.5 | ↖ |
| 8: | 10.6 | ↗ |
| 9: | 10.5 | ↗ |
| 10: | 9.7 | ↙ |

| | |
|-------|-------|
| Serie | 103.4 |
| Total | 498.4 |

Hold
32

Skive
1

Martin Jensen

Løgstør Skyttelaug

FJ2

Prøve

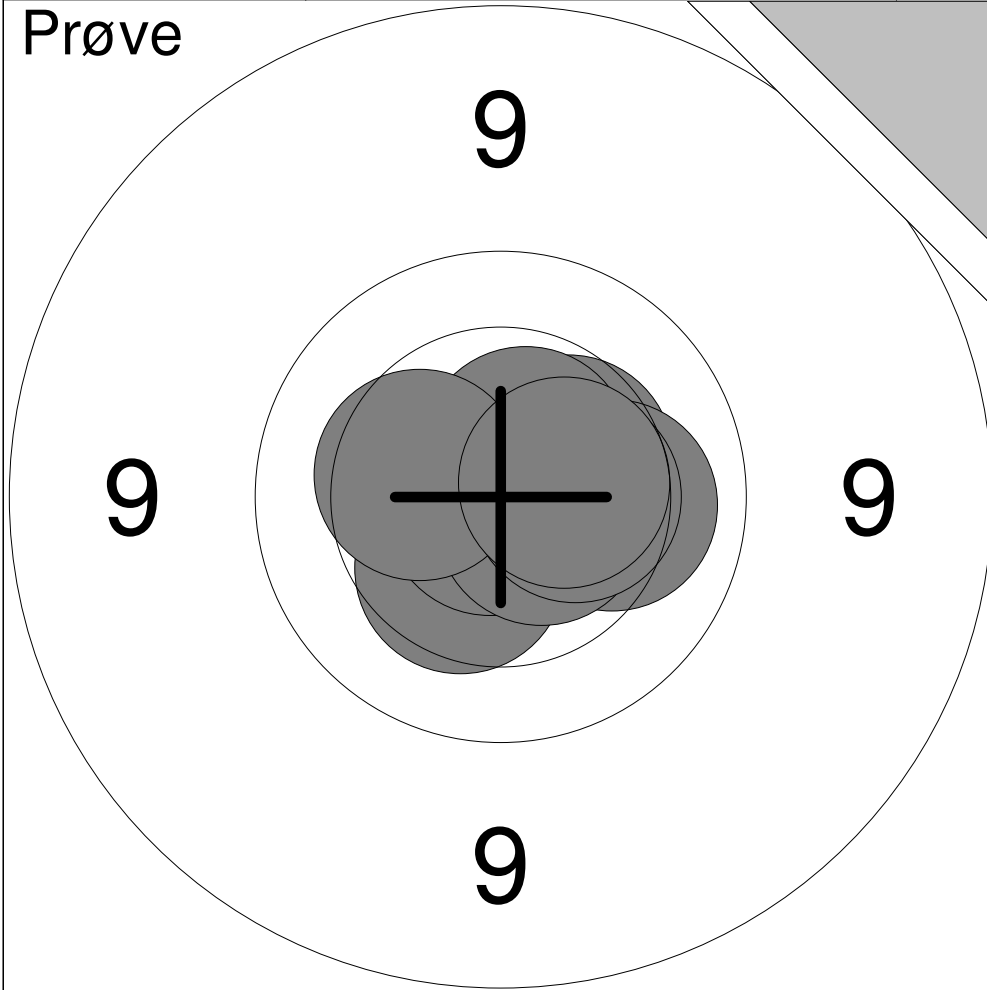

| | | |
|----|-------|---|
| 1: | 10.4 | ↙ |
| 2: | 10.4 | ↗ |
| 3: | 10.2 | → |
| 4: | *10.8 | ↙ |
| 5: | *10.6 | ↘ |
| 6: | *10.6 | ↗ |
| 7: | 10.4 | ← |
| 8: | 10.4 | → |
| 9: | 10.5 | → |

Serie 94.3

Total 399.0

Finale

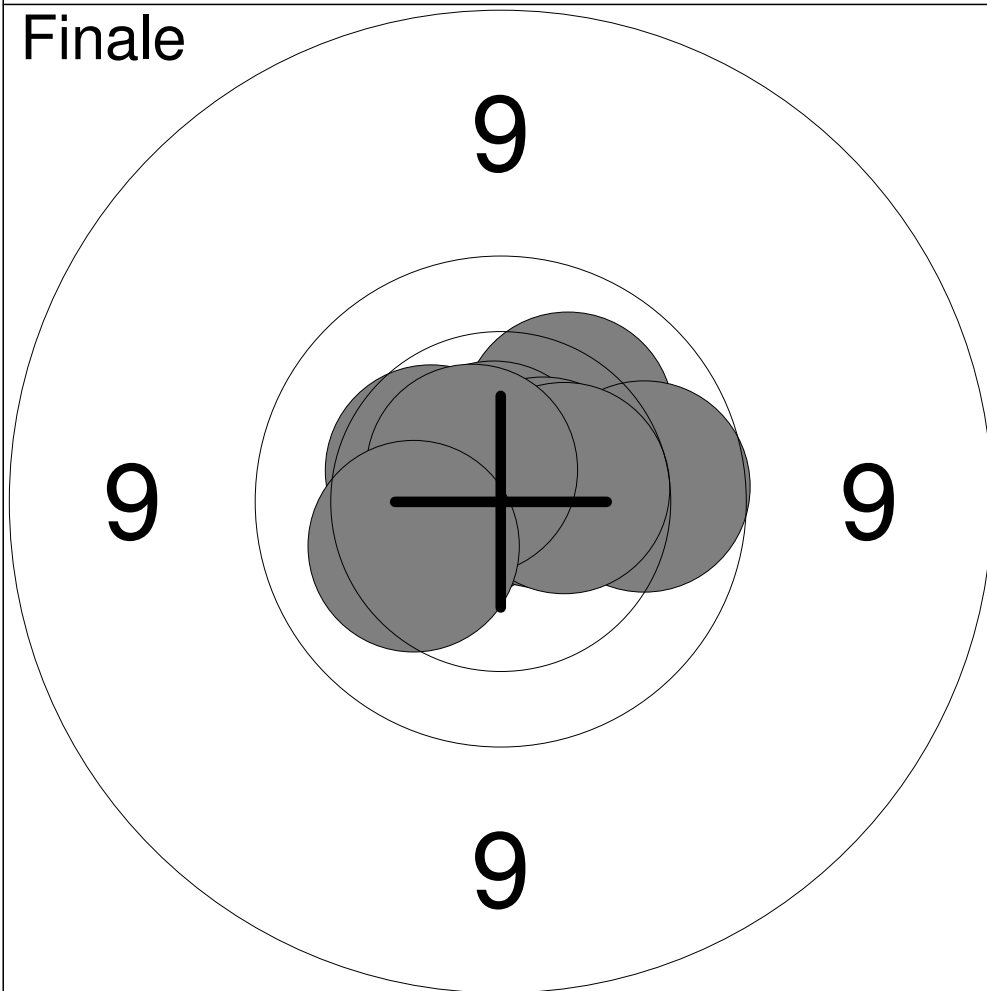

| | | |
|-----|-------|---|
| 1: | 10.2 | ↗ |
| 2: | 9.9 | → |
| 3: | *10.7 | ↗ |
| 4: | *10.6 | ← |
| 5: | *10.7 | ↑ |
| 6: | *10.6 | ↗ |
| 7: | 10.5 | → |
| 8: | 10.4 | ← |
| 9: | *10.6 | ↗ |
| 10: | 10.3 | ↙ |

Serie 104.5

Total 503.5

Hold
32

Skive
2

Benjamin Schou Thomsen

Hobro Egnens Skytteforening

FJ2

Prøve

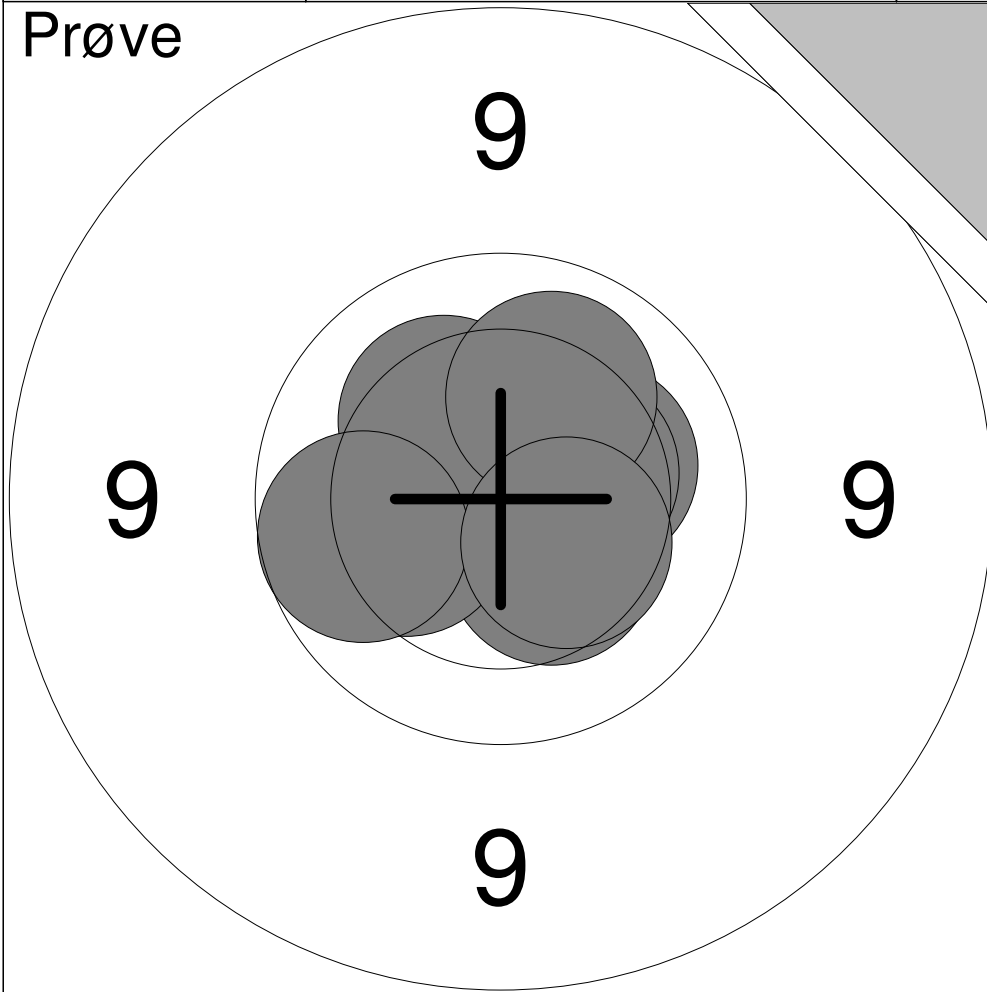

| | | |
|----|------|---|
| 1: | 10.4 | ↘ |
| 2: | 10.3 | ↗ |
| 3: | 10.2 | ↖ |
| 4: | 10.4 | ↗ |
| 5: | 10.3 | ↗ |
| 6: | 10.1 | ↗ |
| 7: | 9.9 | ↖ |
| 8: | 10.4 | ↘ |

Serie 82.0

Total 399.0

Finale

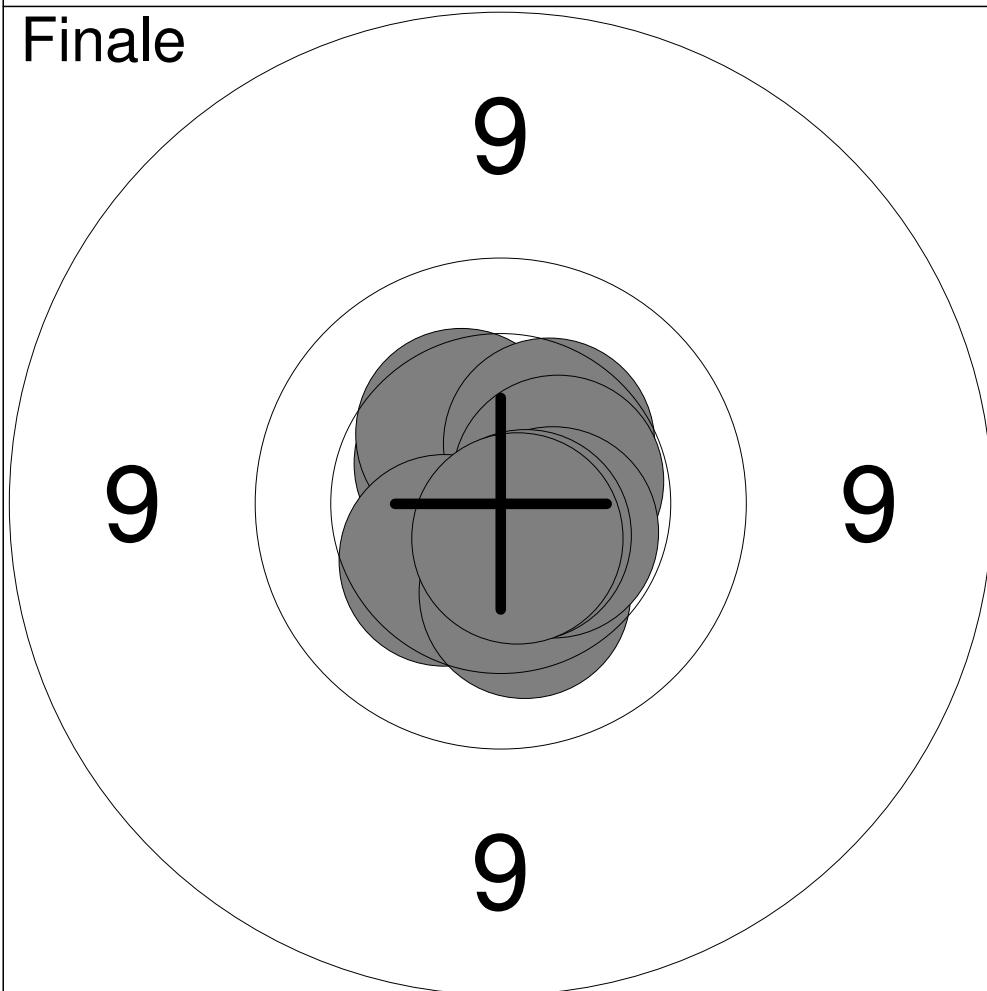

| | | |
|-----|-------|---|
| 1: | *10.8 | ↖ |
| 2: | *10.5 | ↗ |
| 3: | 10.4 | ↗ |
| 4: | 10.4 | ↗ |
| 5: | 10.4 | ↖ |
| 6: | *10.5 | ↗ |
| 7: | 10.3 | ↖ |
| 8: | *10.5 | ↘ |
| 9: | *10.7 | ↘ |
| 10: | *10.7 | ↘ |

Serie 105.2

Total 504.2

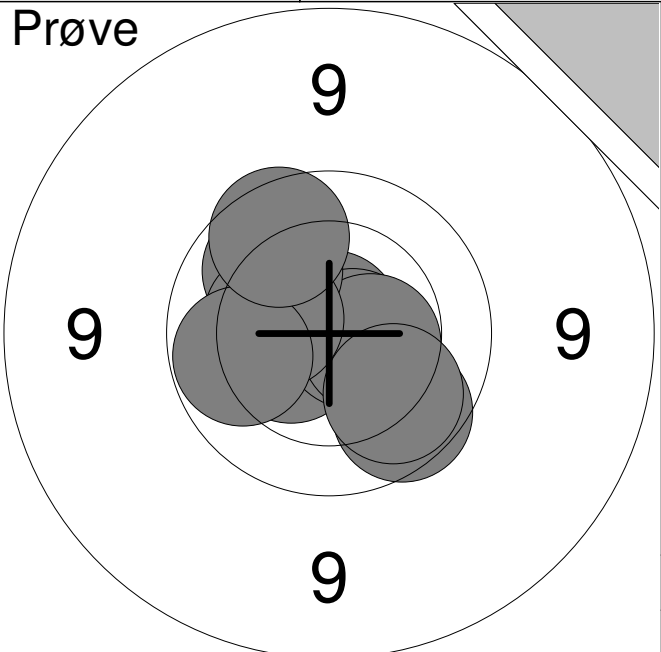
| | | | | | | | | | | | | | | | | | | | | | | | | | | | | | | | | | | | |
|--|---|----|-----|---|----|-------|---|----|------|---|----|-------|---|----|------|---|----|------|---|----|------|---|----|------|---|----|------|---|-----|-----|---|-------|-------|-------|-------|
| <p>Prøve</p>  | <table style="width:100%; border-collapse: collapse;"> <tr><td>1:</td><td>9.9</td><td>↘</td></tr> <tr><td>2:</td><td>*10.8</td><td>↑</td></tr> <tr><td>3:</td><td>10.5</td><td>↙</td></tr> <tr><td>4:</td><td>*10.7</td><td>→</td></tr> <tr><td>5:</td><td>10.5</td><td>↘</td></tr> <tr><td>6:</td><td>10.0</td><td>↘</td></tr> <tr><td>7:</td><td>10.0</td><td>↗</td></tr> <tr><td>8:</td><td>10.3</td><td>↑</td></tr> <tr><td>9:</td><td>10.0</td><td>↙</td></tr> <tr><td>10:</td><td>9.9</td><td>↗</td></tr> </table> <table border="1" style="width:100%; border-collapse: collapse; margin-top: 5px;"> <tr> <td style="width:80%;">Serie</td> <td style="text-align: right;">102.6</td> </tr> <tr> <td>Total</td> <td style="text-align: right;">398.0</td> </tr> </table> | 1: | 9.9 | ↘ | 2: | *10.8 | ↑ | 3: | 10.5 | ↙ | 4: | *10.7 | → | 5: | 10.5 | ↘ | 6: | 10.0 | ↘ | 7: | 10.0 | ↗ | 8: | 10.3 | ↑ | 9: | 10.0 | ↙ | 10: | 9.9 | ↗ | Serie | 102.6 | Total | 398.0 |
| 1: | 9.9 | ↘ | | | | | | | | | | | | | | | | | | | | | | | | | | | | | | | | | |
| 2: | *10.8 | ↑ | | | | | | | | | | | | | | | | | | | | | | | | | | | | | | | | | |
| 3: | 10.5 | ↙ | | | | | | | | | | | | | | | | | | | | | | | | | | | | | | | | | |
| 4: | *10.7 | → | | | | | | | | | | | | | | | | | | | | | | | | | | | | | | | | | |
| 5: | 10.5 | ↘ | | | | | | | | | | | | | | | | | | | | | | | | | | | | | | | | | |
| 6: | 10.0 | ↘ | | | | | | | | | | | | | | | | | | | | | | | | | | | | | | | | | |
| 7: | 10.0 | ↗ | | | | | | | | | | | | | | | | | | | | | | | | | | | | | | | | | |
| 8: | 10.3 | ↑ | | | | | | | | | | | | | | | | | | | | | | | | | | | | | | | | | |
| 9: | 10.0 | ↙ | | | | | | | | | | | | | | | | | | | | | | | | | | | | | | | | | |
| 10: | 9.9 | ↗ | | | | | | | | | | | | | | | | | | | | | | | | | | | | | | | | | |
| Serie | 102.6 | | | | | | | | | | | | | | | | | | | | | | | | | | | | | | | | | | |
| Total | 398.0 | | | | | | | | | | | | | | | | | | | | | | | | | | | | | | | | | | |

| | | | | | | | | | | | | | | | | | |
|---|---|-----|-------|---|-----|------|---|-----|------|---|-----|-------|---|-------|------|-------|-------|
| <p>Prøve</p>  | <table style="width:100%; border-collapse: collapse;"> <tr><td>11:</td><td>*10.6</td><td>↙</td></tr> <tr><td>12:</td><td>10.4</td><td>↘</td></tr> <tr><td>13:</td><td>10.1</td><td>↘</td></tr> <tr><td>14:</td><td>*10.6</td><td>↘</td></tr> </table> <table border="1" style="width:100%; border-collapse: collapse; margin-top: 5px;"> <tr> <td style="width:80%;">Serie</td> <td style="text-align: right;">41.7</td> </tr> <tr> <td>Total</td> <td style="text-align: right;">398.0</td> </tr> </table> | 11: | *10.6 | ↙ | 12: | 10.4 | ↘ | 13: | 10.1 | ↘ | 14: | *10.6 | ↘ | Serie | 41.7 | Total | 398.0 |
| 11: | *10.6 | ↙ | | | | | | | | | | | | | | | |
| 12: | 10.4 | ↘ | | | | | | | | | | | | | | | |
| 13: | 10.1 | ↘ | | | | | | | | | | | | | | | |
| 14: | *10.6 | ↘ | | | | | | | | | | | | | | | |
| Serie | 41.7 | | | | | | | | | | | | | | | | |
| Total | 398.0 | | | | | | | | | | | | | | | | |

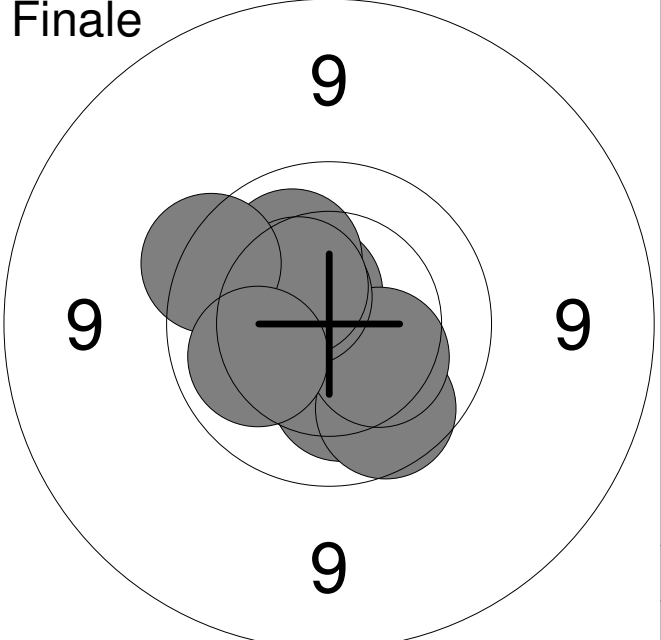
| | | | | | | | | | | | | | | | | | | | | | | | | | | | | | | | | | | | |
|---|---|----|-------|---|----|------|---|----|------|---|----|-----|---|----|------|---|----|-------|---|----|------|---|----|------|---|----|-----|---|-----|------|---|-------|-------|-------|-------|
| <p>Finale</p>  | <table style="width:100%; border-collapse: collapse;"> <tr><td>1:</td><td>*10.6</td><td>↗</td></tr> <tr><td>2:</td><td>10.2</td><td>↙</td></tr> <tr><td>3:</td><td>10.2</td><td>↘</td></tr> <tr><td>4:</td><td>9.9</td><td>↘</td></tr> <tr><td>5:</td><td>10.3</td><td>↘</td></tr> <tr><td>6:</td><td>*10.5</td><td>↗</td></tr> <tr><td>7:</td><td>10.1</td><td>↗</td></tr> <tr><td>8:</td><td>10.4</td><td>↗</td></tr> <tr><td>9:</td><td>9.7</td><td>↗</td></tr> <tr><td>10:</td><td>10.1</td><td>↙</td></tr> </table> <table border="1" style="width:100%; border-collapse: collapse; margin-top: 5px;"> <tr> <td style="width:80%;">Serie</td> <td style="text-align: right;">102.0</td> </tr> <tr> <td>Total</td> <td style="text-align: right;">500.0</td> </tr> </table> | 1: | *10.6 | ↗ | 2: | 10.2 | ↙ | 3: | 10.2 | ↘ | 4: | 9.9 | ↘ | 5: | 10.3 | ↘ | 6: | *10.5 | ↗ | 7: | 10.1 | ↗ | 8: | 10.4 | ↗ | 9: | 9.7 | ↗ | 10: | 10.1 | ↙ | Serie | 102.0 | Total | 500.0 |
| 1: | *10.6 | ↗ | | | | | | | | | | | | | | | | | | | | | | | | | | | | | | | | | |
| 2: | 10.2 | ↙ | | | | | | | | | | | | | | | | | | | | | | | | | | | | | | | | | |
| 3: | 10.2 | ↘ | | | | | | | | | | | | | | | | | | | | | | | | | | | | | | | | | |
| 4: | 9.9 | ↘ | | | | | | | | | | | | | | | | | | | | | | | | | | | | | | | | | |
| 5: | 10.3 | ↘ | | | | | | | | | | | | | | | | | | | | | | | | | | | | | | | | | |
| 6: | *10.5 | ↗ | | | | | | | | | | | | | | | | | | | | | | | | | | | | | | | | | |
| 7: | 10.1 | ↗ | | | | | | | | | | | | | | | | | | | | | | | | | | | | | | | | | |
| 8: | 10.4 | ↗ | | | | | | | | | | | | | | | | | | | | | | | | | | | | | | | | | |
| 9: | 9.7 | ↗ | | | | | | | | | | | | | | | | | | | | | | | | | | | | | | | | | |
| 10: | 10.1 | ↙ | | | | | | | | | | | | | | | | | | | | | | | | | | | | | | | | | |
| Serie | 102.0 | | | | | | | | | | | | | | | | | | | | | | | | | | | | | | | | | | |
| Total | 500.0 | | | | | | | | | | | | | | | | | | | | | | | | | | | | | | | | | | |

Hold
32

Skive
4

Adam Søtoft

Aalborg Skyttekreds

FJ2

Prøve

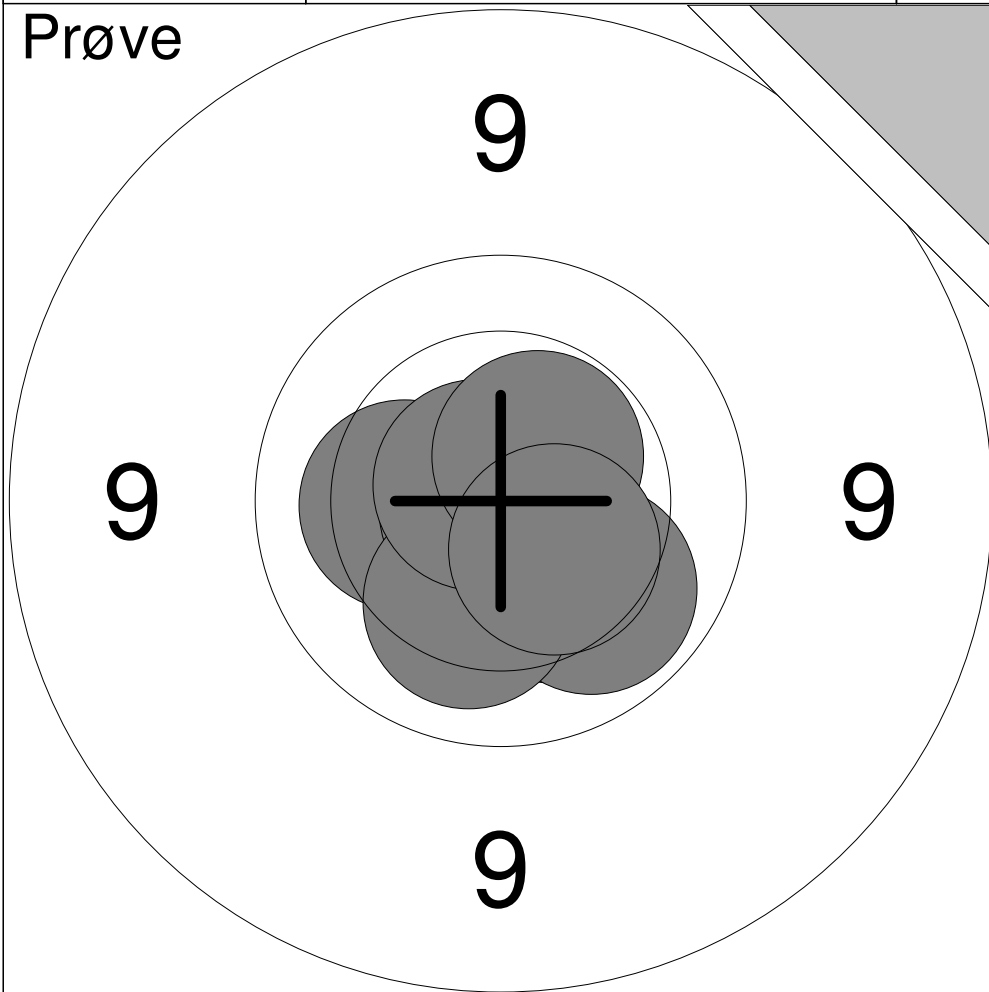

| | | |
|----|-------|---|
| 1: | 10.3 | ← |
| 2: | *10.8 | ← |
| 3: | 10.3 | ↘ |
| 4: | 10.0 | ↘ |
| 5: | 10.2 | ↘ |
| 6: | *10.8 | ↗ |
| 7: | *10.5 | ↗ |
| 8: | 10.4 | ↘ |

Serie 83.3

Total 398.0

Finale

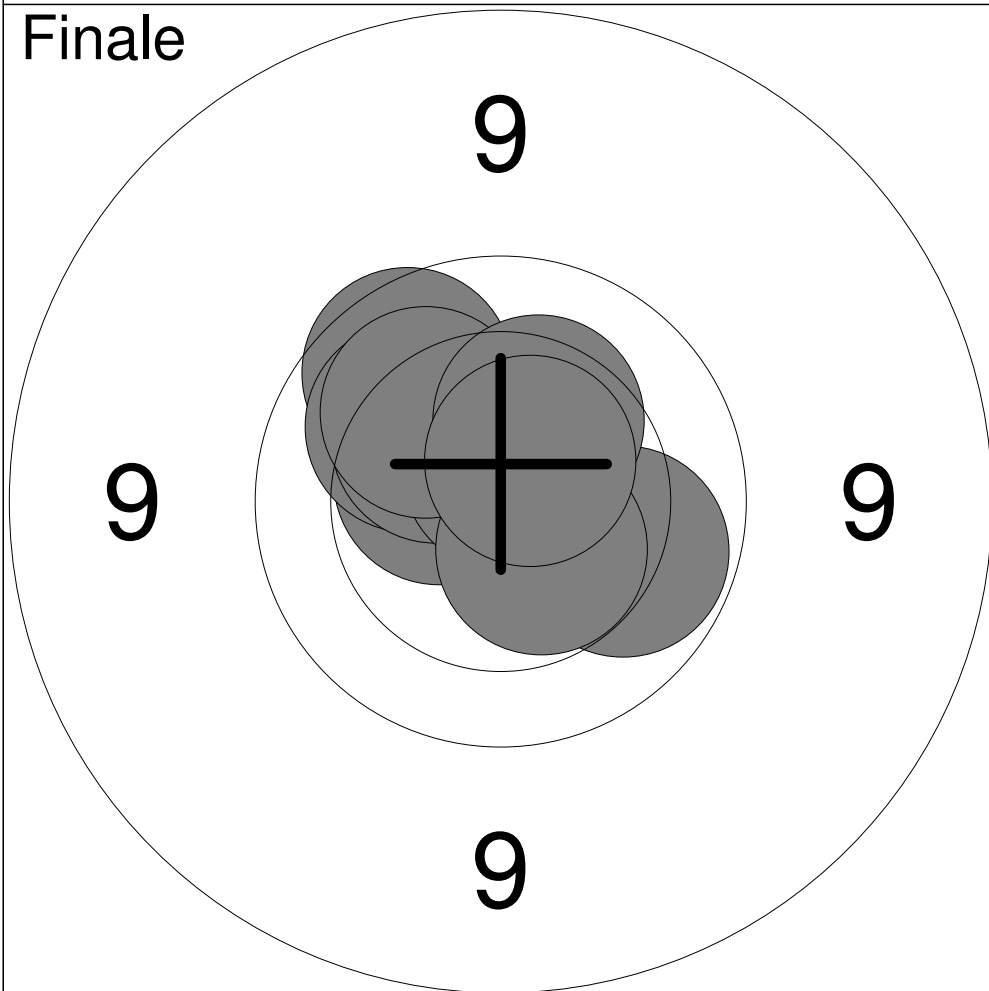

| | | |
|-----|-------|---|
| 1: | 9.9 | ↗ |
| 2: | 10.5 | ↗ |
| 3: | 10.0 | ↘ |
| 4: | 10.1 | ↗ |
| 5: | 10.3 | ↗ |
| 6: | *10.7 | ↗ |
| 7: | 10.1 | ↗ |
| 8: | 10.3 | ↗ |
| 9: | *10.5 | ↘ |
| 10: | *10.6 | ↗ |

Serie 103.0

Total 501.0

| | | | | | | | | | | | | | | | | | | | | | | | | | | | | | | | | | | | | | |
|--|--|--------------|-----|---|----|-------|---|----|-----|---|----|------|---|----|-------|---|----|-------|---|----|------|---|----|-------|---|----|------|---|-----|-----|---|--------------|--|--------------|--------------|--|--------------|
| <p>Prøve</p>  | <table style="width:100%; border-collapse: collapse;"> <tr><td style="width:10%;">1:</td><td style="width:15%;">9.8</td><td style="width:10%; text-align: right;">↗</td></tr> <tr><td>2:</td><td>*10.8</td><td style="text-align: right;">↘</td></tr> <tr><td>3:</td><td>9.8</td><td style="text-align: right;">↗</td></tr> <tr><td>4:</td><td>10.3</td><td style="text-align: right;">→</td></tr> <tr><td>5:</td><td>*10.6</td><td style="text-align: right;">↘</td></tr> <tr><td>6:</td><td>*10.5</td><td style="text-align: right;">↗</td></tr> <tr><td>7:</td><td>10.0</td><td style="text-align: right;">←</td></tr> <tr><td>8:</td><td>*10.5</td><td style="text-align: right;">↗</td></tr> <tr><td>9:</td><td>10.1</td><td style="text-align: right;">↗</td></tr> <tr><td>10:</td><td>9.9</td><td style="text-align: right;">←</td></tr> <tr><td colspan="2">Serie</td><td style="text-align: right;">102.3</td></tr> <tr><td colspan="2">Total</td><td style="text-align: right;">398.0</td></tr> </table> | 1: | 9.8 | ↗ | 2: | *10.8 | ↘ | 3: | 9.8 | ↗ | 4: | 10.3 | → | 5: | *10.6 | ↘ | 6: | *10.5 | ↗ | 7: | 10.0 | ← | 8: | *10.5 | ↗ | 9: | 10.1 | ↗ | 10: | 9.9 | ← | Serie | | 102.3 | Total | | 398.0 |
| 1: | 9.8 | ↗ | | | | | | | | | | | | | | | | | | | | | | | | | | | | | | | | | | | |
| 2: | *10.8 | ↘ | | | | | | | | | | | | | | | | | | | | | | | | | | | | | | | | | | | |
| 3: | 9.8 | ↗ | | | | | | | | | | | | | | | | | | | | | | | | | | | | | | | | | | | |
| 4: | 10.3 | → | | | | | | | | | | | | | | | | | | | | | | | | | | | | | | | | | | | |
| 5: | *10.6 | ↘ | | | | | | | | | | | | | | | | | | | | | | | | | | | | | | | | | | | |
| 6: | *10.5 | ↗ | | | | | | | | | | | | | | | | | | | | | | | | | | | | | | | | | | | |
| 7: | 10.0 | ← | | | | | | | | | | | | | | | | | | | | | | | | | | | | | | | | | | | |
| 8: | *10.5 | ↗ | | | | | | | | | | | | | | | | | | | | | | | | | | | | | | | | | | | |
| 9: | 10.1 | ↗ | | | | | | | | | | | | | | | | | | | | | | | | | | | | | | | | | | | |
| 10: | 9.9 | ← | | | | | | | | | | | | | | | | | | | | | | | | | | | | | | | | | | | |
| Serie | | 102.3 | | | | | | | | | | | | | | | | | | | | | | | | | | | | | | | | | | | |
| Total | | 398.0 | | | | | | | | | | | | | | | | | | | | | | | | | | | | | | | | | | | |

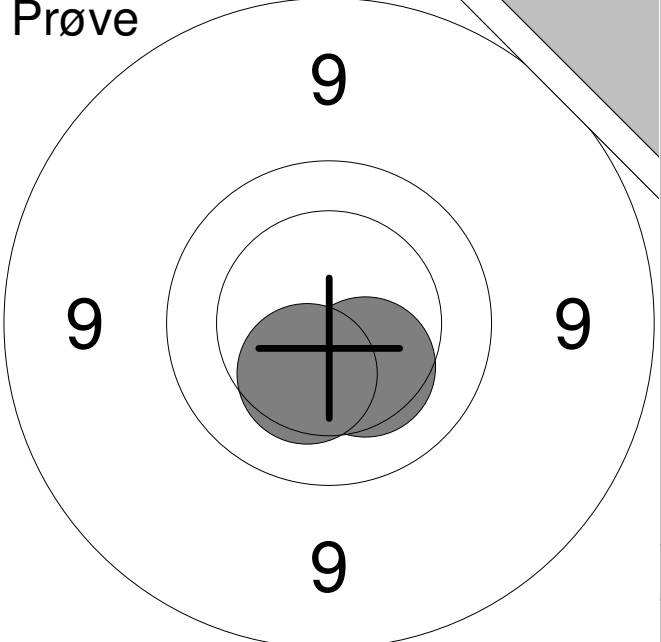
| | | | | | | | | | | | | | |
|---|---|--------------|------|---|-----|------|---|--------------|--|-------------|--------------|--|--------------|
| <p>Prøve</p>  | <table style="width:100%; border-collapse: collapse;"> <tr><td style="width:10%;">11:</td><td style="width:15%;">10.3</td><td style="width:10%; text-align: right;">↘</td></tr> <tr><td>12:</td><td>10.4</td><td style="text-align: right;">↘</td></tr> <tr><td colspan="2">Serie</td><td style="text-align: right;">20.7</td></tr> <tr><td colspan="2">Total</td><td style="text-align: right;">398.0</td></tr> </table> | 11: | 10.3 | ↘ | 12: | 10.4 | ↘ | Serie | | 20.7 | Total | | 398.0 |
| 11: | 10.3 | ↘ | | | | | | | | | | | |
| 12: | 10.4 | ↘ | | | | | | | | | | | |
| Serie | | 20.7 | | | | | | | | | | | |
| Total | | 398.0 | | | | | | | | | | | |

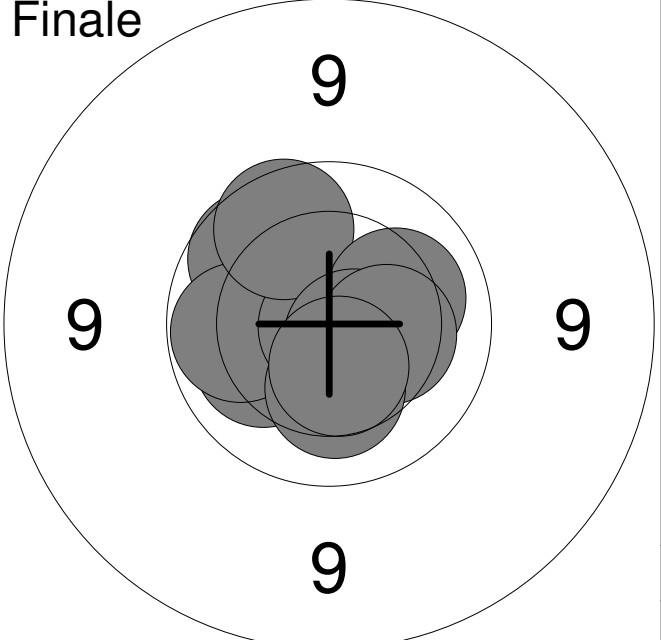
| | | | | | | | | | | | | | | | | | | | | | | | | | | | | | | | | | | | | | |
|---|---|--------------|------|---|----|-----|---|----|------|---|----|-------|---|----|-----|---|----|------|---|----|-------|---|----|------|---|----|------|---|-----|------|---|--------------|--|--------------|--------------|--|--------------|
| <p>Finale</p>  | <table style="width:100%; border-collapse: collapse;"> <tr><td style="width:10%;">1:</td><td style="width:15%;">10.2</td><td style="width:10%; text-align: right;">←</td></tr> <tr><td>2:</td><td>9.9</td><td style="text-align: right;">↗</td></tr> <tr><td>3:</td><td>10.0</td><td style="text-align: right;">←</td></tr> <tr><td>4:</td><td>*10.9</td><td style="text-align: right;">↘</td></tr> <tr><td>5:</td><td>9.9</td><td style="text-align: right;">↗</td></tr> <tr><td>6:</td><td>10.2</td><td style="text-align: right;">→</td></tr> <tr><td>7:</td><td>*10.6</td><td style="text-align: right;">↘</td></tr> <tr><td>8:</td><td>10.3</td><td style="text-align: right;">→</td></tr> <tr><td>9:</td><td>10.3</td><td style="text-align: right;">↘</td></tr> <tr><td>10:</td><td>10.5</td><td style="text-align: right;">↘</td></tr> <tr><td colspan="2">Serie</td><td style="text-align: right;">102.8</td></tr> <tr><td colspan="2">Total</td><td style="text-align: right;">500.8</td></tr> </table> | 1: | 10.2 | ← | 2: | 9.9 | ↗ | 3: | 10.0 | ← | 4: | *10.9 | ↘ | 5: | 9.9 | ↗ | 6: | 10.2 | → | 7: | *10.6 | ↘ | 8: | 10.3 | → | 9: | 10.3 | ↘ | 10: | 10.5 | ↘ | Serie | | 102.8 | Total | | 500.8 |
| 1: | 10.2 | ← | | | | | | | | | | | | | | | | | | | | | | | | | | | | | | | | | | | |
| 2: | 9.9 | ↗ | | | | | | | | | | | | | | | | | | | | | | | | | | | | | | | | | | | |
| 3: | 10.0 | ← | | | | | | | | | | | | | | | | | | | | | | | | | | | | | | | | | | | |
| 4: | *10.9 | ↘ | | | | | | | | | | | | | | | | | | | | | | | | | | | | | | | | | | | |
| 5: | 9.9 | ↗ | | | | | | | | | | | | | | | | | | | | | | | | | | | | | | | | | | | |
| 6: | 10.2 | → | | | | | | | | | | | | | | | | | | | | | | | | | | | | | | | | | | | |
| 7: | *10.6 | ↘ | | | | | | | | | | | | | | | | | | | | | | | | | | | | | | | | | | | |
| 8: | 10.3 | → | | | | | | | | | | | | | | | | | | | | | | | | | | | | | | | | | | | |
| 9: | 10.3 | ↘ | | | | | | | | | | | | | | | | | | | | | | | | | | | | | | | | | | | |
| 10: | 10.5 | ↘ | | | | | | | | | | | | | | | | | | | | | | | | | | | | | | | | | | | |
| Serie | | 102.8 | | | | | | | | | | | | | | | | | | | | | | | | | | | | | | | | | | | |
| Total | | 500.8 | | | | | | | | | | | | | | | | | | | | | | | | | | | | | | | | | | | |

| | | | | | | | | | | | | | | | | | | | | | | | | | | | | | | | | | | | |
|---------------------|--|----|-----|---|----|------|---|----|------|---|----|------|---|----|------|---|----|------|---|----|------|---|----|------|---|----|------|---|-----|------|---|-------|-------|-------|-------|
| <p>Prøve</p> | <table style="width:100%; border-collapse: collapse;"> <tr><td style="text-align: right;">1:</td><td style="text-align: right;">9.9</td><td style="text-align: right;">↗</td></tr> <tr><td style="text-align: right;">2:</td><td style="text-align: right;">10.1</td><td style="text-align: right;">←</td></tr> <tr><td style="text-align: right;">3:</td><td style="text-align: right;">10.1</td><td style="text-align: right;">↙</td></tr> <tr><td style="text-align: right;">4:</td><td style="text-align: right;">10.4</td><td style="text-align: right;">→</td></tr> <tr><td style="text-align: right;">5:</td><td style="text-align: right;">10.1</td><td style="text-align: right;">↘</td></tr> <tr><td style="text-align: right;">6:</td><td style="text-align: right;">10.3</td><td style="text-align: right;">↘</td></tr> <tr><td style="text-align: right;">7:</td><td style="text-align: right;">10.2</td><td style="text-align: right;">↙</td></tr> <tr><td style="text-align: right;">8:</td><td style="text-align: right;">10.3</td><td style="text-align: right;">→</td></tr> <tr><td style="text-align: right;">9:</td><td style="text-align: right;">10.1</td><td style="text-align: right;">→</td></tr> <tr><td style="text-align: right;">10:</td><td style="text-align: right;">10.0</td><td style="text-align: right;">↗</td></tr> </table> <table border="1" style="width:100%; border-collapse: collapse; margin-top: 5px;"> <tr> <td style="width:80%;">Serie</td> <td style="text-align: right;">101.5</td> </tr> <tr> <td>Total</td> <td style="text-align: right;">398.0</td> </tr> </table> | 1: | 9.9 | ↗ | 2: | 10.1 | ← | 3: | 10.1 | ↙ | 4: | 10.4 | → | 5: | 10.1 | ↘ | 6: | 10.3 | ↘ | 7: | 10.2 | ↙ | 8: | 10.3 | → | 9: | 10.1 | → | 10: | 10.0 | ↗ | Serie | 101.5 | Total | 398.0 |
| 1: | 9.9 | ↗ | | | | | | | | | | | | | | | | | | | | | | | | | | | | | | | | | |
| 2: | 10.1 | ← | | | | | | | | | | | | | | | | | | | | | | | | | | | | | | | | | |
| 3: | 10.1 | ↙ | | | | | | | | | | | | | | | | | | | | | | | | | | | | | | | | | |
| 4: | 10.4 | → | | | | | | | | | | | | | | | | | | | | | | | | | | | | | | | | | |
| 5: | 10.1 | ↘ | | | | | | | | | | | | | | | | | | | | | | | | | | | | | | | | | |
| 6: | 10.3 | ↘ | | | | | | | | | | | | | | | | | | | | | | | | | | | | | | | | | |
| 7: | 10.2 | ↙ | | | | | | | | | | | | | | | | | | | | | | | | | | | | | | | | | |
| 8: | 10.3 | → | | | | | | | | | | | | | | | | | | | | | | | | | | | | | | | | | |
| 9: | 10.1 | → | | | | | | | | | | | | | | | | | | | | | | | | | | | | | | | | | |
| 10: | 10.0 | ↗ | | | | | | | | | | | | | | | | | | | | | | | | | | | | | | | | | |
| Serie | 101.5 | | | | | | | | | | | | | | | | | | | | | | | | | | | | | | | | | | |
| Total | 398.0 | | | | | | | | | | | | | | | | | | | | | | | | | | | | | | | | | | |

| | | | | | | | | |
|---------------------|---|-----|------|---|-------|------|-------|-------|
| <p>Prøve</p> | <table style="width:100%; border-collapse: collapse;"> <tr> <td style="text-align: right;">11:</td> <td style="text-align: right;">10.0</td> <td style="text-align: right;">↙</td> </tr> </table> <table border="1" style="width:100%; border-collapse: collapse; margin-top: 5px;"> <tr> <td style="width:80%;">Serie</td> <td style="text-align: right;">10.0</td> </tr> <tr> <td>Total</td> <td style="text-align: right;">398.0</td> </tr> </table> | 11: | 10.0 | ↙ | Serie | 10.0 | Total | 398.0 |
| 11: | 10.0 | ↙ | | | | | | |
| Serie | 10.0 | | | | | | | |
| Total | 398.0 | | | | | | | |

| | | | | | | | | | | | | | | | | | | | | | | | | | | | | | | | | | | | |
|----------------------|--|----|------|---|----|------|---|----|------|---|----|------|---|----|------|---|----|------|---|----|-------|---|----|-------|---|----|------|---|-----|-------|---|-------|-------|-------|-------|
| <p>Finale</p> | <table style="width:100%; border-collapse: collapse;"> <tr><td style="text-align: right;">1:</td><td style="text-align: right;">10.3</td><td style="text-align: right;">←</td></tr> <tr><td style="text-align: right;">2:</td><td style="text-align: right;">10.1</td><td style="text-align: right;">←</td></tr> <tr><td style="text-align: right;">3:</td><td style="text-align: right;">10.2</td><td style="text-align: right;">→</td></tr> <tr><td style="text-align: right;">4:</td><td style="text-align: right;">10.3</td><td style="text-align: right;">→</td></tr> <tr><td style="text-align: right;">5:</td><td style="text-align: right;">10.4</td><td style="text-align: right;">↘</td></tr> <tr><td style="text-align: right;">6:</td><td style="text-align: right;">10.1</td><td style="text-align: right;">↘</td></tr> <tr><td style="text-align: right;">7:</td><td style="text-align: right;">*10.9</td><td style="text-align: right;">↗</td></tr> <tr><td style="text-align: right;">8:</td><td style="text-align: right;">*10.7</td><td style="text-align: right;">↗</td></tr> <tr><td style="text-align: right;">9:</td><td style="text-align: right;">10.5</td><td style="text-align: right;">←</td></tr> <tr><td style="text-align: right;">10:</td><td style="text-align: right;">*10.8</td><td style="text-align: right;">↗</td></tr> </table> <table border="1" style="width:100%; border-collapse: collapse; margin-top: 5px;"> <tr> <td style="width:80%;">Serie</td> <td style="text-align: right;">104.3</td> </tr> <tr> <td>Total</td> <td style="text-align: right;">502.3</td> </tr> </table> | 1: | 10.3 | ← | 2: | 10.1 | ← | 3: | 10.2 | → | 4: | 10.3 | → | 5: | 10.4 | ↘ | 6: | 10.1 | ↘ | 7: | *10.9 | ↗ | 8: | *10.7 | ↗ | 9: | 10.5 | ← | 10: | *10.8 | ↗ | Serie | 104.3 | Total | 502.3 |
| 1: | 10.3 | ← | | | | | | | | | | | | | | | | | | | | | | | | | | | | | | | | | |
| 2: | 10.1 | ← | | | | | | | | | | | | | | | | | | | | | | | | | | | | | | | | | |
| 3: | 10.2 | → | | | | | | | | | | | | | | | | | | | | | | | | | | | | | | | | | |
| 4: | 10.3 | → | | | | | | | | | | | | | | | | | | | | | | | | | | | | | | | | | |
| 5: | 10.4 | ↘ | | | | | | | | | | | | | | | | | | | | | | | | | | | | | | | | | |
| 6: | 10.1 | ↘ | | | | | | | | | | | | | | | | | | | | | | | | | | | | | | | | | |
| 7: | *10.9 | ↗ | | | | | | | | | | | | | | | | | | | | | | | | | | | | | | | | | |
| 8: | *10.7 | ↗ | | | | | | | | | | | | | | | | | | | | | | | | | | | | | | | | | |
| 9: | 10.5 | ← | | | | | | | | | | | | | | | | | | | | | | | | | | | | | | | | | |
| 10: | *10.8 | ↗ | | | | | | | | | | | | | | | | | | | | | | | | | | | | | | | | | |
| Serie | 104.3 | | | | | | | | | | | | | | | | | | | | | | | | | | | | | | | | | | |
| Total | 502.3 | | | | | | | | | | | | | | | | | | | | | | | | | | | | | | | | | | |

Hold
32

Skive
7

Christinna Herskind

Vadum Skf.

FBL

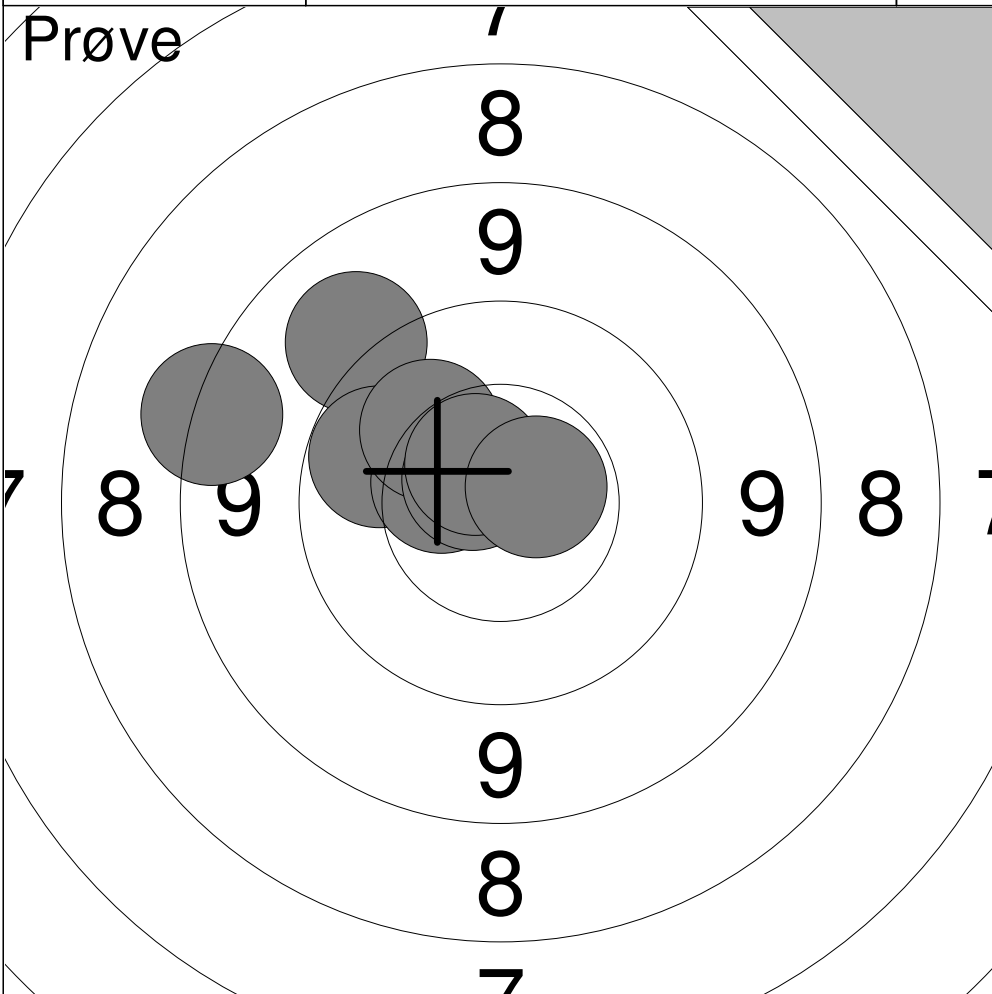

| | | |
|----|-------|---|
| 1: | 8.5 | ↖ |
| 2: | 9.2 | ↗ |
| 3: | 10.0 | ↖ |
| 4: | 10.5 | ↖ |
| 5: | 10.2 | ↗ |
| 6: | *10.7 | ↗ |
| 7: | *10.6 | ↗ |
| 8: | *10.6 | ↗ |

| | |
|-------|-------|
| Serie | 80.3 |
| Total | 400.0 |

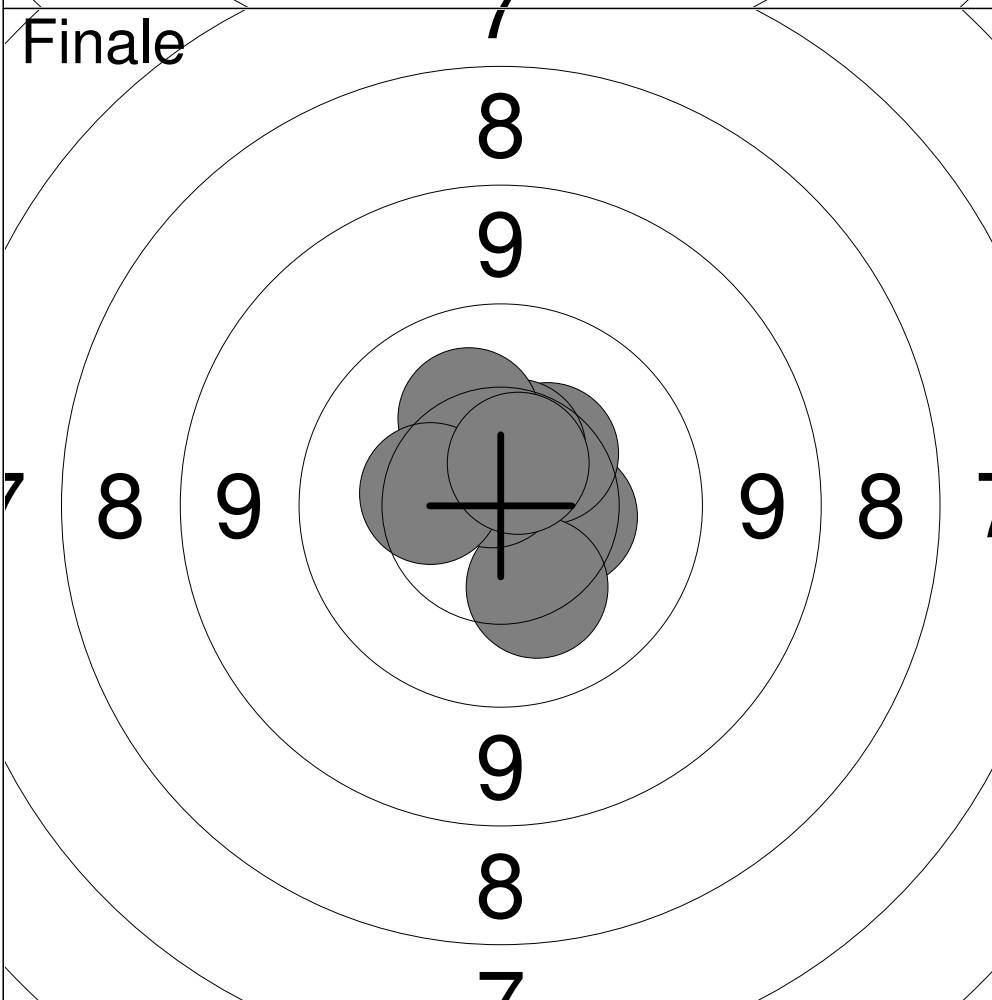

| | | |
|-----|-------|---|
| 1: | *10.6 | ↑ |
| 2: | *10.7 | ↗ |
| 3: | 10.4 | → |
| 4: | 10.4 | ↗ |
| 5: | 10.5 | ↑ |
| 6: | 10.3 | ↘ |
| 7: | *10.7 | ↖ |
| 8: | 10.2 | ↖ |
| 9: | 10.4 | ↖ |
| 10: | *10.6 | ↖ |

| | |
|-------|-------|
| Serie | 104.8 |
| Total | 504.8 |

Hold
32

Skive
8

Simon Mejdahl

Vilsted Skf.

FBL

Prøve

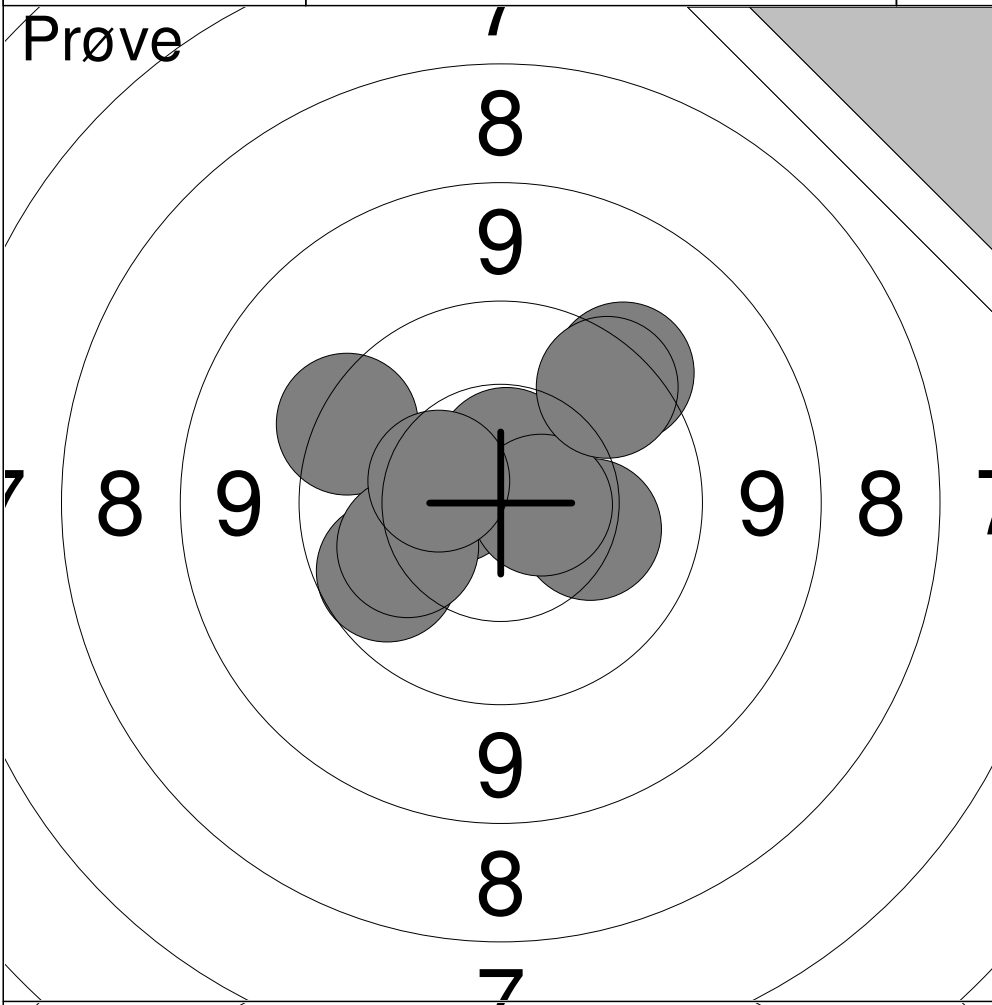

| | | |
|-----|-------|---|
| 1: | 10.6 | ← |
| 2: | 9.5 | ↗ |
| 3: | 9.6 | ↗ |
| 4: | 9.9 | ← |
| 5: | 10.2 | → |
| 6: | 10.2 | ← |
| 7: | *10.6 | ↑ |
| 8: | *10.6 | → |
| 9: | 10.4 | ← |
| 10: | 9.7 | ↗ |

| | |
|-------|-------|
| Serie | 101.3 |
| Total | 399.0 |

Finale

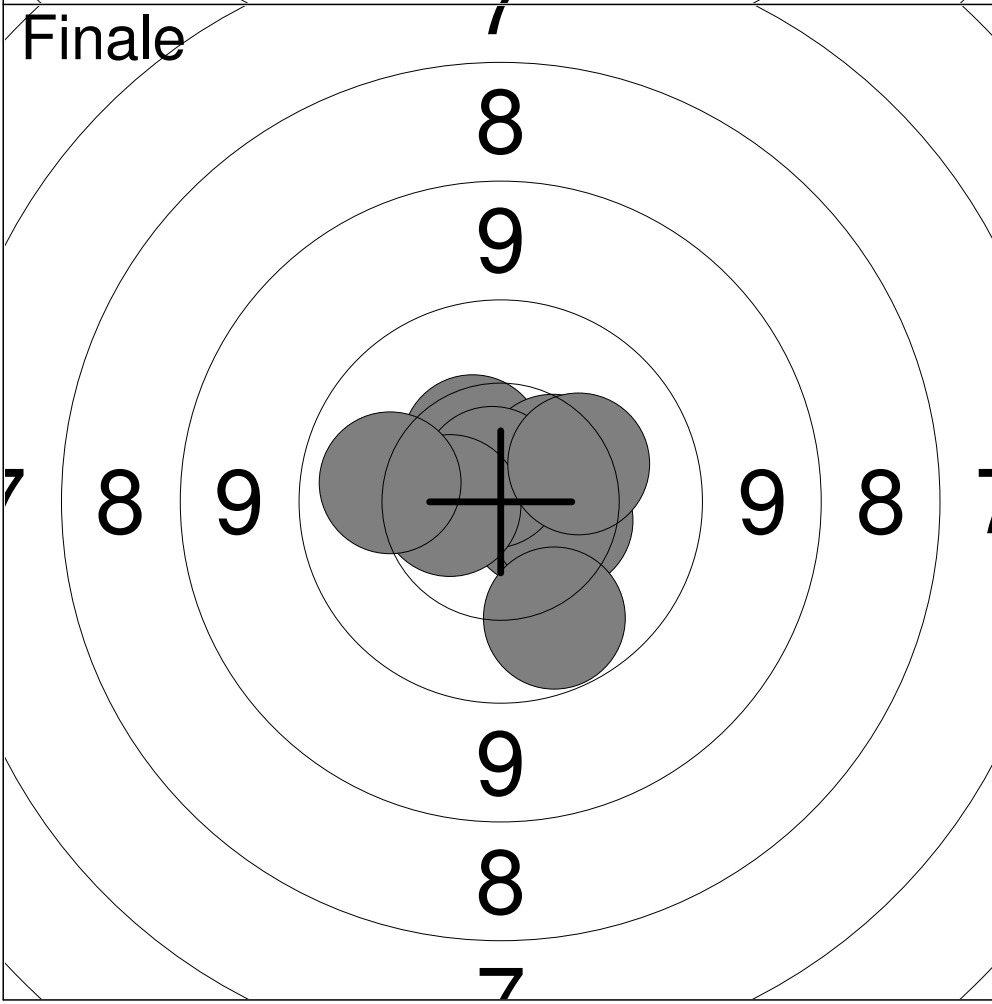

| | | |
|-----|-------|---|
| 1: | *10.7 | ↗ |
| 2: | 10.5 | ↗ |
| 3: | *10.6 | → |
| 4: | 10.5 | ↗ |
| 5: | 10.5 | → |
| 6: | *10.8 | ↗ |
| 7: | 10.6 | ← |
| 8: | 10.1 | ← |
| 9: | 10.3 | ↗ |
| 10: | 10.0 | ↘ |

| | |
|-------|-------|
| Serie | 104.6 |
| Total | 503.6 |

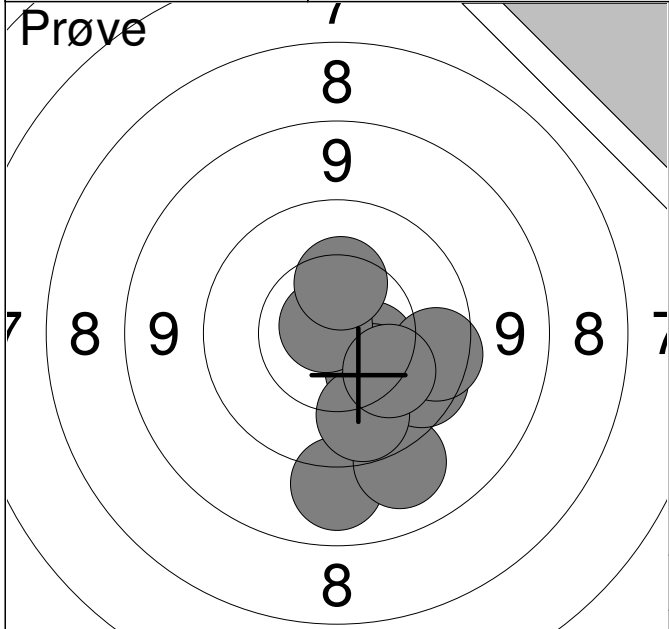
| | | | |
|--|-------|-------|-------|
| Prøve  | 1: | 9.1 | ↓ |
| | 2: | 9.2 | ↓ |
| | 3: | 9.8 | ↓ |
| | 4: | 10.5 | ↓ |
| | 5: | 9.8 | → |
| | 6: | 10.4 | ↓ |
| | 7: | *10.8 | ↗ |
| | 8: | 10.4 | ↑ |
| | 9: | 10.0 | ↓ |
| | 10: | 10.2 | ↓ |
| | Serie | | |
| Total | | | 399.0 |

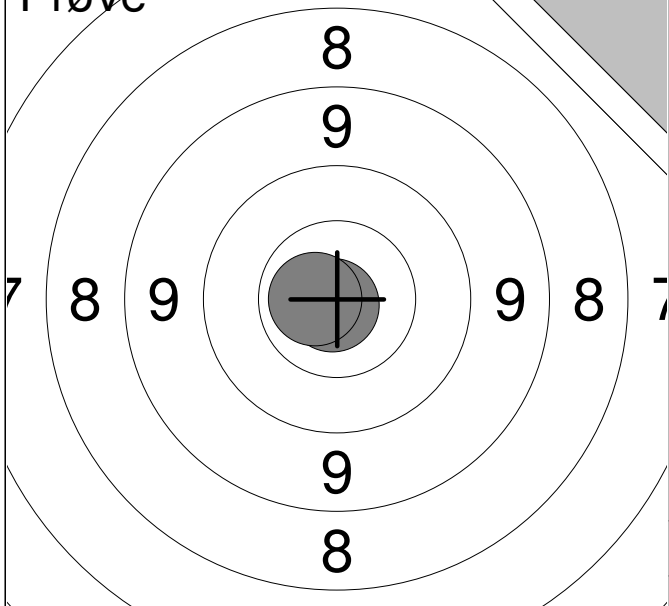
| | | | |
|---|-------|-------|-------|
| Prøve  | 11: | *10.9 | ↙ |
| | 12: | *10.7 | ← |
| | Serie | | |
| Total | | | 399.0 |

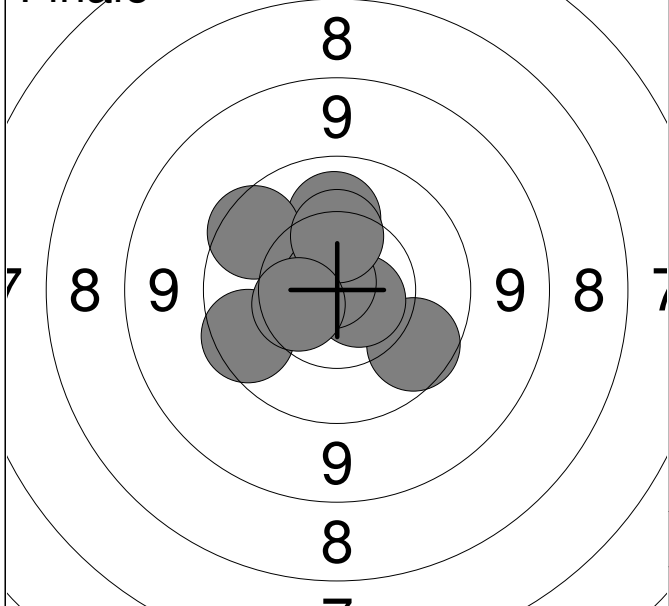
| | | | |
|---|-------|-------|-------|
| Finale  | 1: | 9.9 | ↘ |
| | 2: | *10.8 | ← |
| | 3: | *10.6 | ↗ |
| | 4: | *10.7 | ↘ |
| | 5: | 10.1 | ↑ |
| | 6: | 9.8 | ↗ |
| | 7: | *10.8 | ↗ |
| | 8: | 9.8 | ↙ |
| | 9: | 10.3 | ↑ |
| | 10: | 10.5 | ↙ |
| | Serie | | |
| Total | | | 502.3 |

Hold
32

Skive
10

Christian S. Nielsen

Vilsted Skf.

FBL

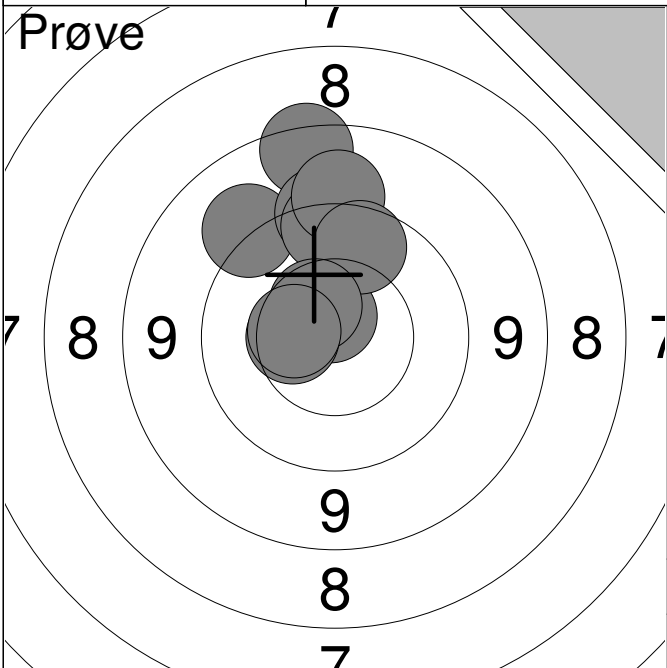

| | | |
|-----|-------|---|
| 1: | 8.6 | ↑ |
| 2: | *10.7 | ↑ |
| 3: | 9.3 | ↗ |
| 4: | 9.5 | ↑ |
| 5: | 9.6 | ↑ |
| 6: | 9.3 | ↑ |
| 7: | 9.9 | ↑ |
| 8: | 10.5 | ↖ |
| 9: | 10.5 | ← |
| 10: | 10.5 | ← |

| | |
|-------|-------|
| Serie | 98.4 |
| Total | 399.0 |

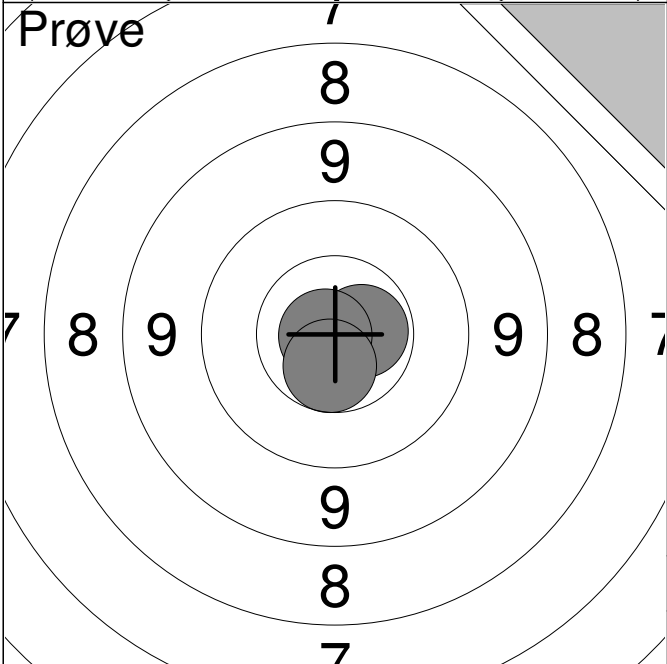

| | | |
|-----|-------|---|
| 11: | *10.6 | → |
| 12: | *10.8 | ← |
| 13: | 10.6 | ↓ |

| | |
|-------|-------|
| Serie | 32.0 |
| Total | 399.0 |

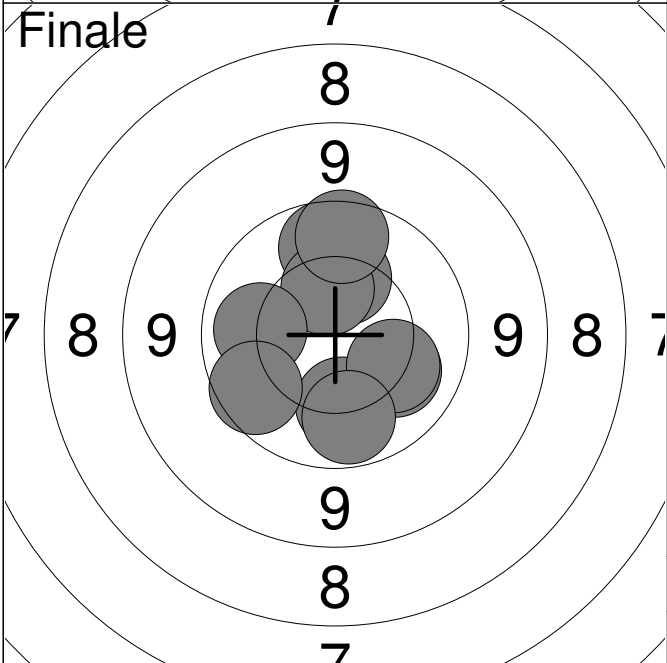

| | | |
|-----|------|---|
| 1: | 10.3 | ↑ |
| 2: | 9.9 | ↑ |
| 3: | 10.1 | ↓ |
| 4: | 10.4 | ↑ |
| 5: | 10.1 | ← |
| 6: | 10.1 | ↘ |
| 7: | 9.8 | ↖ |
| 8: | 10.2 | ↘ |
| 9: | 10.0 | ↓ |
| 10: | 9.8 | ↑ |

| | |
|-------|-------|
| Serie | 100.7 |
| Total | 499.7 |

Hold
32

Skive
11

Kasper Schultz

Vester Hassing Skf.

FBL

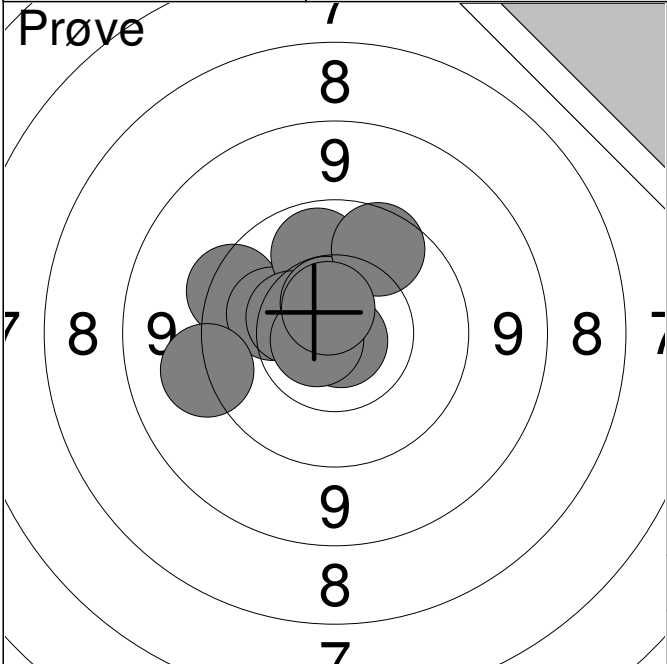

| | | |
|-----|-------|---|
| 1: | 9.6 | ↗ |
| 2: | 10.2 | ↖ |
| 3: | 9.4 | ↙ |
| 4: | 10.0 | ↗ |
| 5: | 10.4 | ↗ |
| 6: | *10.8 | ↘ |
| 7: | *10.6 | ↗ |
| 8: | 9.8 | ↗ |
| 9: | *10.7 | ↙ |
| 10: | *10.6 | ↗ |

| | |
|-------|-------|
| Serie | 102.1 |
| Total | 399.0 |

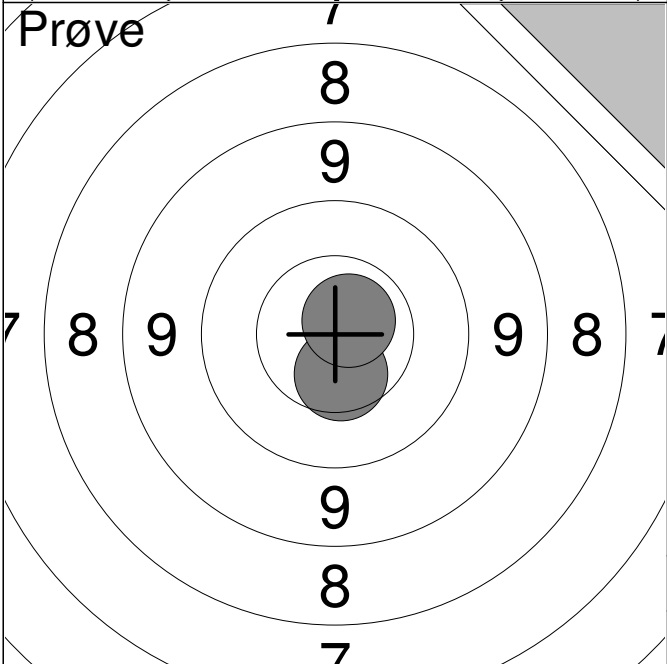

| | | |
|-----|-------|---|
| 11: | 10.5 | ↘ |
| 12: | *10.7 | ↗ |

| | |
|-------|-------|
| Serie | 21.2 |
| Total | 399.0 |

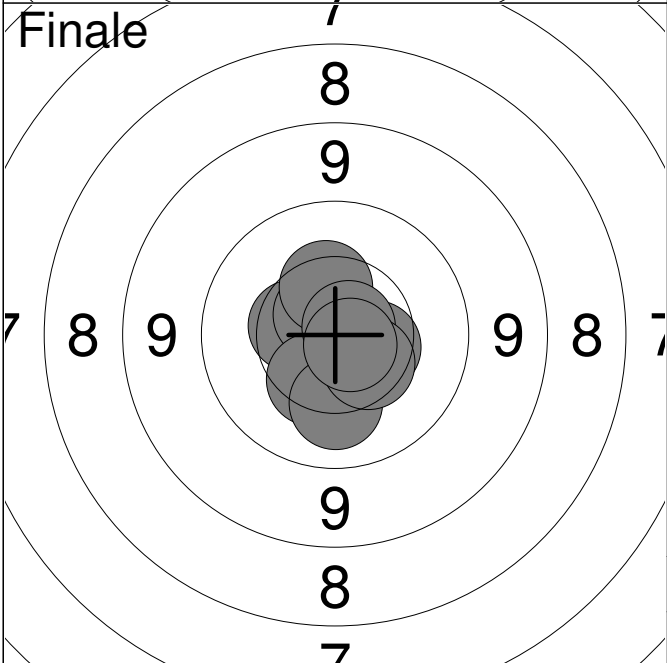

| | | |
|-----|-------|---|
| 1: | 10.5 | ↖ |
| 2: | *10.7 | ↗ |
| 3: | 10.4 | ↙ |
| 4: | 10.4 | ↗ |
| 5: | 10.6 | ↘ |
| 6: | 10.5 | ↘ |
| 7: | 10.2 | ↘ |
| 8: | *10.8 | ↗ |
| 9: | 10.5 | ↘ |
| 10: | *10.7 | ↘ |

| | |
|-------|-------|
| Serie | 105.3 |
| Total | 504.3 |

Hold
32

Skive
12

Mathias Christensen

Vilsted Skf.

FBL

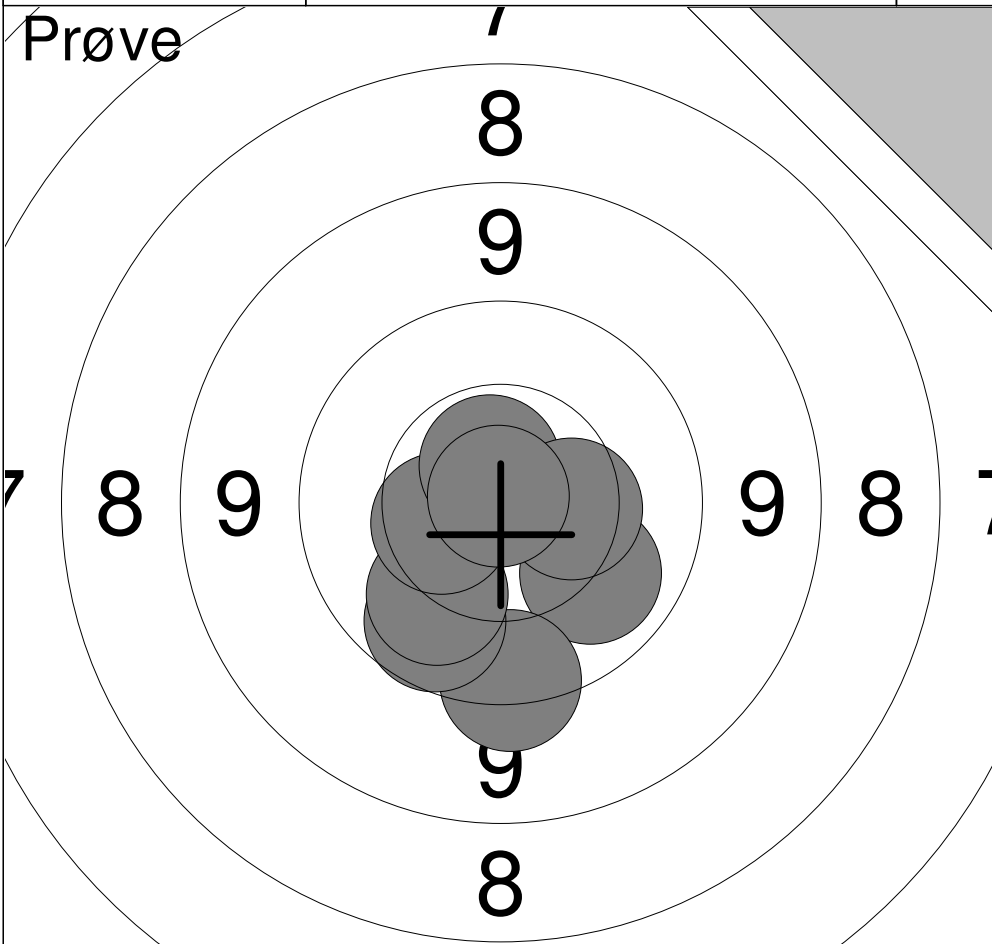

| | | |
|----|-------|---|
| 1: | 10.1 | ↘ |
| 2: | 9.6 | ↓ |
| 3: | 9.9 | ↙ |
| 4: | 10.1 | ↘ |
| 5: | 10.5 | ↖ |
| 6: | *10.7 | ↑ |
| 7: | 10.4 | → |
| 8: | *10.9 | ↗ |

| | |
|-------|-------|
| Serie | 82.2 |
| Total | 399.0 |

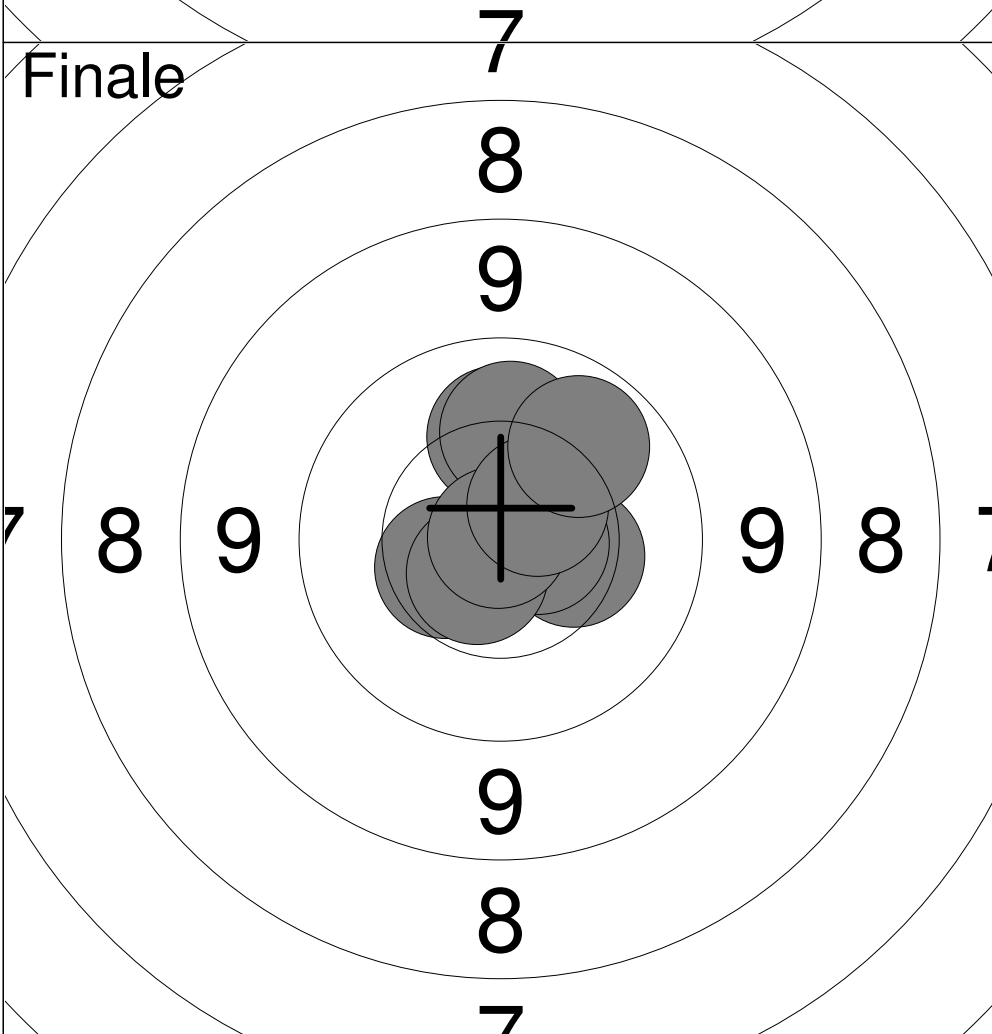

| | | |
|-----|-------|---|
| 1: | 10.2 | ↑ |
| 2: | 10.4 | → |
| 3: | *10.7 | → |
| 4: | 10.5 | ↖ |
| 5: | 10.4 | ↗ |
| 6: | 10.1 | ↑ |
| 7: | *10.6 | ↙ |
| 8: | *10.9 | ↗ |
| 9: | 10.6 | ↗ |
| 10: | 10.0 | ↗ |

| | |
|-------|-------|
| Serie | 104.4 |
| Total | 503.4 |